

| | Article-No. | Description | Page | Qty. |
|-----------|-------------|---|------|-------|
| 1 | 253-804-030 | RZ Cystoscope 4.0mm Ø, 30° direction of view | 19 | 1 pc. |
| 2 | 253-300-017 | Cysto-Urethroscope Sheath 17 Charr. | 20 | 1 pc. |
| 3 | 253-300-022 | Cysto-Urethroscope Sheath 22 Charr. | 20 | 1 pc. |
| 4 | 253-000-102 | Bridge with 2 channels for 1 instrument with max. 12 Charr. or 2 instruments with max. 8 Charr. | 22 | 1 pc. |
| 5 | 253-000-105 | Albaran deflecting mechanism with 2 working channels and ratchet | 22 | 1 pc. |
| 6 | 351-114-107 | Flexible Grasping Forceps, serrated jaws, double action | 23 | 1 pc. |
| 7 | 351-120-107 | Biopsy Forceps, oval cup, serrated jaws, double action | 23 | 1 pc. |
| 8 | 351-100-105 | Scissors, single action | 23 | 1 pc. |
| 9 | 253-420-100 | Spoon Biopsy Forceps with round cup, double action | 24 | 1 pc. |
| 10 | 253-585-005 | Dormia Metal Stone Basket, flexible, 4 wires, 600mm working length, 5 Charr. | 26 | 1 pc. |
| 11 | 253-370-005 | Ball Electrode 530mm working length, 5 Charr. | 28 | 1 pc. |
| 12 | 253-370-007 | Ball Electrode 530mm working length, 7 Charr. | 28 | 1 pc. |
| 13 | 253-610-003 | Monopolar Cable with 8 mm plug for Valleylab HF-unit | 28 | 1 pc. |
| 14 | 253-500-000 | Ellik Evacuator with turn lock connection | 106 | 1 pc. |
| 15 | 253-000-950 | Bladder Syringe, 150cc | 105 | 1 pc. |

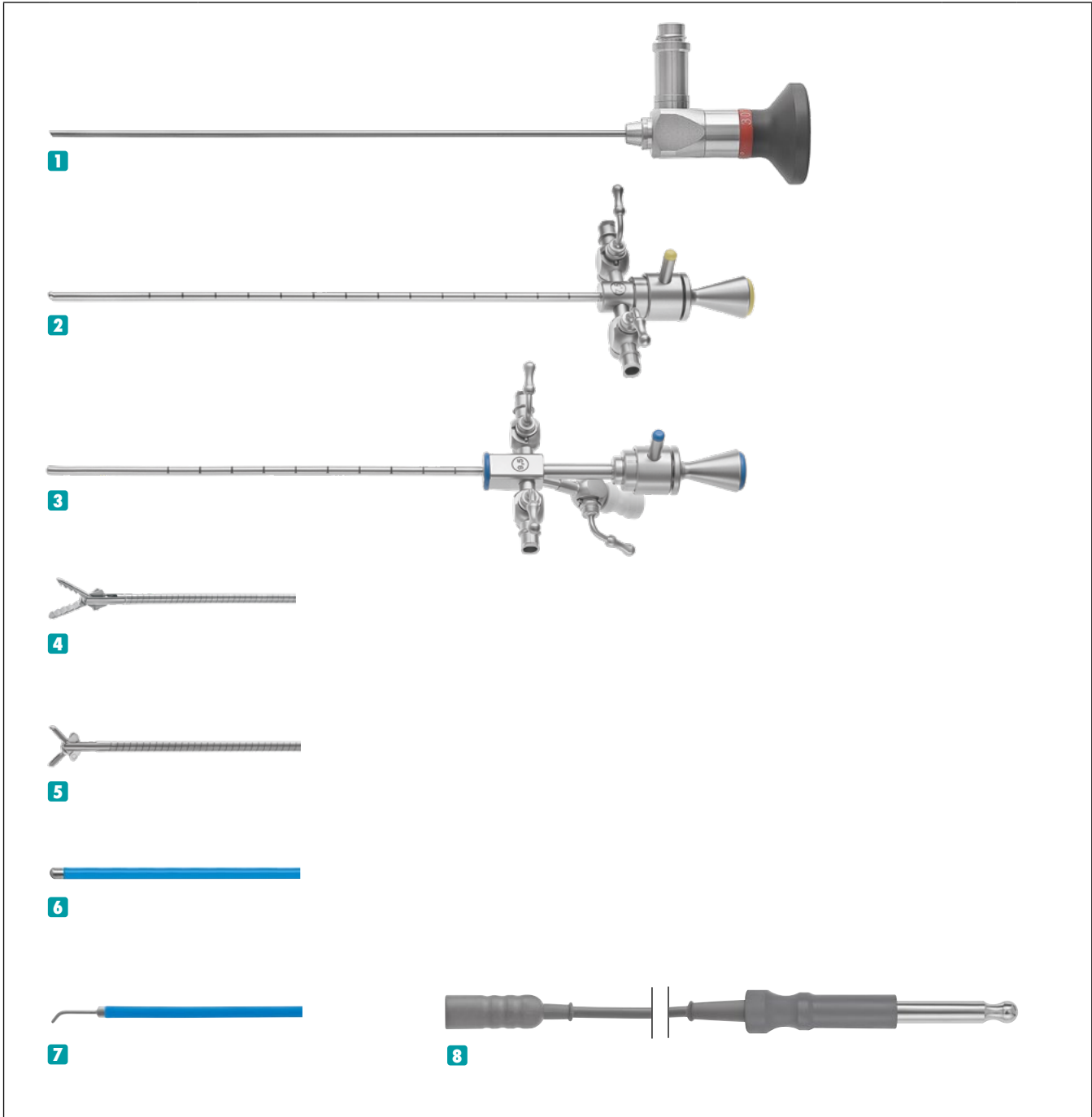

| | Article-No. | Description | Page | Qty. |
|----------|-------------|--|------|-------|
| 1 | 253-219-130 | RZ Pediatric Fiber Cystoscope Ø 2.0mm, 30° direction of view | 75 | 1 pc. |
| 2 | 253-200-075 | Pediatric Cystoscope Sheath 7.5 Charr. | 75 | 1 pc. |
| 3 | 253-200-095 | Pediatric Cystoscope Sheath 9.5 Charr. | 75 | 1 pc. |
| 4 | 253-202-003 | Alligator grasping forceps, 28cm length, 3 Charr. | 75 | 1 pc. |
| 5 | 253-204-003 | Biopsy forceps, 28cm length, 3 Charr. | 75 | 1 pc. |
| 6 | 253-370-253 | Ball electrode, 25cm length, 3 Charr. | 75 | 1 pc. |
| 7 | 253-371-253 | Needle electrode, 25cm length, 3 Charr. | 75 | 1 pc. |
| 8 | 253-610-003 | Monopolar Cable with 8 mm plug for Valleylab HF-unit | 83 | 1 pc. |

Cystoscope Set for (newborn) Babys

253-900-919

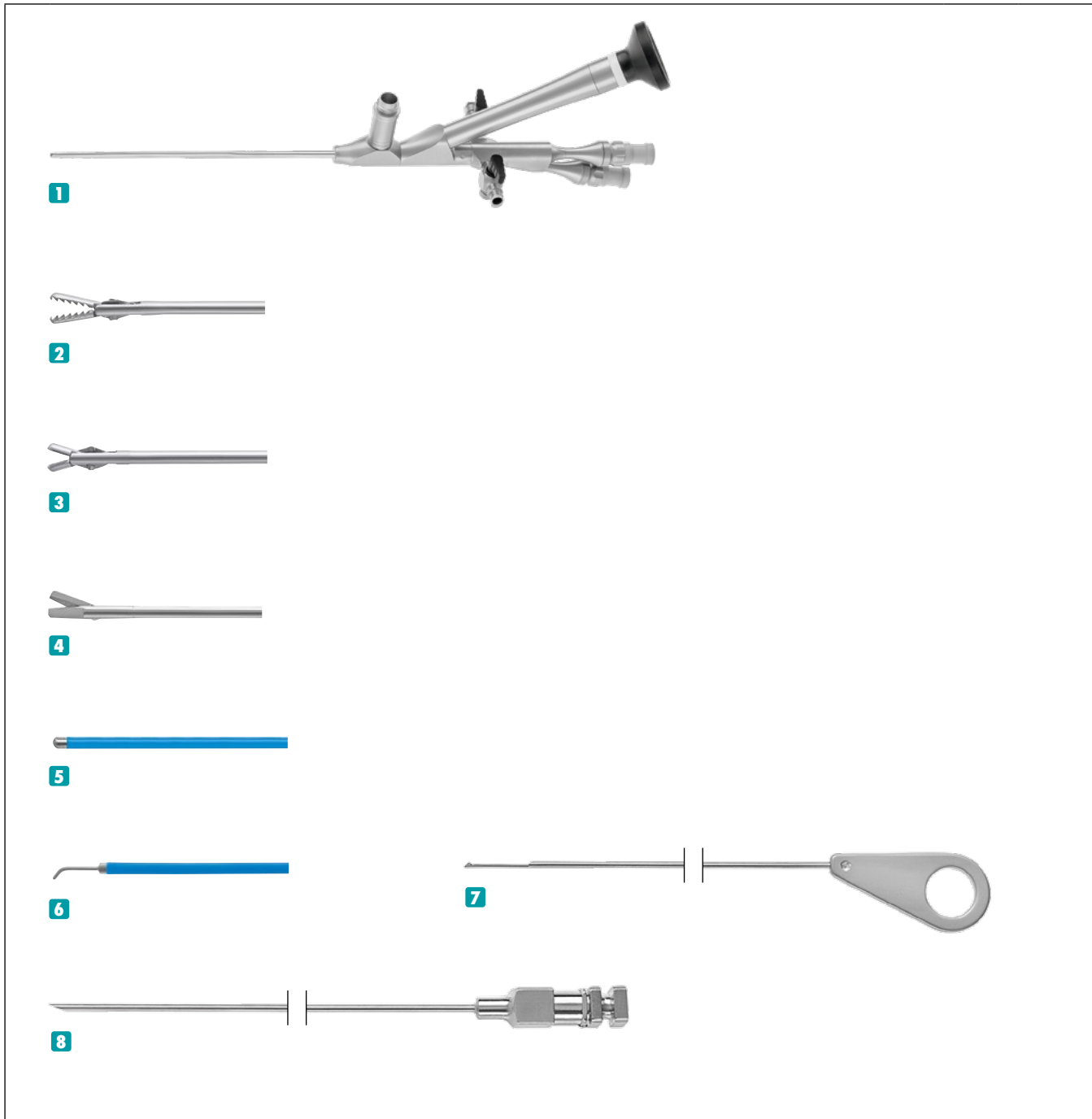

| | Article-No. | Description | Page | Qty. |
|----------|-------------|--|------|-------|
| 1 | 253-200-600 | Operating Cysto-Urethrotome 4.5 Charr., 5° direction of view | 72 | 1 pc. |
| 2 | 253-203-128 | Stone Grasping Forceps, double action, 3 Charr. | 72 | 1 pc. |
| 3 | 253-203-328 | Biopsy Forceps, double action, 3 Charr. | 72 | 1 pc. |
| 4 | 253-203-428 | Scissors, single action, 3 Charr. | 72 | 1 pc. |
| 5 | 253-370-253 | Ball Electrode, 3 Charr. | 72 | 1 pc. |
| 6 | 253-371-253 | Needle electrode, 3 Charr. | 72 | 1 pc. |
| 7 | 253-200-200 | Hook Knife, 3 Charr. | 72 | 1 pc. |
| 8 | 253-200-210 | Injection Cannula, 3 Charr. | 72 | 1 pc. |

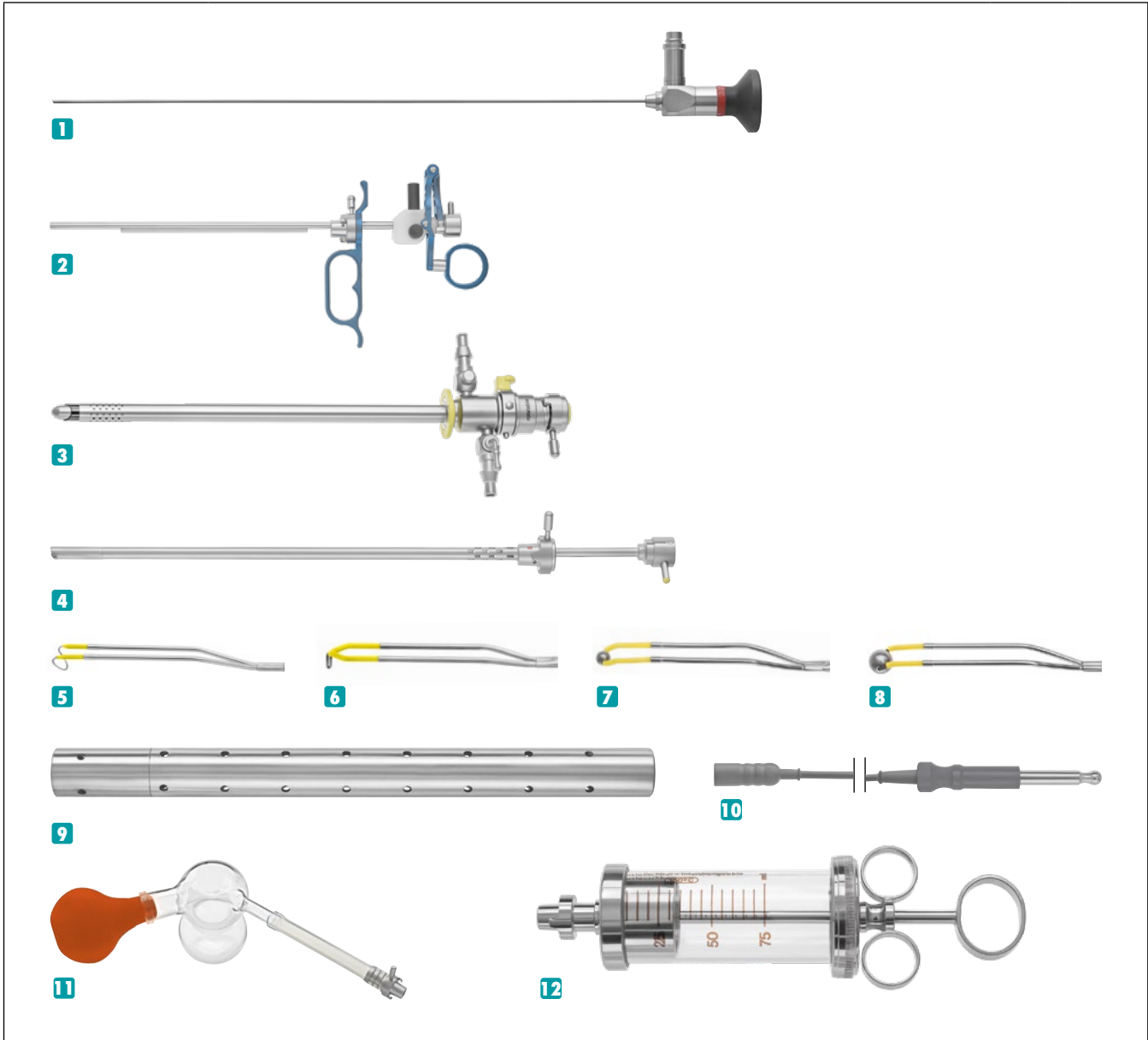

| | Article-No. | Description | Page | Qty. |
|-----------|-------------|--|------|--------|
| 1 | 253-804-030 | RZ Cystoscope 4.0mm Ø, 30° direction of view | 19 | 1 pc. |
| 2 | 253-000-200 | Passive Titanium working element | 34 | 1 pc. |
| 3 | 253-000-256 | Continuous Flow Resectoscope Sheath, 26 Charr. | 40 | 1 pc. |
| 4 | 253-000-084 | Visual Obturator for 4mm RZ Cystoscopes | 42 | 1 pc. |
| 5 | 253-300-201 | Cutting Loop, angled, for 12°/30° telescope | 35 | 3 pcs. |
| 6 | 253-300-203 | Coagulation Electrode, pointed | 35 | 1 pc. |
| 7 | 253-300-205 | Coagulation Electrode, ball shape, Ø 3mm | 35 | 1 pc. |
| 8 | 253-300-206 | Coagulation Electrode, ball shape, Ø 5mm | 35 | 1 pc. |
| 9 | 253-300-999 | Storage container for knives and electrodes, metal, perforated | 63 | 1 pc. |
| 10 | 253-610-003 | Monopolar Cable with 8 mm plug for Valleylab HF-unit | 83 | 1 pc. |
| 11 | 253-500-000 | Ellik Evacuator with turn lock connection | 106 | 1 pc. |
| 12 | 253-000-950 | Bladder Syringe, 150cc | 105 | 1 pc. |

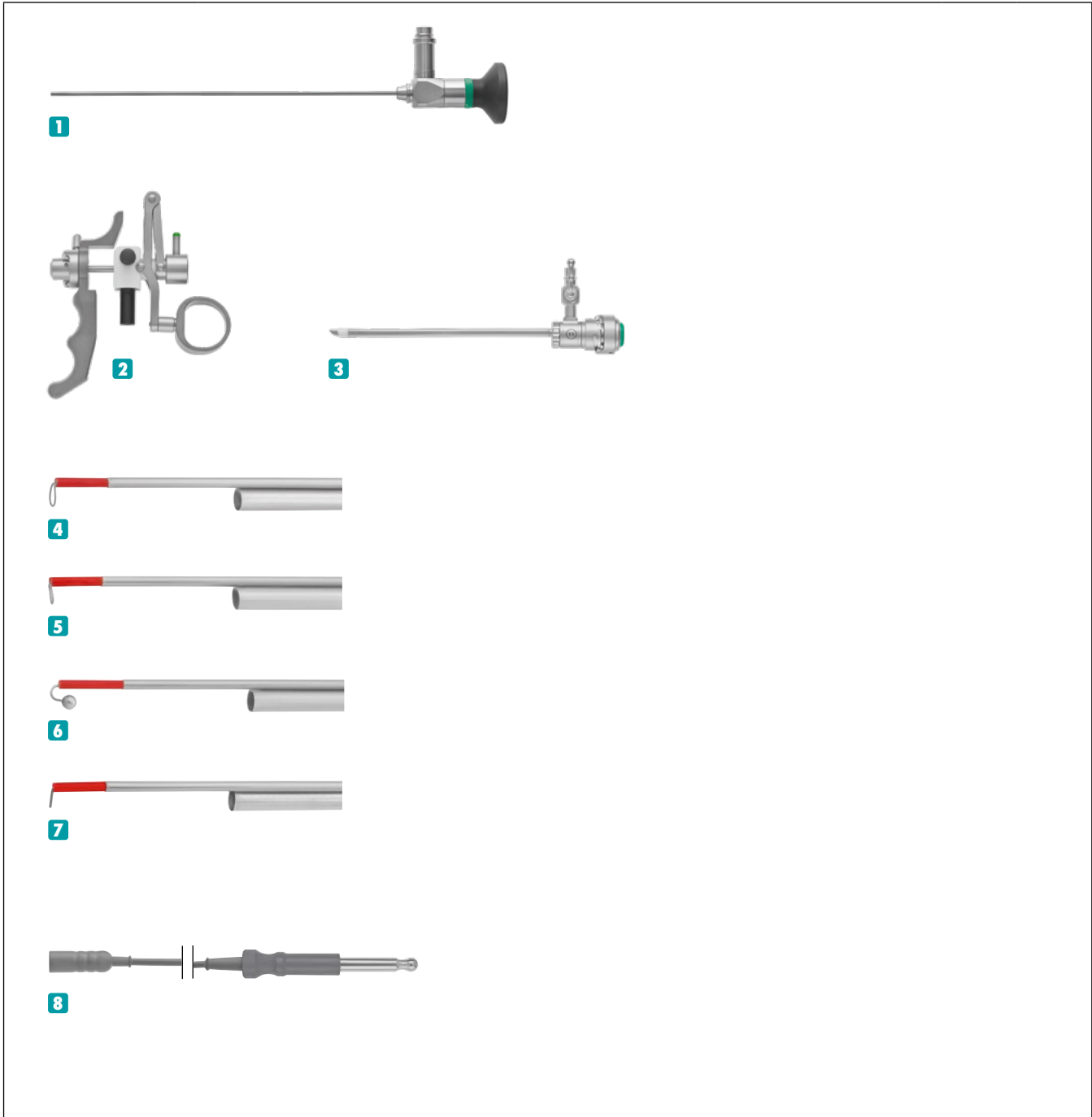

| | Article-No. | Description | Page | Qty. |
|----------|-------------|--|------|-------|
| 1 | 253-219-100 | RZ Pediatric Fiber Cystoscope \varnothing 2.0mm | 75 | 1 pc. |
| 2 | 253-250-200 | Passive Titanium working element | 78 | 1 pc. |
| 3 | 253-250-211 | Resectoscope Sheath 11 Charr. with obturator | 78 | 1 pc. |
| 4 | 253-251-111 | Cutting Loop Electrode, 11 Charr. | 78 | 1 pc. |
| 5 | 253-251-112 | Coagulation Electrode, 11 Charr. | 78 | 1 pc. |
| 6 | 253-251-113 | Hook Electrode with ball, 11 Charr. | 78 | 1 pc. |
| 7 | 253-251-115 | Needle Electrode, pointed, 11 Charr. | 78 | 1 pc. |
| 8 | 253-610-003 | Monopolar Cable with 8 mm plug for Valleylab HF-unit | 83 | 1 pc. |

26 Charr. Bipolar (HYBRID) Resectoscope Set for adults

253-900-911

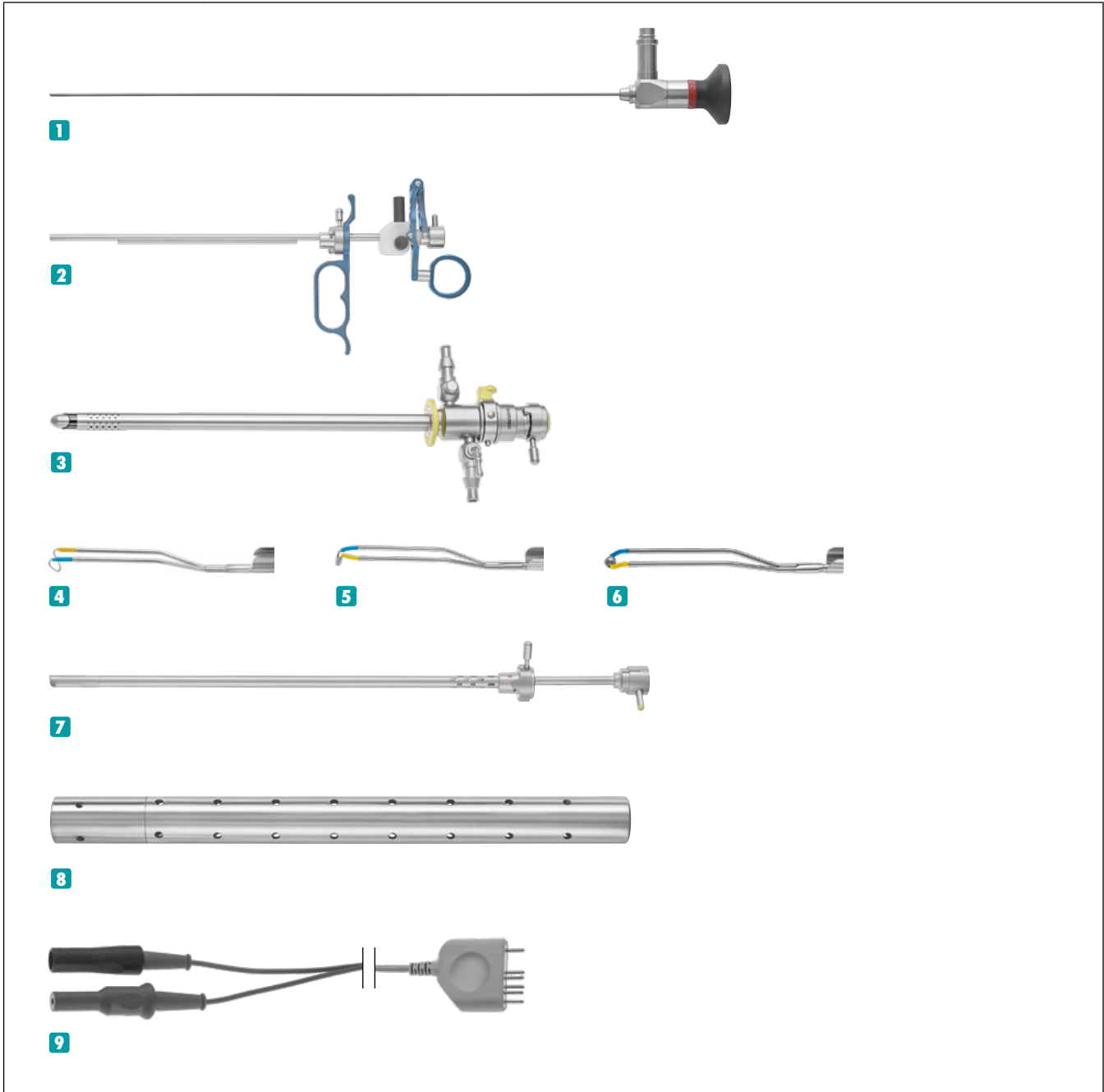

| | Article-No. | Description | Page | Qty. |
|----------|-------------|---|------|-------|
| 1 | 253-804-030 | RZ Cystoscope, 30°, Ø 4mm | 19 | 1 pc. |
| 2 | 253-000-400 | Passive HYBRID working element | 38 | 1 pc. |
| 3 | 253-000-256 | Continuous Flow Resectoscope Sheath, 26 Charr. | 41 | 1 pc. |
| 4 | 253-400-201 | Cutting Electrode | 39 | 1 pc. |
| 5 | 253-400-203 | Collins Coagulation Electrode | 39 | 1 pc. |
| 6 | 253-400-205 | Ball Electrode | 39 | 1 pc. |
| 7 | 253-000-094 | Visual Obturator, with 6 Charr. working channel | 42 | 1 pc. |
| 8 | 253-300-999 | Sterilization tubes for electrodes | 63 | 1 pc. |
| 9 | 700-500-453 | SDS Cable, 4.5m, bipolar | 38 | 1 pc. |

18.5 Charr. Bipolar (HYBRID) Resectoscope Set for adults and adolescents

253-900-921

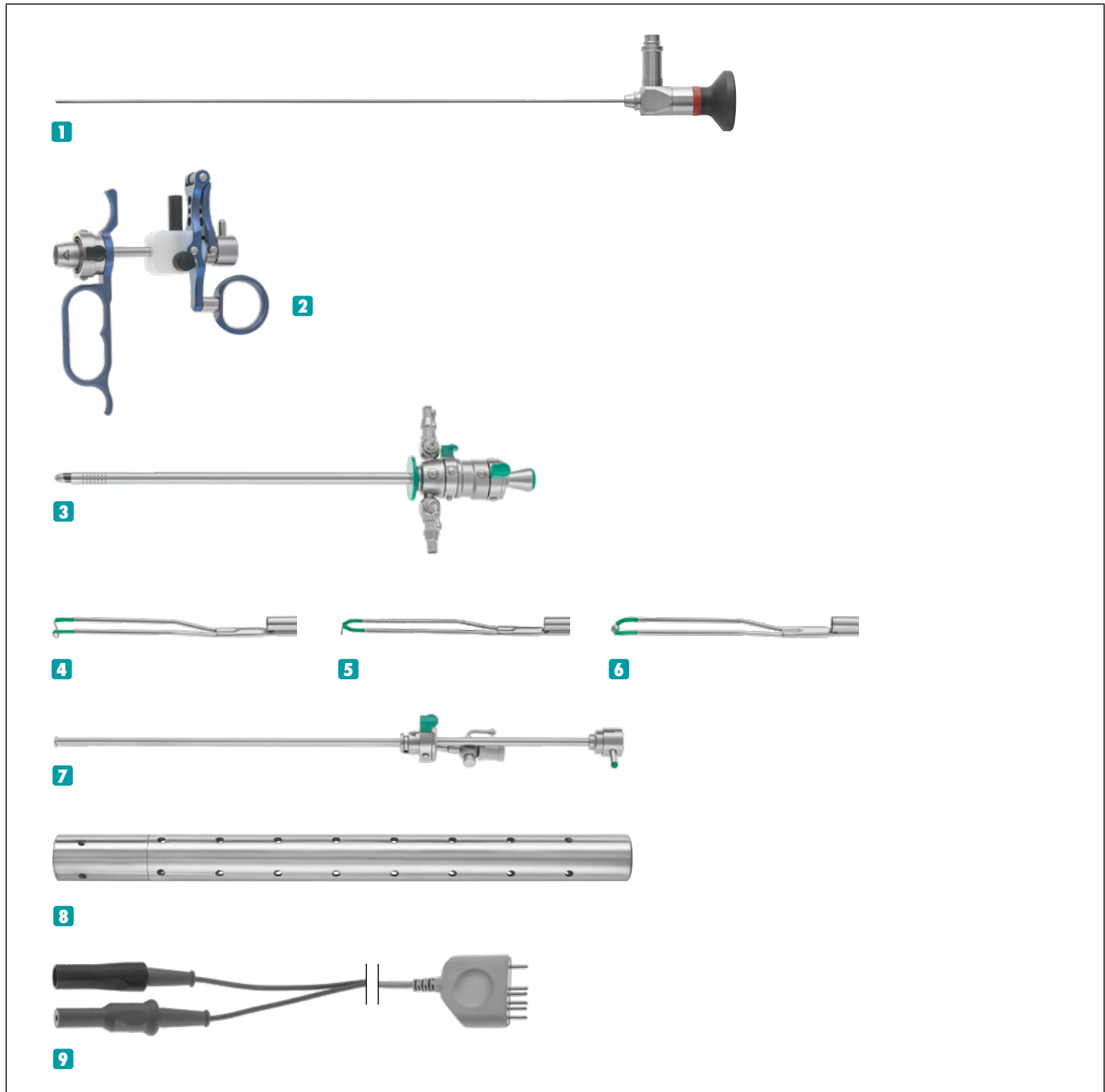

| | Article-No. | Description | Page | Qty. |
|----------|-------------|--|------|-------|
| 1 | 253-829-030 | RZ Cystoscope, 30°, Ø 2.9mm | 82 | 1 pc. |
| 2 | 351-400-200 | Passive HYBRID working element | 85 | 1 pc. |
| 3 | 351-000-185 | Continuous Flow Resectoscope Sheath, 18.5 Charr. | 85 | 1 pc. |
| 4 | 351-000-201 | Loop Electrode | 85 | 1 pc. |
| 5 | 351-000-203 | Knife Electrode | 85 | 1 pc. |
| 6 | 351-000-205 | Ball Electrode | 85 | 1 pc. |
| 7 | 351-000-180 | Visual Obturator, with 5 Charr. working channel | 85 | 1 pc. |
| 8 | 253-300-999 | Sterilization tubes for electrodes | 63 | 1 pc. |
| 9 | 700-500-453 | SDS Cable, 4.5m, bipolar | 38 | 1 pc. |

HoLEP Set acc. Dr. Felipe C. A. de Figueiredo

253-900-920

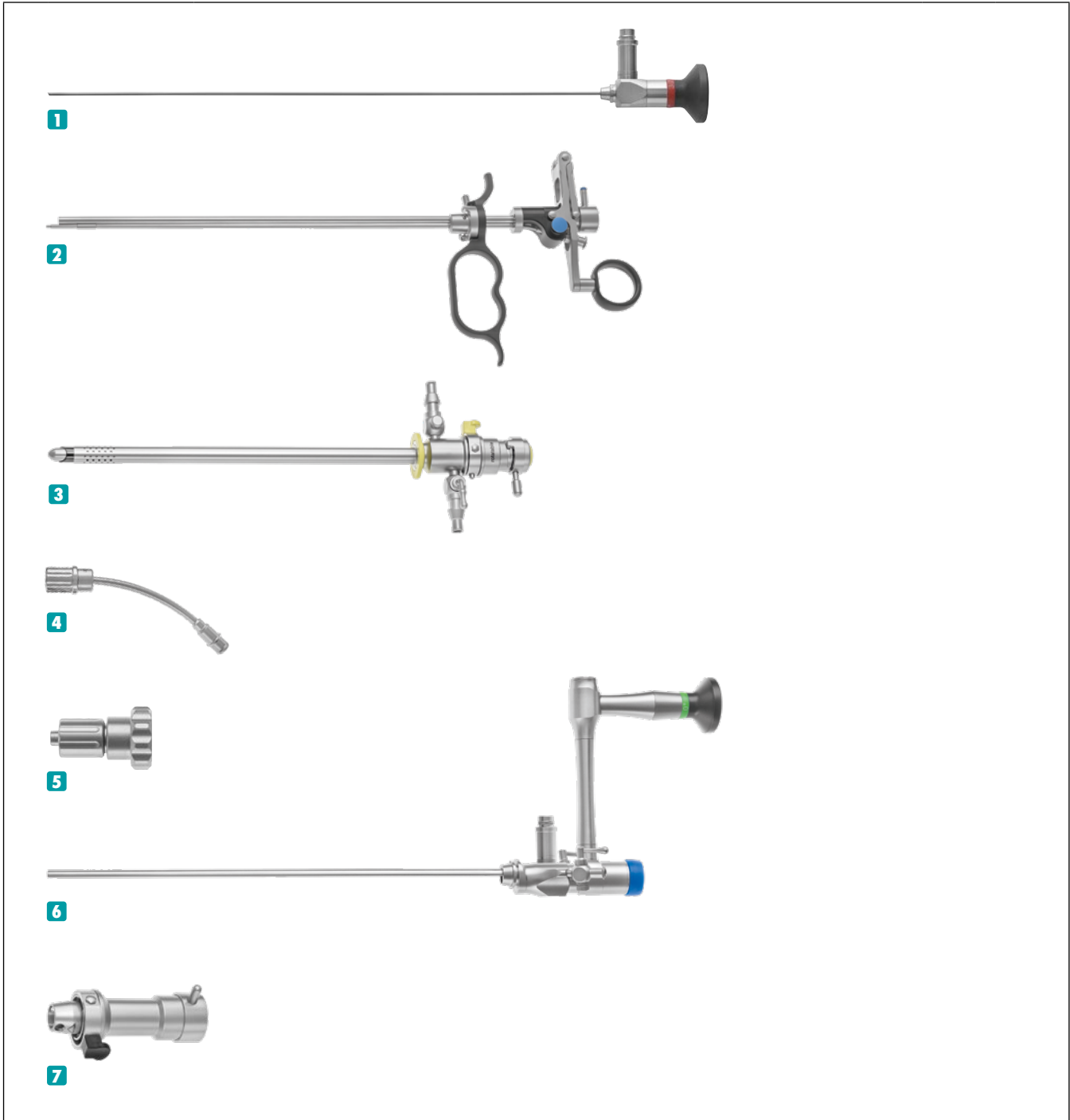

| | Article-No. | Description | Page | Qty. |
|----------|-------------|---|------|-------|
| 1 | 253-804-030 | RZ Cystoscope 4.0mm Ø, 30° direction of view | 19 | 1 pc. |
| 2 | 253-000-312 | RZ Laser Working Element, passive, for laser-probes | 54 | 1 pc. |
| 3 | 253-000-256 | Continous Flow Resectoscope Sheath, 26 Charr. | 54 | 1 pc. |
| 4 | 253-000-302 | RZ LL-Connection | 54 | 1 pc. |
| 5 | 300-011-184 | Luer-Lock Tuohy Borst Adapter | 54 | 1 pc. |
| 6 | 253-900-121 | Nephroscope 6° | 58 | 1 pc. |
| 7 | 253-428-100 | Adapter for Resectoscope outer sheath 253-000-256 | 58 | 1 pc. |

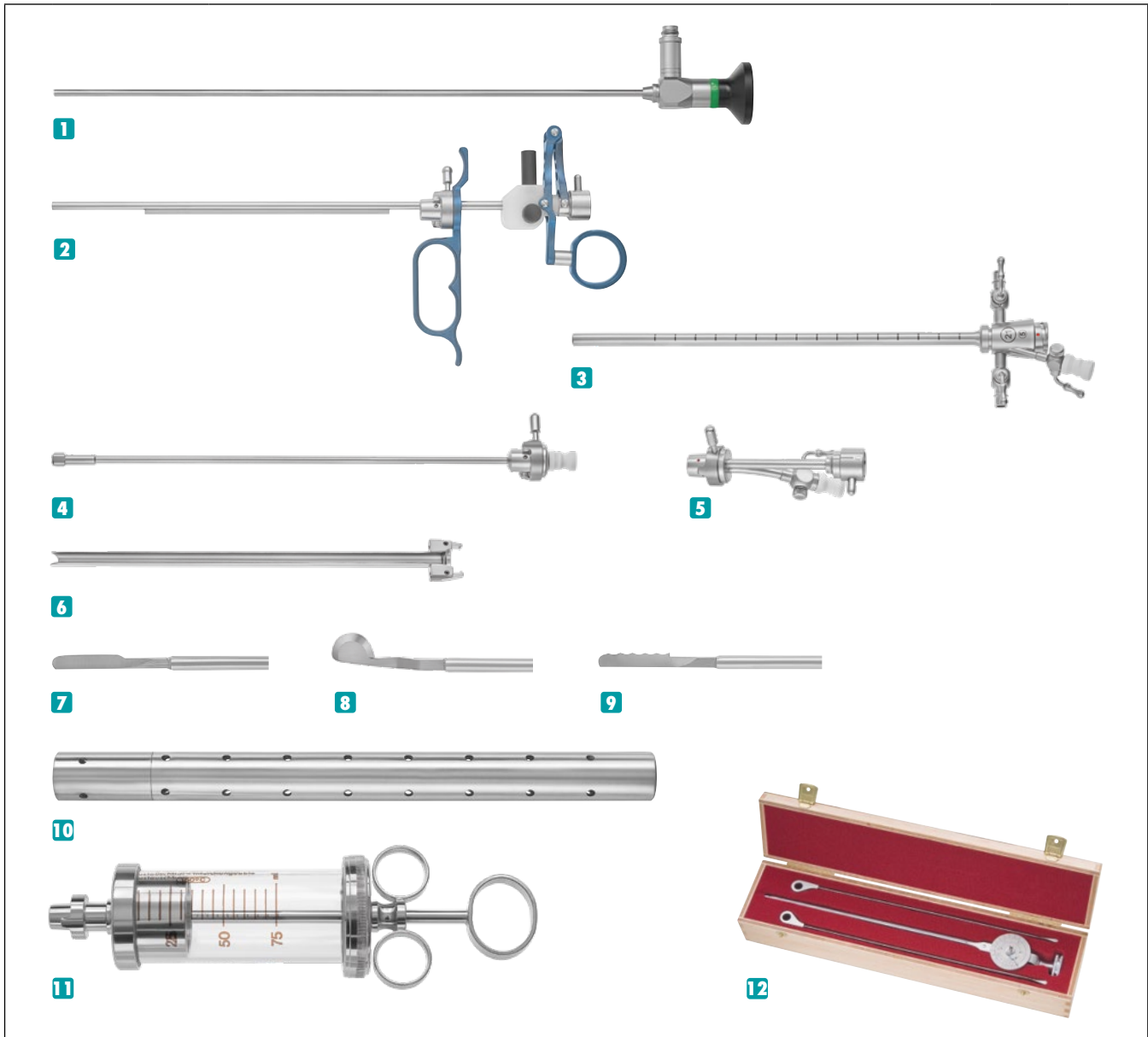

| | Article-No. | Description | Page | Qty. |
|-----------|-------------|---|------|--------|
| 1 | 253-804-000 | RZ Cystoscope 4.0mm Ø, 0° direction of view | 62 | 1 pc. |
| 2 | 253-000-200 | Passive Titanium Working Element | 62 | 1 pc. |
| 3 | 253-500-221 | Urethrotome Sheath oval shape, 21 Charr. | 62 | 1 pc. |
| 4 | 253-500-321 | Hollow Obturator with channel for guide wires | 62 | 1 pc. |
| 5 | 253-500-325 | Bridge with channel for 5 Charr. accessories | 62 | 1 pc. |
| 6 | 253-500-230 | Supplementary Sheath, half round | 62 | 1 pc. |
| 7 | 253-500-561 | Sachse knife, straight | 63 | 3 pcs. |
| 8 | 253-500-563 | Half round knife, 180° cutting | 63 | 2 pcs. |
| 9 | 253-500-564 | WaveCut knife, straight | 63 | 1 pc. |
| 10 | 253-300-999 | Sterilization tubes for electrodes | 63 | 1 pc. |
| 11 | 253-000-950 | Bladder Syringe, 150cc | 105 | 1 pc. |
| 12 | 253-500-100 | OTIS Dilation Urethrotome, complete | 61 | 1 pc. |

Urethrotome Set for children

253-900-922

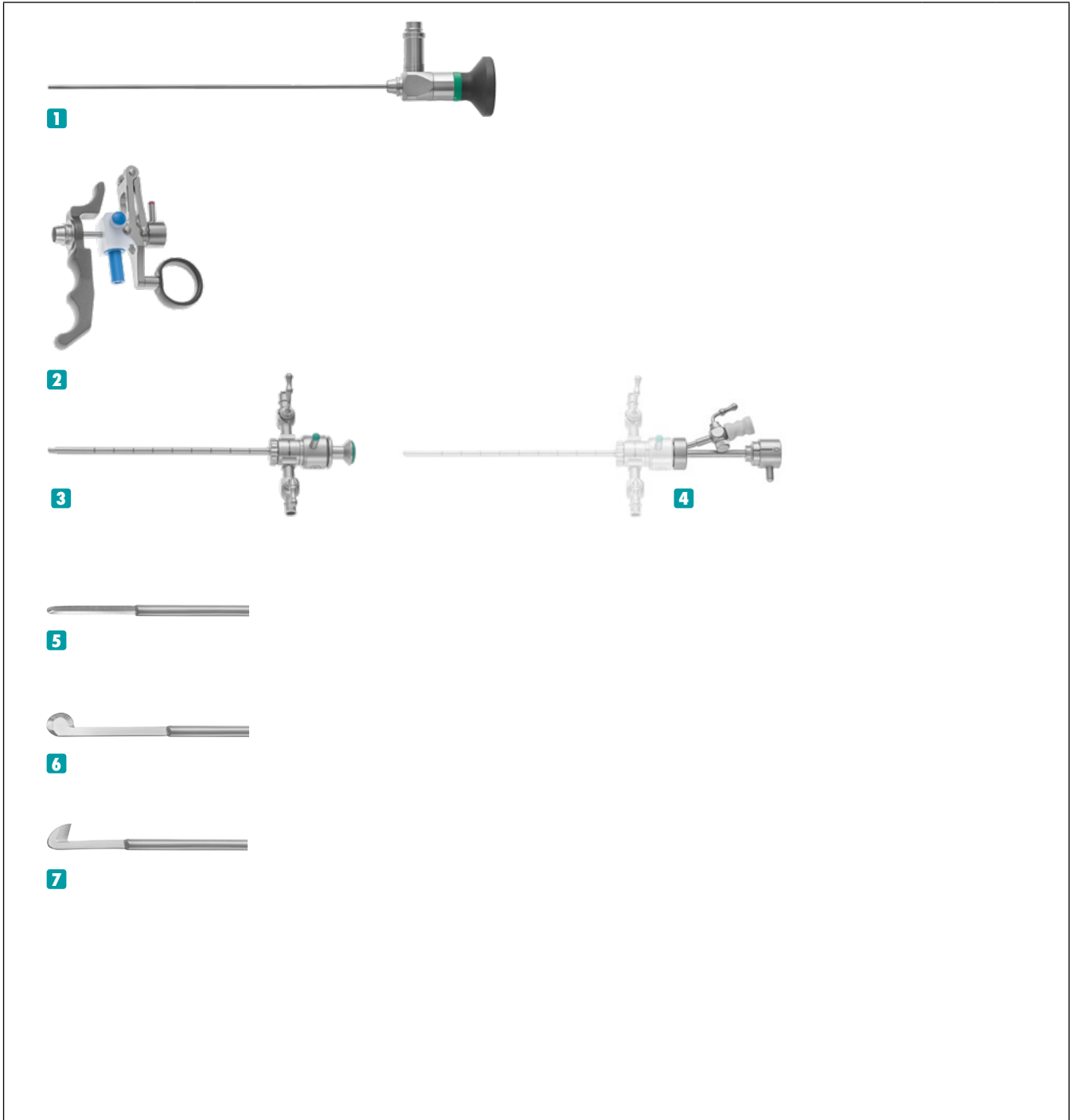

| | Article-No. | Description | Page | Qty. |
|----------|-------------|---|------|-------|
| 1 | 253-219-100 | RZ Pediatric Fiber Cystoscope \varnothing 2.0mm, 0° direction of view | 78 | 1 pc. |
| 2 | 253-250-200 | Passive Working Element | 78 | 1 pc. |
| 3 | 253-265-010 | Pediatric Urethrotome sheath, 10 Charr. | 79 | 1 pc. |
| 4 | 253-255-001 | Bridge with 1 channel | 79 | 1 pc. |
| 5 | 253-265-101 | Knife with straight cutting edge | 79 | 1 pc. |
| 6 | 253-265-102 | Round Knife | 79 | 1 pc. |
| 7 | 253-265-104 | Hook Knife | 79 | 1 pc. |

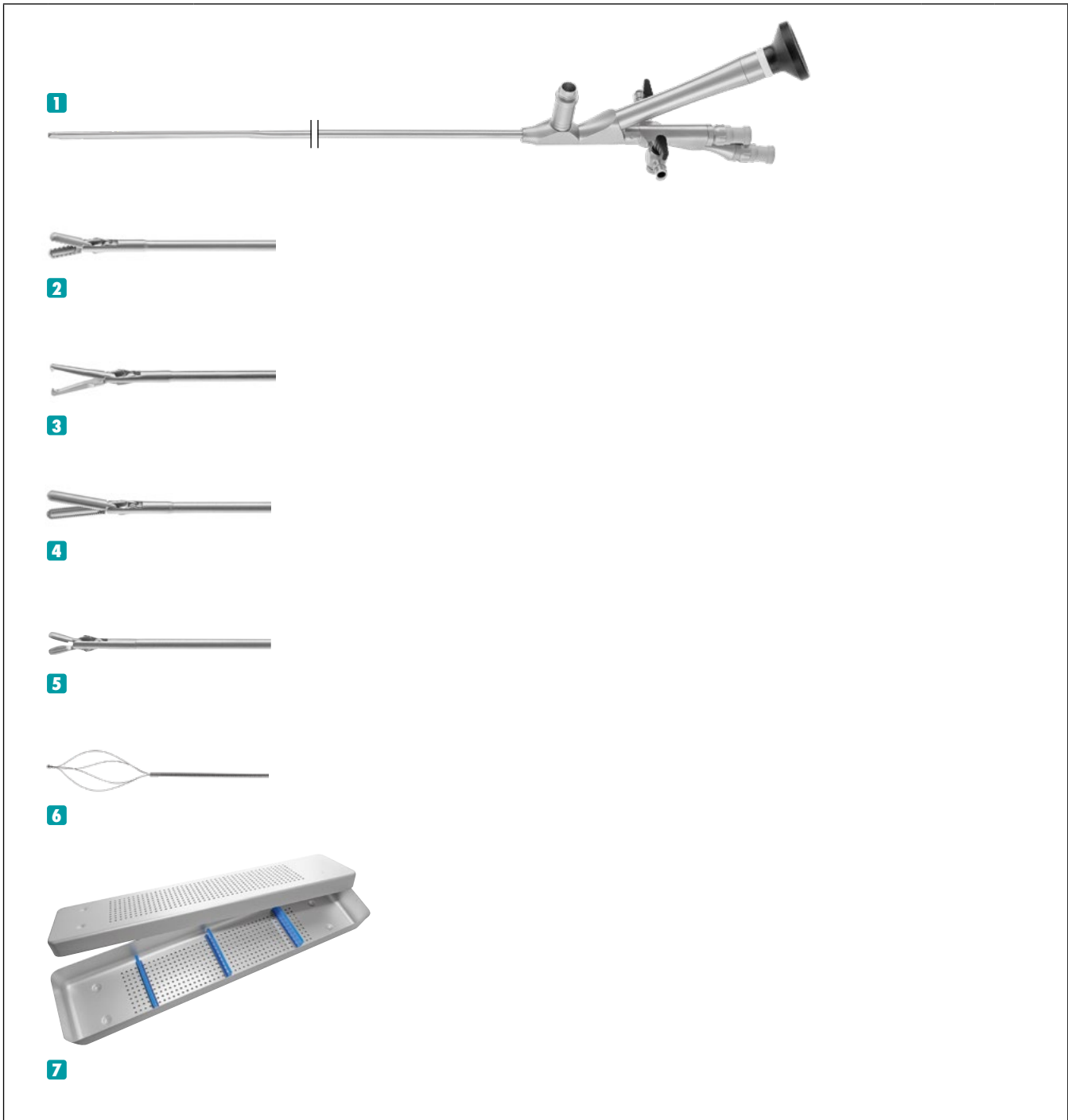

| | Article-No. | Description | Page | Qty. |
|----------|-------------|---|------|-------|
| 1 | 253-905-540 | Advanced Semi-Rigid Uretero-Renoscope | 100 | 1 pc. |
| 2 | 253-950-005 | Stone Grasping Forceps | 101 | 1 pc. |
| 3 | 253-952-005 | Stone Grasping Forceps for large stones | 101 | 1 pc. |
| 4 | 253-954-005 | HAMADA long Stone Grasping Forceps | 101 | 1 pc. |
| 5 | 253-956-005 | Biopsy Forceps | 101 | 1 pc. |
| 6 | 253-585-005 | Dormia Metal Stone Basket, flexible | 101 | 1 pc. |
| 7 | 253-905-000 | Container for URS with silicone inserts | 100 | 1 pc. |

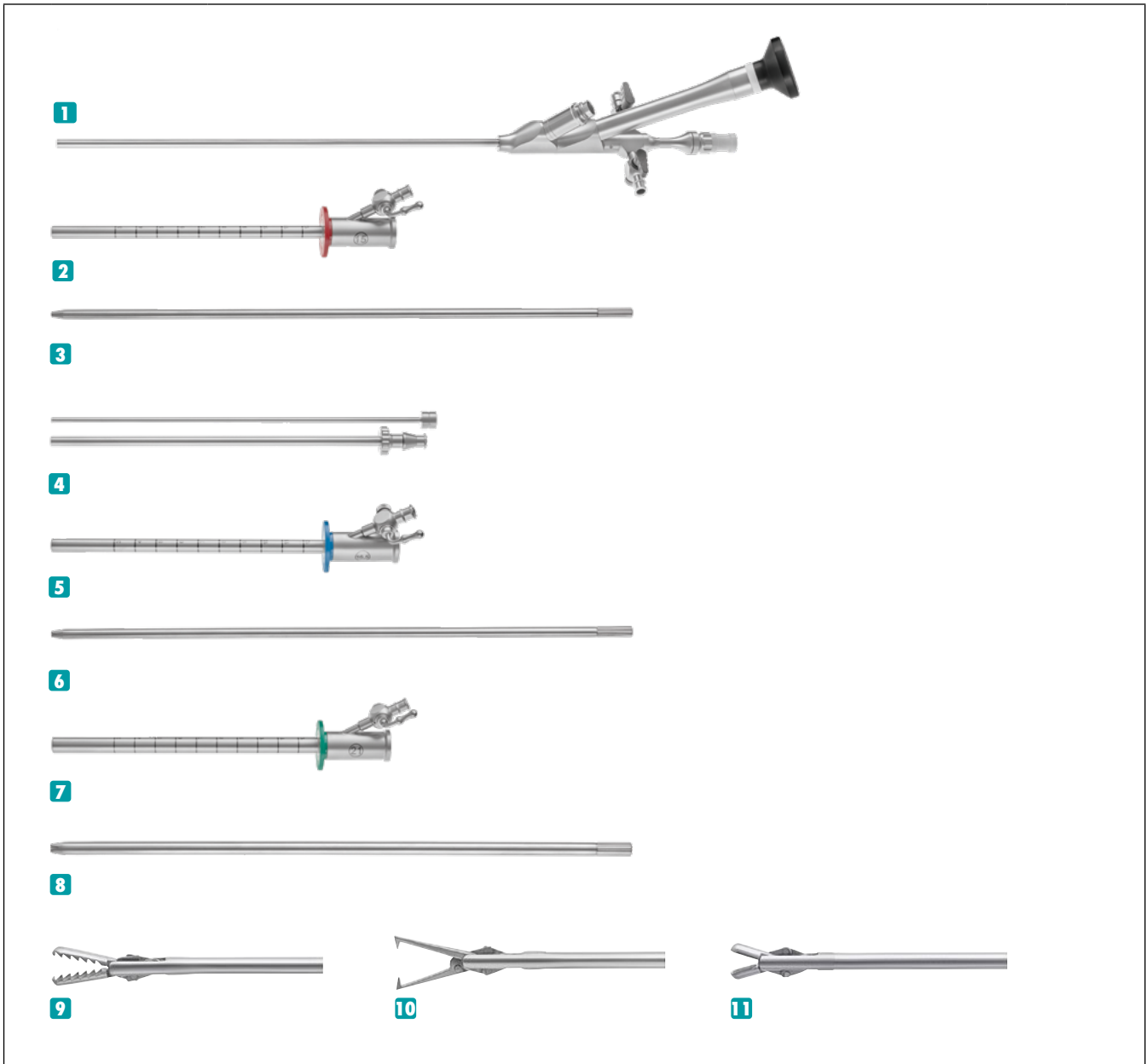

| | Article-No. | Description | Page | Qty. |
|-----------|-------------|---|------|--------|
| 1 | 253-900-140 | Mini Nephroscope, 12° direction of view | 87 | 1 pc. |
| 2 | 253-900-141 | 15 Charr. Nephroscope Sheath | 88 | 1 pc. |
| 3 | 253-900-146 | One-Step Dilator | 88 | 1 pc. |
| 4 | 253-900-145 | 2-piece Sealing Adapter | 88 | 1 pc. |
| 5 | 253-900-142 | 16.5 Charr. Nephroscope Sheath | 88 | 1 pc. |
| 6 | 253-900-147 | One-Step Dilator | 88 | 1 pc. |
| 7 | 253-900-143 | 21 Charr. Nephroscope Sheath | 88 | 3 pcs. |
| 8 | 253-900-148 | One-step Dilator | 88 | 3 pcs. |
| 9 | 253-950-455 | Stone Grasping forceps | 89 | 1 pc. |
| 10 | 253-952-455 | Stone Grasping Forceps for large stones | 89 | 1 pc. |
| 11 | 253-956-455 | Biopsy Forceps | 89 | 1 pc. |

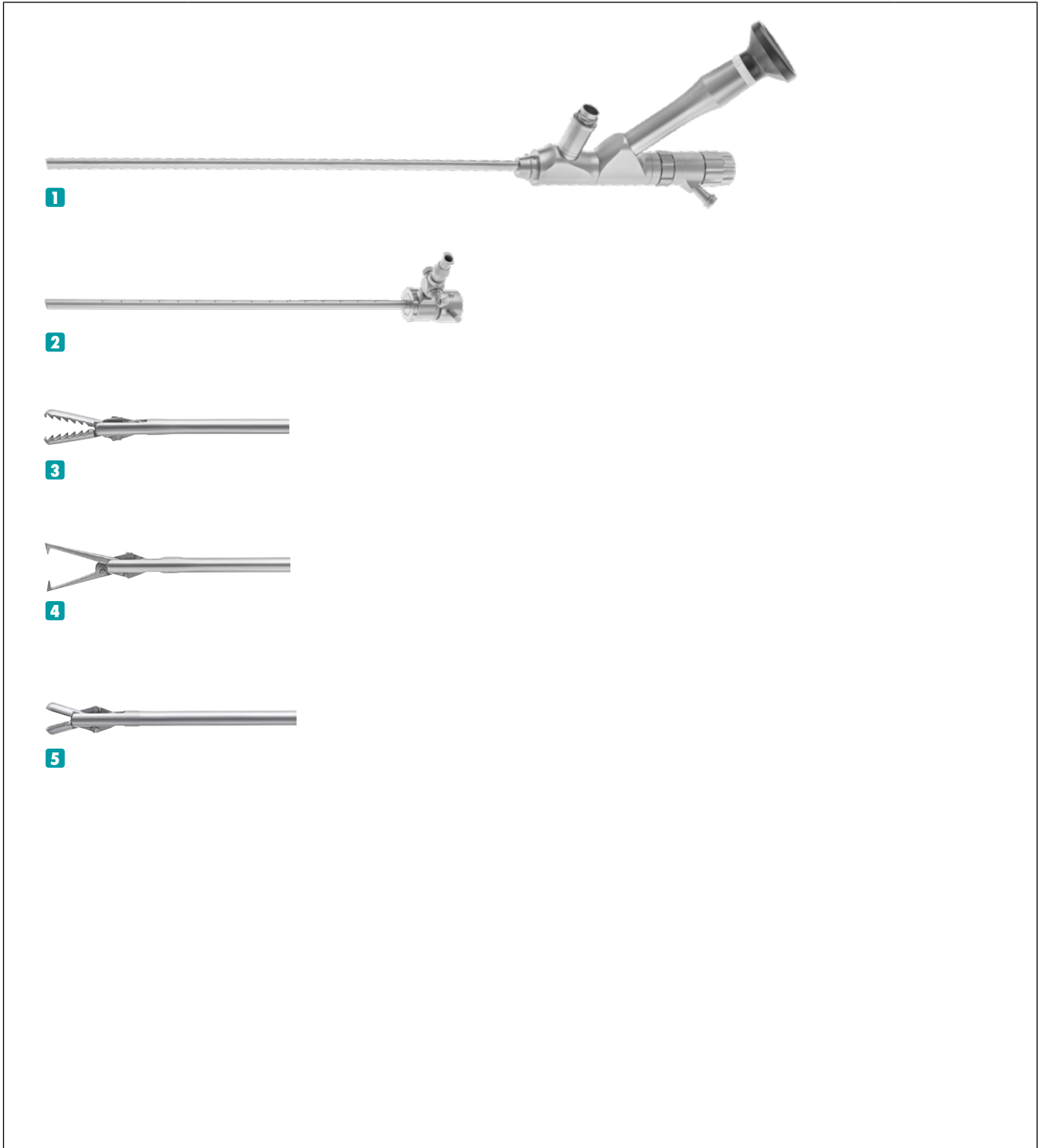

| | Article-No. | Description | Page | Qty. |
|----------|-------------|---|------|-------|
| 1 | 253-900-630 | Compact Nephroscope | 91 | 1 pc. |
| 2 | 253-900-666 | Shaft with Obturator | 91 | 1 pc. |
| 3 | 253-950-455 | Stone Grasping forceps | 89 | 1 pc. |
| 4 | 253-952-455 | Stone Grasping Forceps for large stones | 89 | 1 pc. |
| 5 | 253-956-455 | Biopsy Forceps | 89 | 1 pc. |

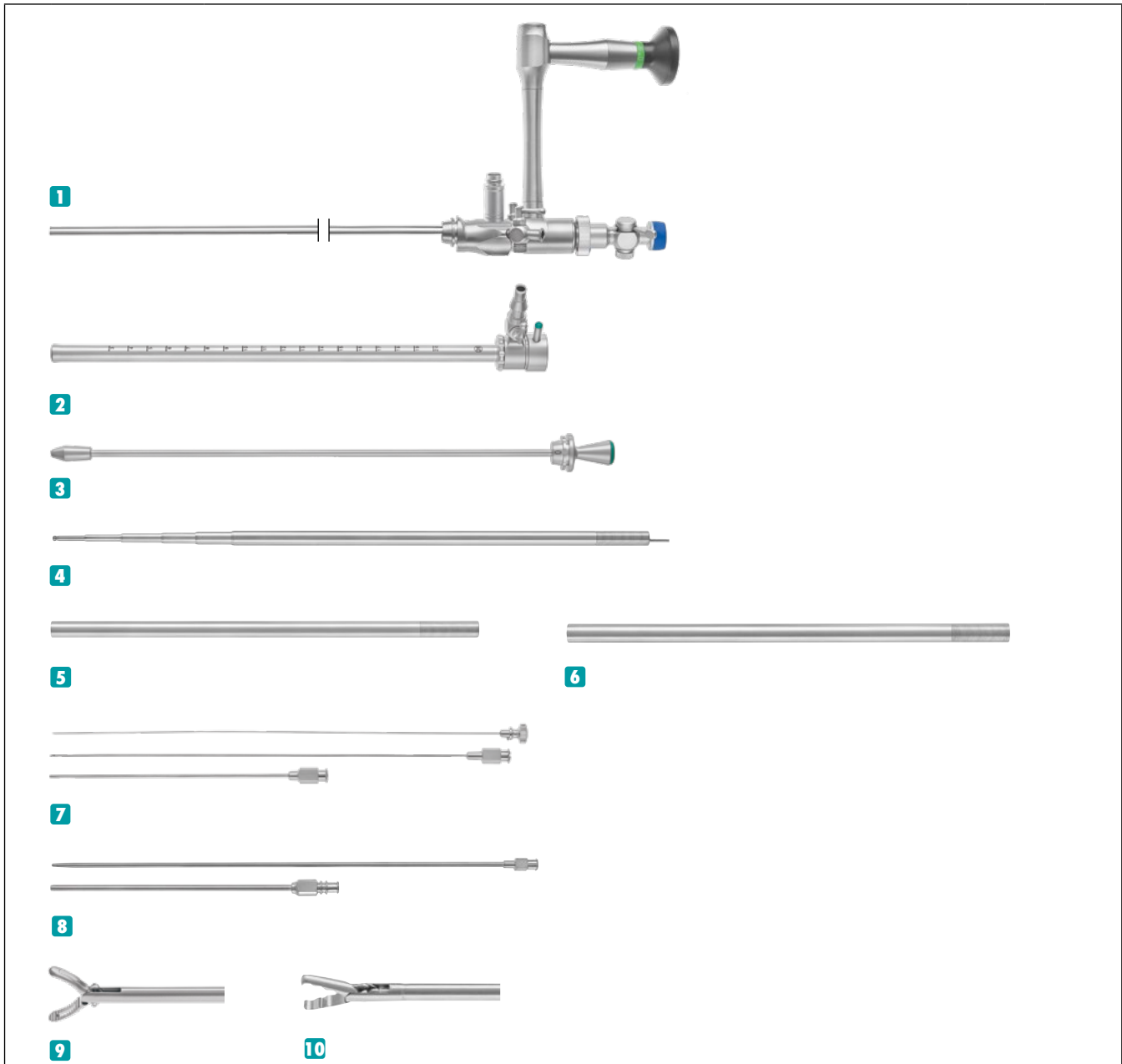

| | Article-No. | Description | Page | Qty. |
|-----------|-------------|---|------|-------|
| 1 | 253-900-121 | Nephroscope, 6° direction of view | 93 | 1 pc. |
| 2 | 253-900-130 | Operating Sheath 26 Charr. | 93 | 1 pc. |
| 3 | 253-900-135 | Hollow Obturator 26 Charr. | 93 | 1 pc. |
| 4 | 253-900-155 | Amplatz metal Dilator Set | 94 | 1 pc. |
| 5 | 253-900-156 | Amplatz metal Dilator 27 Charr. | 94 | 1 pc. |
| 6 | 253-900-157 | Amplatz metal Dilator 30 Charr. | 94 | 1 pc. |
| 7 | 253-900-201 | Puncture Cannula with inner and outer cannula | 94 | 1 pc. |
| 8 | 253-900-202 | Dilation Cannula, \varnothing 3mm | 94 | 1 pc. |
| 9 | 253-900-250 | Stone Grasping Forceps, fenestrated | 96 | 1 pc. |
| 10 | 253-900-252 | Stone Grasping Forceps, coarse serrated | 96 | 1 pc. |

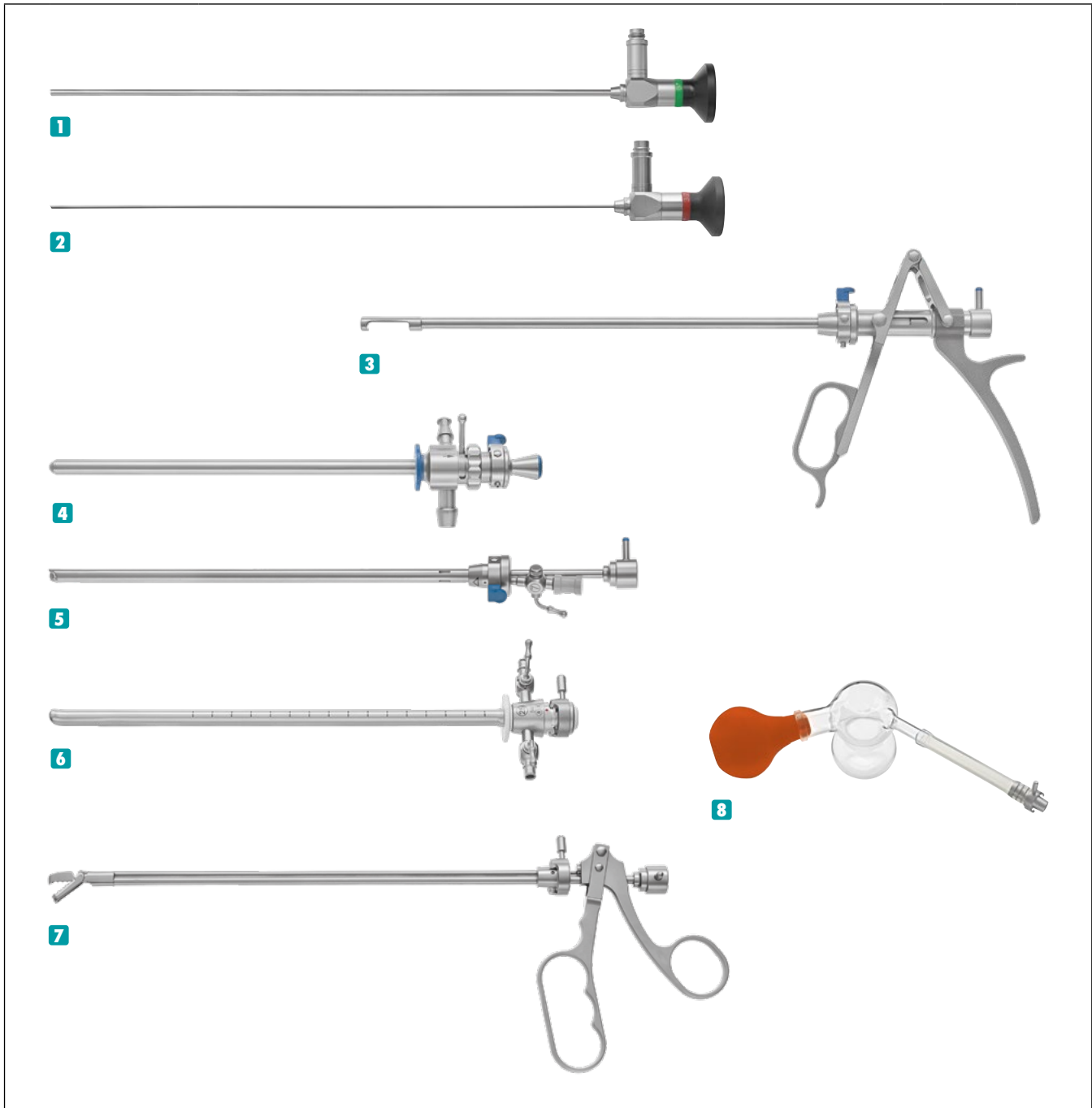

| | Article-No. | Description | Page | Qty. |
|----------|-------------|--|------|-------|
| 1 | 253-804-000 | RZ Cystoscope 4.0mm Ø, 0° direction of view | 19 | 1 pc. |
| 2 | 253-804-030 | RZ Cystoscope 4.0mm Ø, 30° direction of view | 19 | 1 pc. |
| 3 | 253-755-010 | Mauermayer Stone Punch | 67 | 1 pc. |
| 4 | 253-755-020 | Punch Sheath with Central Valve, 24 Charr. | 67 | 1 pc. |
| 5 | 253-755-030 | Visual Obturator with 7 Charr. working channel | 67 | 1 pc. |
| 6 | 253-300-025 | Cysto-Urethroscope Sheath 25 Charr. | 20 | 1 pc. |
| 7 | 253-760-000 | Stone Crushing Forceps for small stones, single action | 69 | 1 pc. |
| 8 | 253-500-000 | Elik Evacuator with turn lock connection | 106 | 1 pc. |

Lithotripsy Set, electro-pneumatic

253-900-926

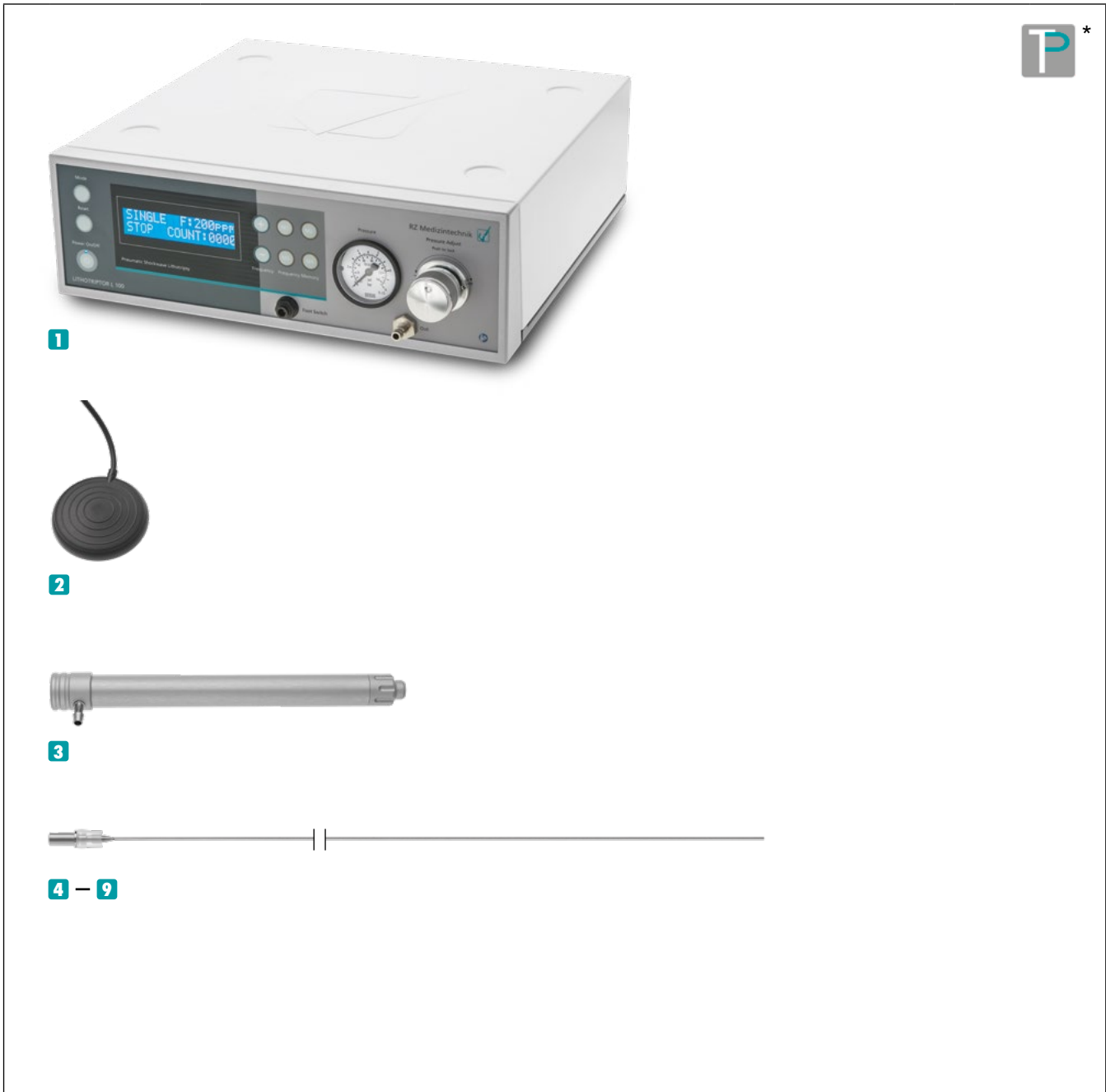

| | Article-No. | Description | Page | Qty. |
|----------|-------------|-----------------------|------|--------|
| 1 | 253-750-100 | L 100 Lithotripter | 126 | 1 pc. |
| 2 | 253-750-150 | Pneumatic Footswitch | | 1 pc. |
| 3 | 253-750-200 | Hand piece, annodised | | 1 pc. |
| 4 | 253-850-006 | Litho Probe, 0.6mm | | 2 pcs. |
| 5 | 253-850-008 | Litho Probe, 0.8mm | | 2 pcs. |
| 6 | 253-850-010 | Litho Probe, 1.0mm | | 2 pcs. |
| 7 | 253-850-012 | Litho Probe, 1.2mm | | 2 pcs. |
| 8 | 253-850-016 | Litho Probe, 1.6mm | | 2 pcs. |
| 9 | 253-850-020 | Litho Probe, 2.0mm | | 2 pcs. |

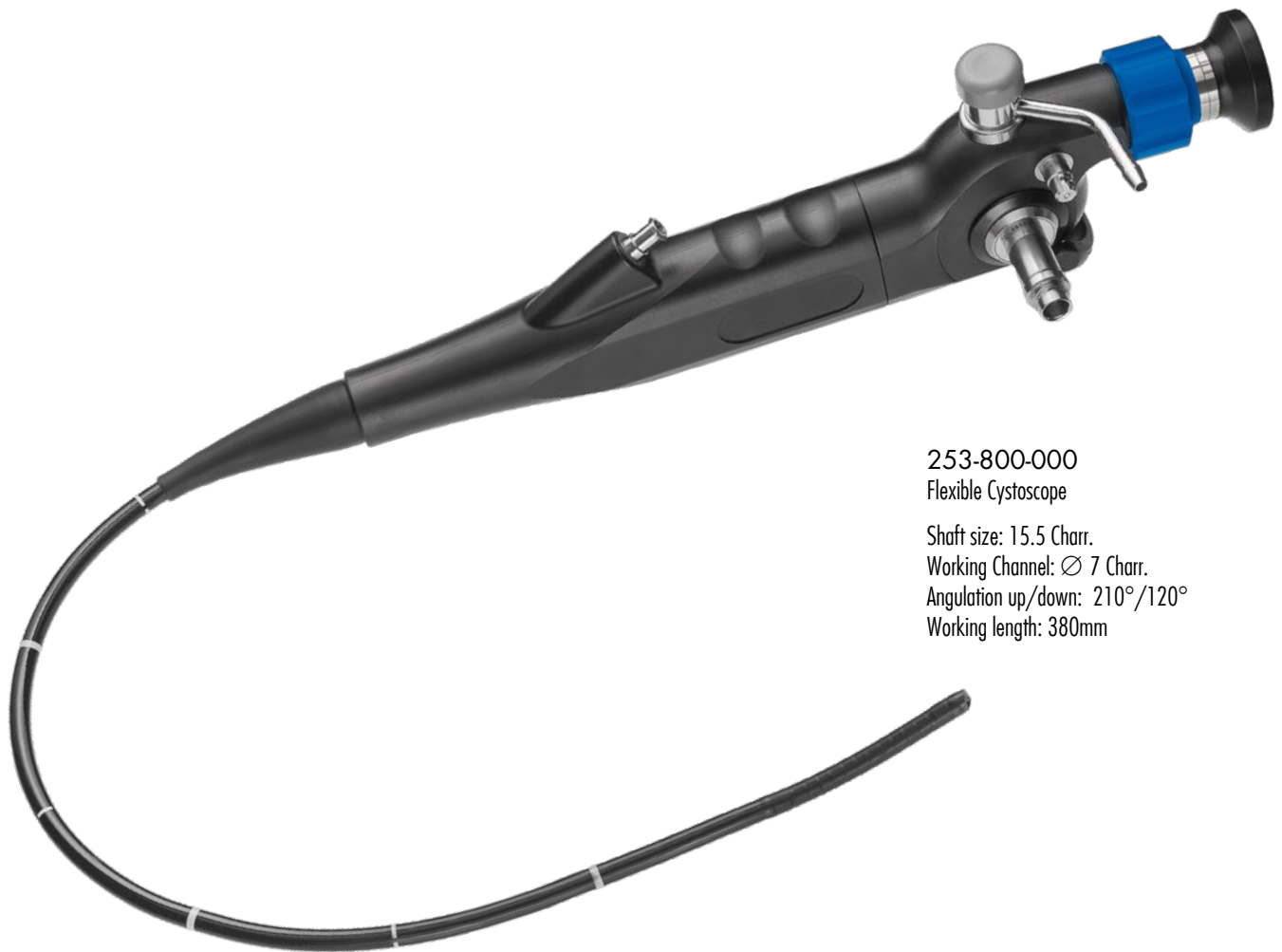

253-800-000

Flexible Cystoscope

Shaft size: 15.5 Charr.

Working Channel: \varnothing 7 Charr.

Angulation up/down: 210°/120°

Working length: 380mm



Shaft size: 15.5 Charr.
Slimline Sheath for
easy insertion



Angulation: 210°/120°



7 Charr. working
channel



Universal suction system

- Colour coded rings identify the „direction of view“
- Eyepiece for C-mount connection
- 3-step light post adapters to connect the most common light cables directly to the endoscope
- Sapphire glasses ensure highest stability against damages on the lens system
- Optimized glass fibre arrangements ensure an uniform image brightness of highest quality
- High definition pictures with increased detail-resolution through newest CAD-designed rod-lens systems
- Fully Autoclavable at 134°C and 2.3bar

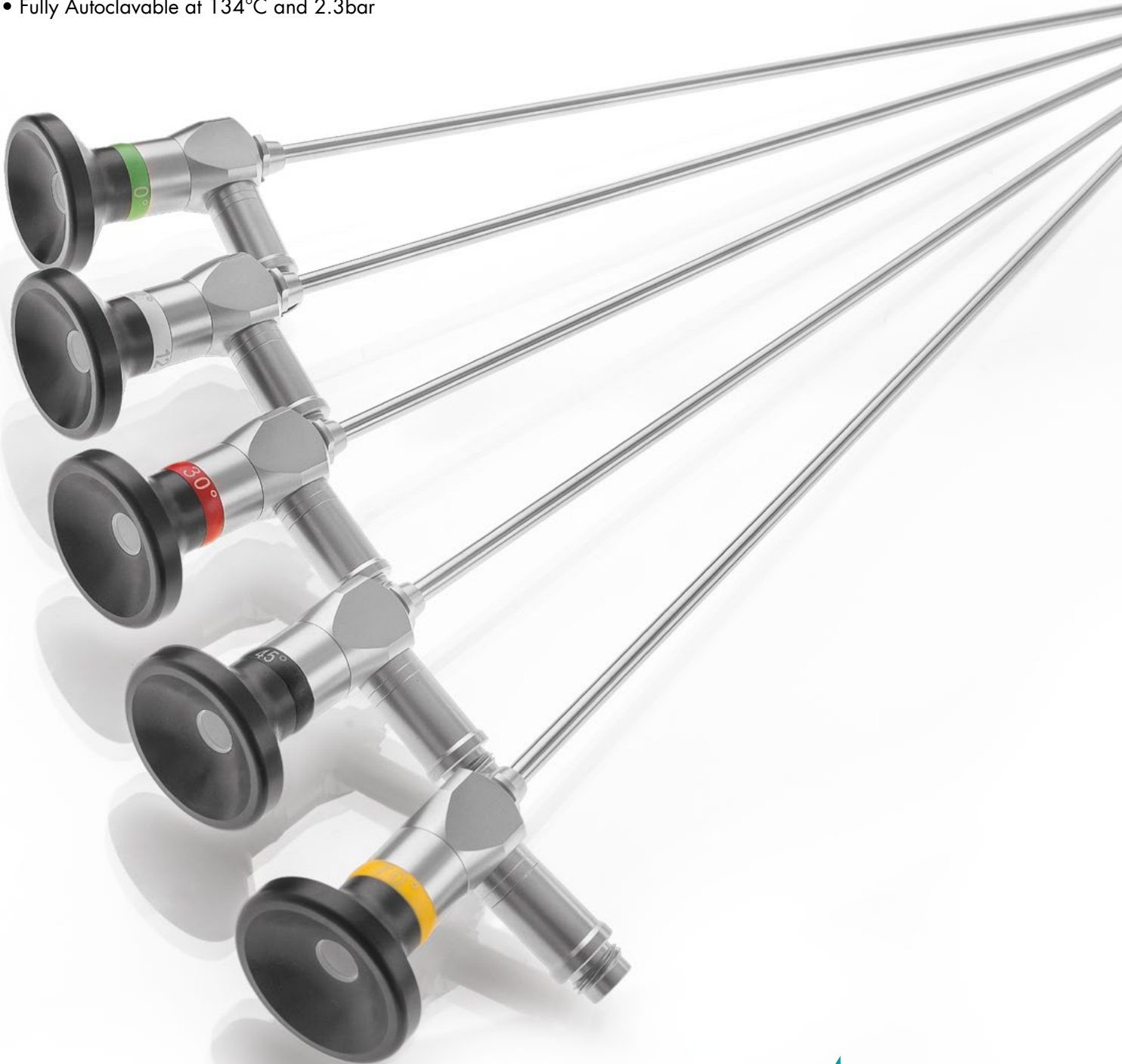

● ○ ● ●
 0° 12° 30° 70°

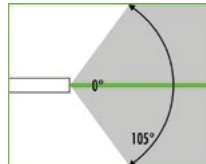
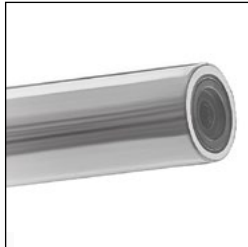

253-804-000★ RZ Cystoscope 4.0mm Ø, 0° direction of view

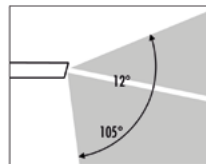

253-804-012★ RZ Cystoscope 4.0mm Ø, 12° direction of view

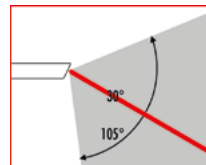
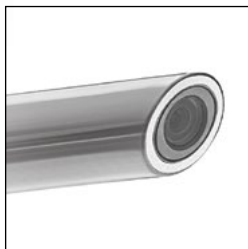

253-804-030★ RZ Cystoscope 4.0mm Ø, 30° direction of view

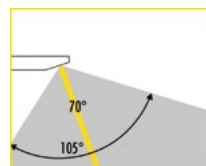

253-804-070★ RZ Cystoscope 4.0mm Ø, 70° direction of view

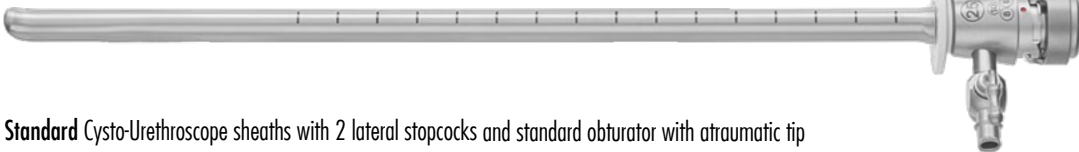

Standard Cysto-Urethroscope sheaths with 2 lateral stopcocks and standard obturator with atraumatic tip

- 253-300-017★ Cysto-Urethroscope Sheath 17 Charr. ●
- 253-300-019★ Cysto-Urethroscope Sheath 19 Charr. ●
- 253-300-020★ Cysto-Urethroscope Sheath 20 Charr. ●
- 253-300-022★ Cysto-Urethroscope Sheath 22 Charr. ●
- 253-300-025★ Cysto-Urethroscope Sheath 25 Charr. ○



Long Window Cysto-Urethroscope sheaths with 2 lateral stopcocks and standard obturator with atraumatic tip

- 253-300-119 Cysto-Urethroscope Sheath 19 Charr. ●
- 253-300-120 Cysto-Urethroscope Sheath 20 Charr. ●
- 253-300-122 Cysto-Urethroscope Sheath 22 Charr. ●
- 253-300-125 Cysto-Urethroscope Sheath 25 Charr. ○



Central Valve Cysto-Urethroscope sheaths with 2 stopcocks and central valve
Sheaths with standard obturator and atraumatic tip

- 253-310-017 Cysto-Urethroscope Sheath 17 Charr. ●
- 253-310-019 Cysto-Urethroscope Sheath 19 Charr. ●
- 253-310-020 Cysto-Urethroscope Sheath 20 Charr. ●
- 253-310-022 Cysto-Urethroscope Sheath 22 Charr. ●
- 253-310-025 Cysto-Urethroscope Sheath 25 Charr. ○

Central valve for easy regulation of suction and irrigation





Standard Obturators with atraumatic tip and locking mechanism to fit all RZ Cysto-Urethroscope sheaths

- 253-000-117 Obturator 17 Charr. ●
- 253-000-119 Obturator 19 Charr. ●
- 253-000-120 Obturator 21 Charr. ●
- 253-000-122 Obturator 23 Charr. ●
- 253-000-125 Obturator 25 Charr. ○



Visual Obturators with telescope locking mechanism to fit all 4mm RZ cystoscopes to insert the Cysto-Urethroscope sheaths under vision

- 253-000-217 Obturator 17 Charr. ●
- 253-000-219 Obturator 19 Charr. ●
- 253-000-220 Obturator 20 Charr. ●
- 253-000-222 Obturator 22 Charr. ●
- 253-000-225 Obturator 25 Charr. ○



253-315-000
Hamada Cystoscope Adapter for use with RZ Cystoscope Sheath on the female urethra

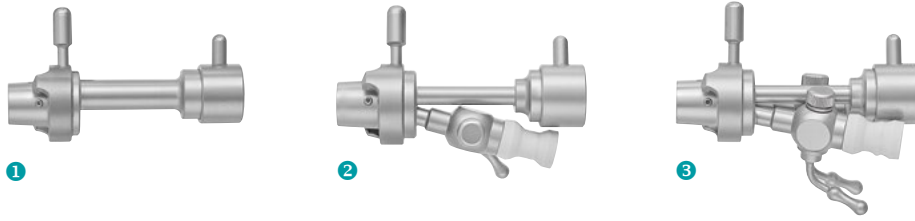

Cystoscope Bridge for all RZ Cysto-Urethroscope sheaths. Main feature: flat insertion angle for use of semi-rigid instruments and lithotripter probes.

- ❶ 253-000-100★ Bridge without channel
- ❷ 253-000-101★ Bridge with 1 channel for 1 instrument with max. 12 Charr.
- ❸ 253-000-102★ Bridge with 2 channels for 1 instrument with max. 12 Charr. or 2 instruments with max. 8 Charr.

Albarran deflecting mechanism for use with 19-25 Charr. RZ Cysto-Urethroscope sheaths. The ratchet mechanism will keep the deflecting mechanism in place for easy handling during surgery.

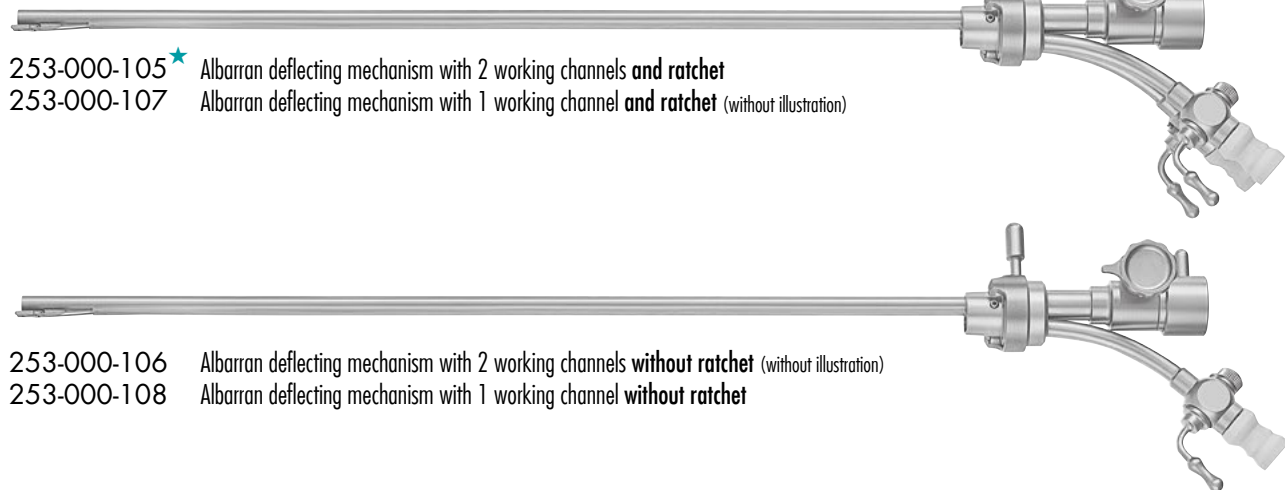

- 253-000-105★ Albarran deflecting mechanism with 2 working channels **and ratchet**
- 253-000-107 Albarran deflecting mechanism with 1 working channel **and ratchet** (without illustration)



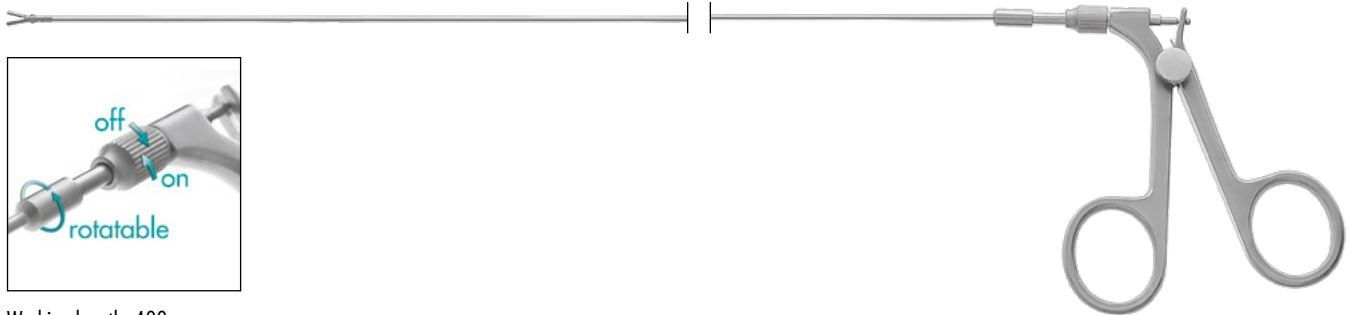

- 253-000-106 Albarran deflecting mechanism with 2 working channels **without ratchet** (without illustration)
- 253-000-108 Albarran deflecting mechanism with 1 working channel **without ratchet**

Spread sheet for Sheath - Instrument combinations

| Cysto-Urethroscope Sheath | Colour | with Albarran | with bridge |
|---------------------------|--------|-------------------------------|-------------------------------|
| 25 Charr. | ○ | 1 x 10 Charr. 2 x 8 Charr. | 1 x 12 Charr. 2 x 8 Charr. |
| 22 Charr. | ● | 1 x 9 Charr. 2 x 6 Charr. | 1 x 10 Charr. 2 x 7 Charr. |
| 20 Charr | ● | 1 x 6 Charr 2 x 5 Charr. | 1 x 7 Charr. 2 x 6 Charr. |
| 19 Charr | ● | 1 x 5 Charr 2 x 4 Charr. | 1 x 6 Charr. 2 x 5 Charr. |
| 17 Charr | ● | - | 1 x 5 Charr. |



Working length: 400mm
Rotatable and detachable for optimum setup during surgery.

| | Flexible | Semi rigid |
|--|-----------------------------------|----------------------|
|  Grasping Forceps, serrated jaws, double action | 351-114-105 [★] 5 Charr. | 351-114-305 5 Charr. |
| | 351-114-107 [★] 7 Charr. | 351-114-307 7 Charr. |
| | 351-114-109 9 Charr. | |
|  Biopsy Forceps, oval cup, double action | 351-120-105 [★] 5 Charr. | 351-120-305 5 Charr. |
| | 351-120-107 [★] 7 Charr. | 351-120-307 7 Charr. |
| | 351-120-109 9 Charr. | |
|  Serrated Biopsy Forceps 7 Charr., oval cup with aggressive serration, double action | 351-124-107 7 Charr. | 351-124-307 7 Charr. |
|  Scissors, single action | 351-100-105 [★] 5 Charr. | 351-100-305 5 Charr. |
| | 351-100-107 7 Charr. | 351-100-307 7 Charr. |
| | 351-100-109 9 Charr. | |
|  DJ Forceps, double action | 351-107-107 7 Charr. | 351-107-307 7 Charr. |
| | 351-107-109 9 Charr. | |

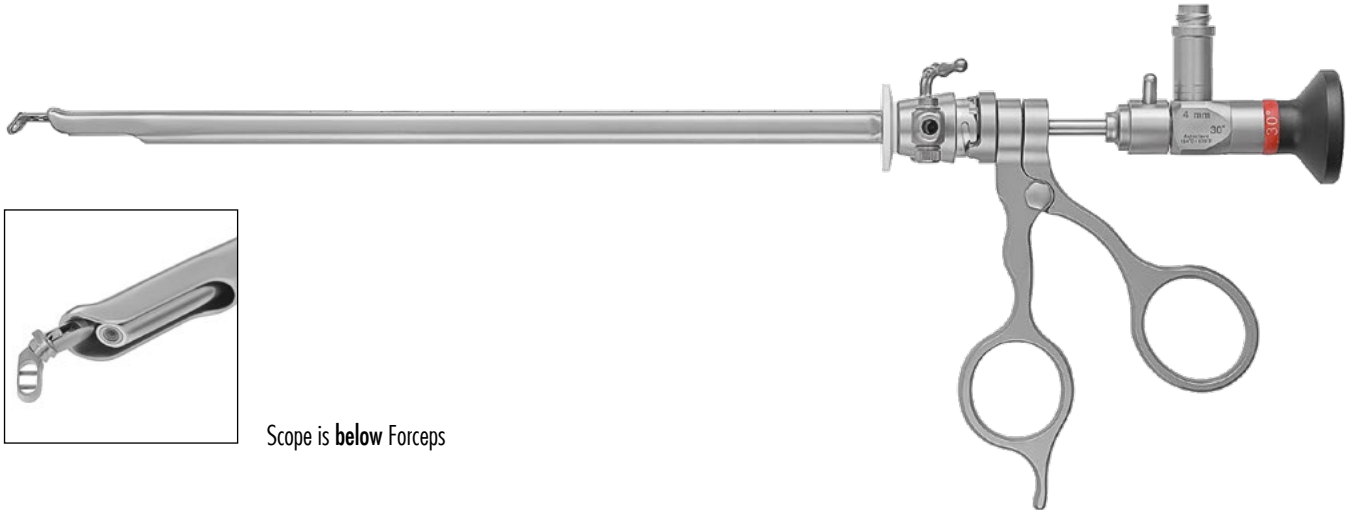

Scope is **below** Forceps



253-420-100★ Spoon Biopsy Forceps with round cup, double action



253-421-100 Grasping Forceps with serrated jaws, double action



253-422-100 Biopsy Punch Forceps, thru-cutting, double action



253-423-100 Scissors, hook type blades, double action



Scope is **above** Forceps

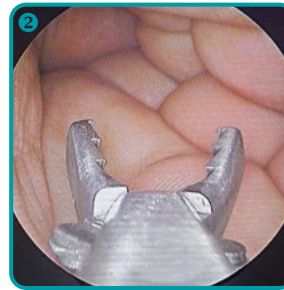
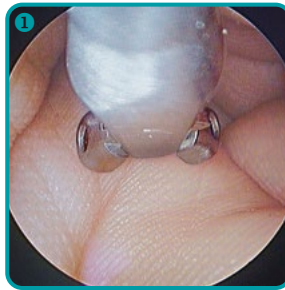

Comparison: field of view
 ① Scope is **below** Forceps
 ② Scope is **above** Forceps

Original picture with
 0° RZ Cystoscope



253-426-100★ Mini Biopsy forceps with oval cup, double action for use with 4mm, 30° cystoscope



253-431-100★ Biopsy forceps with large oval cup, double action for use with 4mm, 30° cystoscope



253-425-100 Biopsy forceps with mini oval cup, double action for use with 4mm, 70° cystoscope



253-427-100★ Stent Grasping forceps with serrated jaws, double action jaws for removal of stents



253-429-100★ Adapter for use of optical forceps with resectoscope sheaths

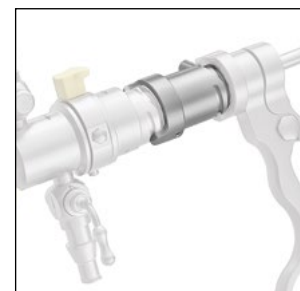

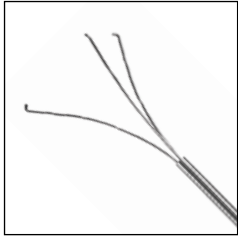

253-940-005
3-Prongs Grasper, flexible, 600mm working length, 5 Charr.

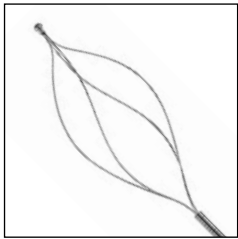

253-585-005
Dormia Metal Stone Basket, flexible, 4 wires, 600mm working length, 5 Charr.

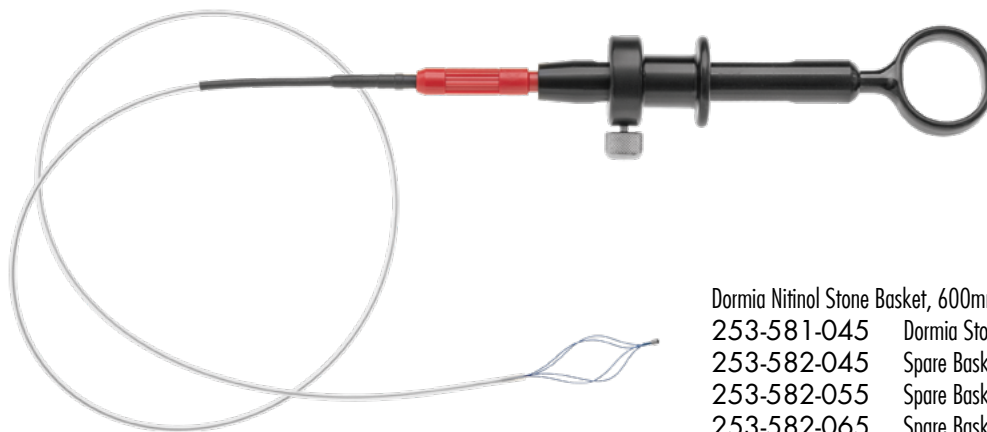

Dormia Nitinol Stone Basket, 600mm working length, 5 Charr.,
253-581-045 Dormia Stone Basket with 4 wires, complete with handle
253-582-045 Spare Basket only, 4 wires
253-582-055 Spare Basket only, 5 wires
253-582-065 Spare Basket only, 6 wires

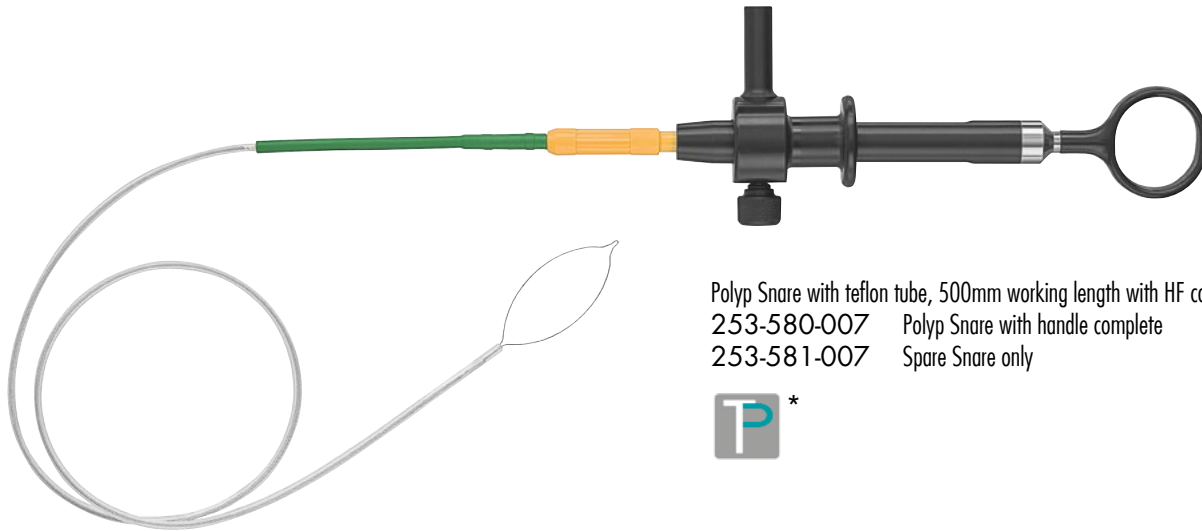

Polyp Snare with teflon tube, 500mm working length with HF connection, 7 Charr.
 253-580-007 Polyp Snare with handle complete
 253-581-007 Spare Snare only

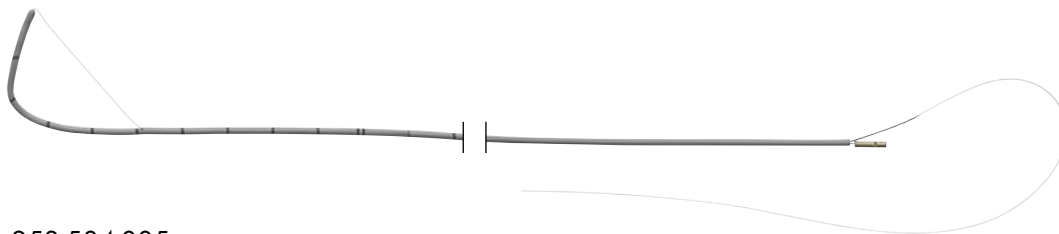

253-584-005
 Zeiss Loop Catheter, package with 5 pieces, sterile, single use, 5 Charr.



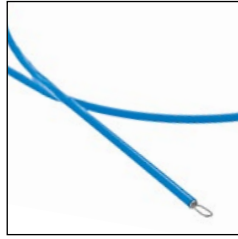
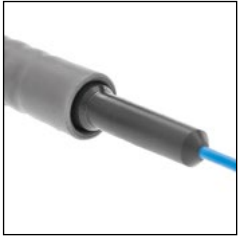

Ball Electrode 530mm working length

 253-370-003 3 Charr.

 253-370-007 7 Charr.

 253-370-005[★] 5 Charr.

 253-370-010 10 Charr.



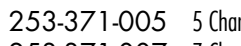
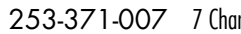

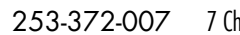
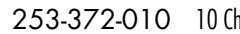

Needle Electrode 530mm working length

 253-371-003 3 Charr.
 253-371-005 5 Charr.
 253-371-007 7 Charr.

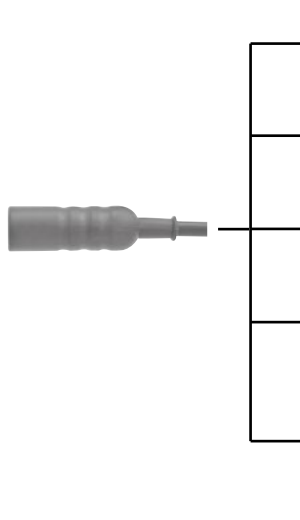
Loop Electrode 530mm working length

 253-372-005 5 Charr.
 253-372-007 7 Charr.
 253-372-010 10 Charr.

Monopolar High Frequency cables for use with RZ Urology Electrodes, 4.5m length

| | | |
|--|---|---|
|  |  | 253-610-001 [★] with 5 mm plug for Erbe HF-unit |
| |  | 253-610-002 [★] with 4 mm plug for Martin HF-unit |
| |  | 253-610-003 [★] with 8 mm plug for Valleylab HF-unit |
| |  | 253-610-004 [★] with 4 mm plug for older HF-units |
| |  | 700-501-453 [★] SDS plug |

Injection Set

Set for transurethral injection of viscous liquids

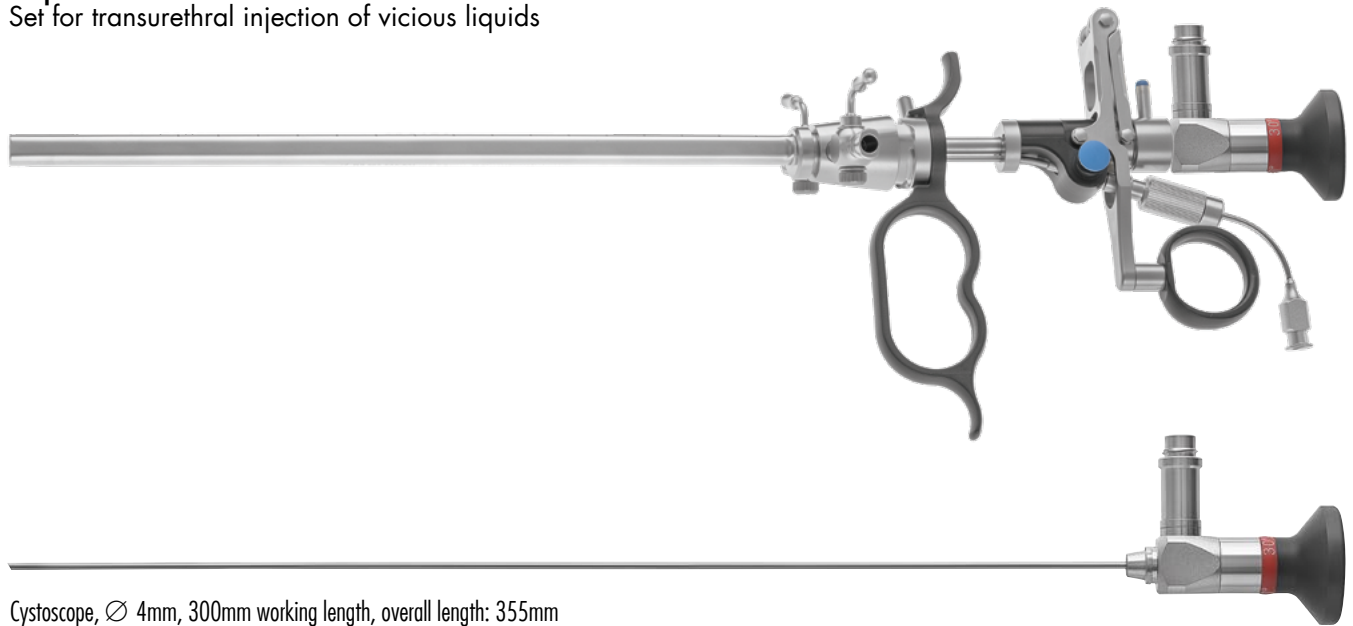

Cystoscope, Ø 4mm, 300mm working length, overall length: 355mm

253-804-030 30° direction of view

253-804-012 12° direction of view



253-000-232

Passive Titanium Working Element with channel for injection cannula 253-000-235

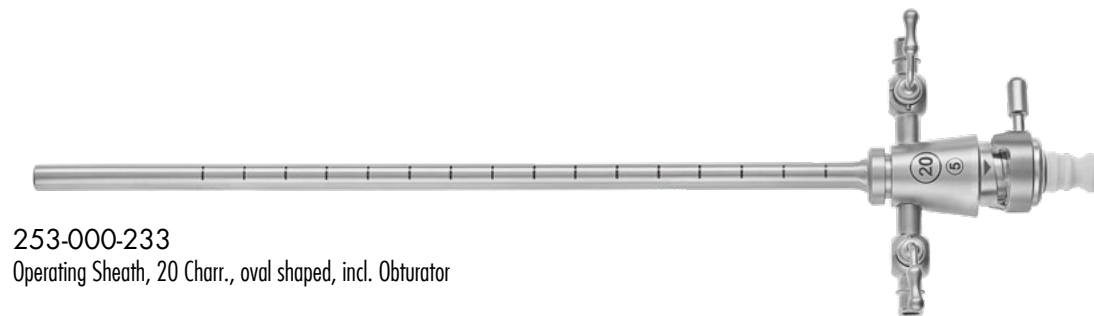

253-000-233

Operating Sheath, 20 Charr., oval shaped, incl. Obturator



253-000-235

Injection Cannula, semi-rigid, 4 Charr.

distal end 2 Charr., with rotatable Luer-Lock adapter



253-585-005
Dormia Metal Stone Basket, flexible, 4 wires, 600mm working length, 5 Charr.



253-940-005
3-Prongs Grasper, flexible, 600mm working length, 5 Charr.



253-370-103
Flexible Ball Electrode, 3 Charr., 115cm working length

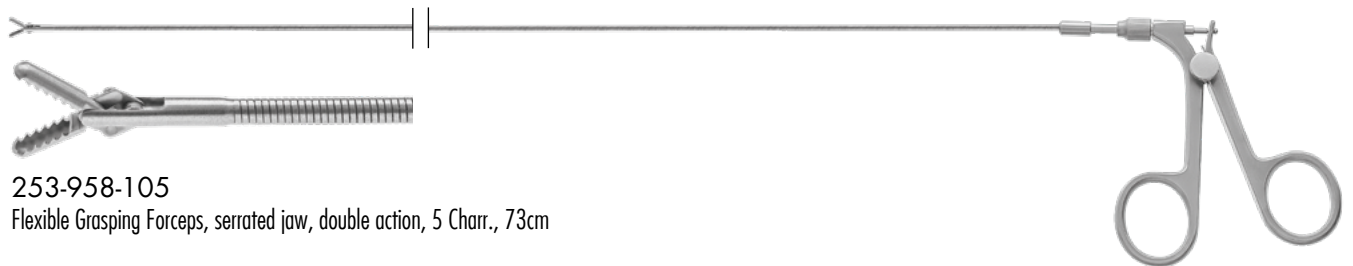

253-958-105
Flexible Grasping Forceps, serrated jaw, double action, 5 Charr., 73cm



253-957-105
Flexible Biopsy Forceps, double action, 5 Charr., 73cm



253-961-103
Cleaning Brush, flexible, 3mm diameter, 100mm length, for use in 2.0 - 2.6mm working channels



301-701-100★
Grey rubber cap for use on all working channels



300-215-000

Cleaning Brush, 13mm \varnothing , 60mm brush length, 230mm overall length

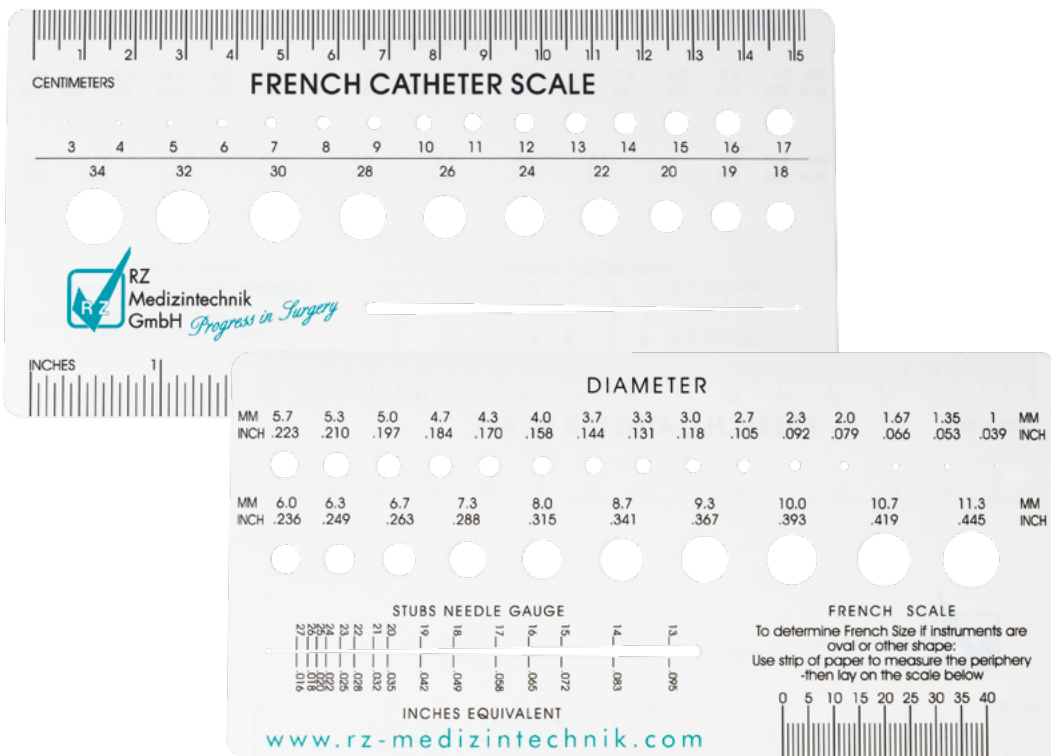

253-990-800

French Catheter Scale



MONOPOLAR

By providing the monopolar resectoscopes, RZ fulfills the traditional and most common way to perform urological resectoscopies. This technique is used with Glycine/Sorbitol irrigation fluid. Due to some disadvantages like the TUR-syndrome and the upcoming and growing use of the bipolar system, a few surgeons and clinics have to deal with various instruments for use either in

the monopolar or in the bipolar way.

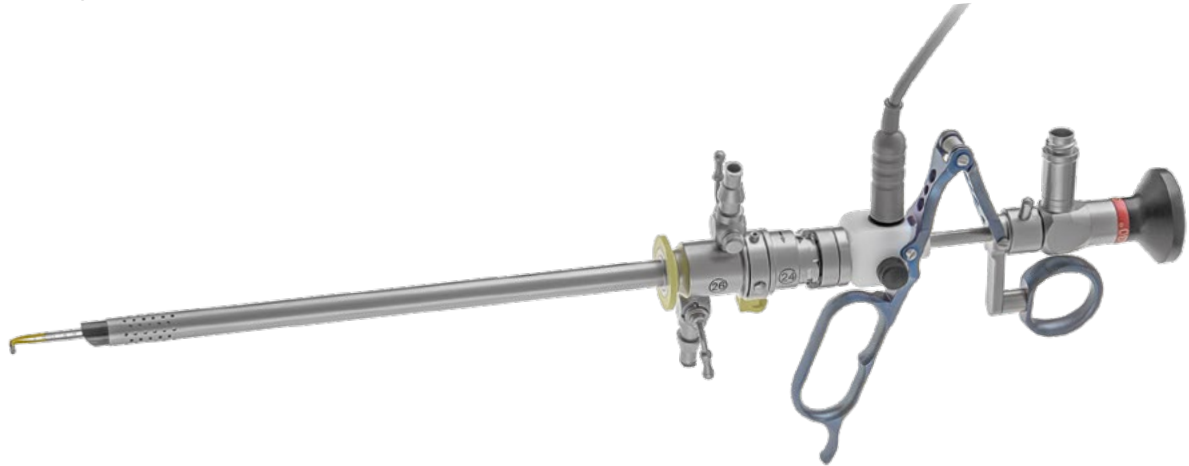

HYBRID

With the RZ HYBRID Resectoscope we present the latest and unique technology which enables to work with only one instrument set but can be used in the monopolar as well as in the bipolar way. The surgeon just needs to change the cable, the irrigation fluid

and connect the neutral electrode for changing from the bipolar to the monopolar mode. The Resectoscope as well as the electrodes can be used in an hybrid way. As irrigation fluid Glycine/Sorbitol is used in the monopolar way and NaCl-Solution in the bipolar way.

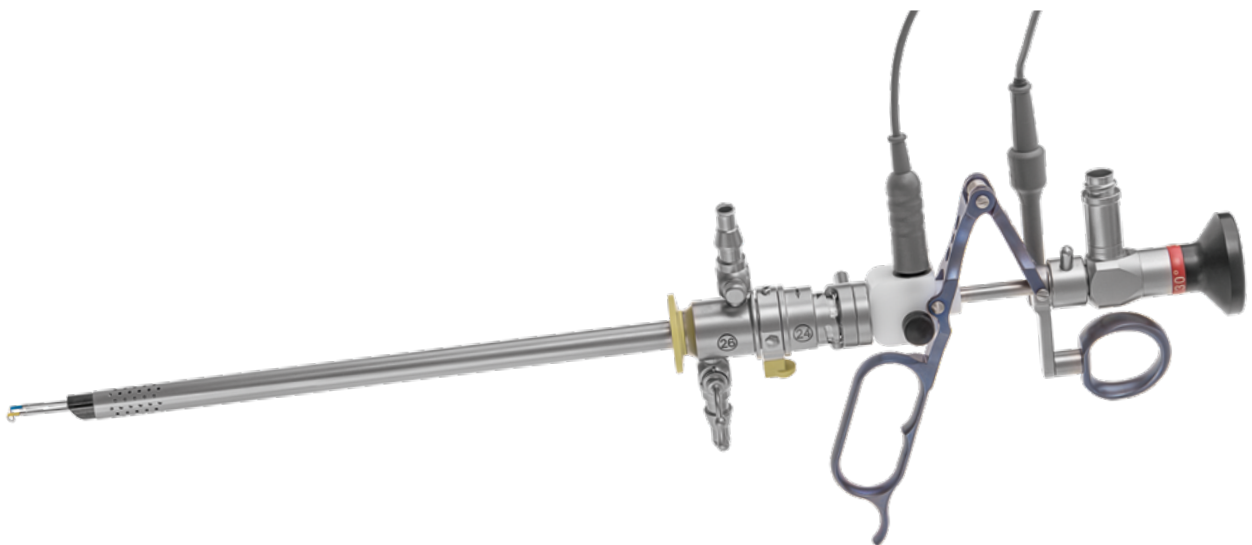

RZ MONOPOLAR working elements features

- lightweight and unique design for maximum comfort during long surgeries
- titanium handle parts
- sealed locking mechanism
- ergonomic handle design with finger rest for maximum comfort even during long surgeries
- rotating titanium thumb ring

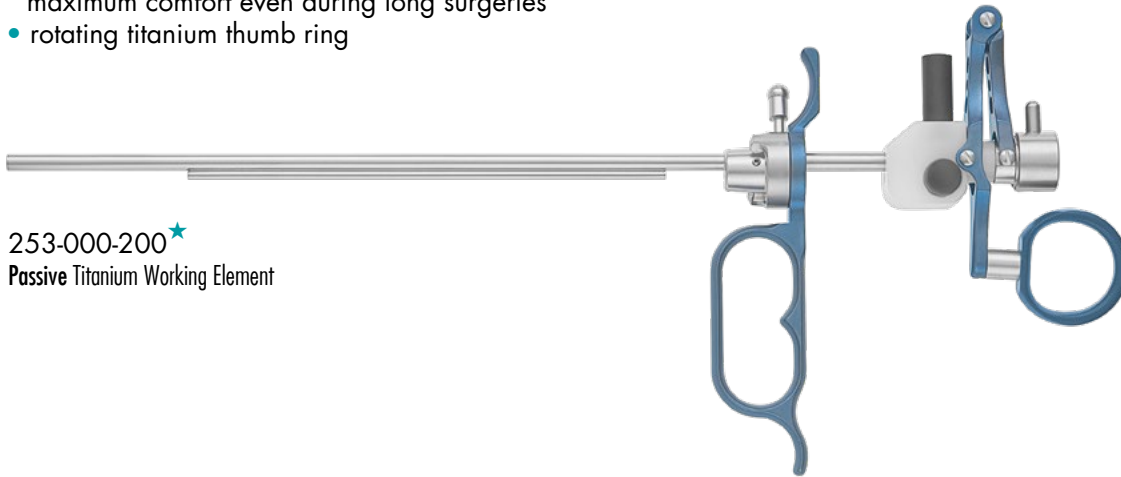

253-000-200★
Passive Titanium Working Element

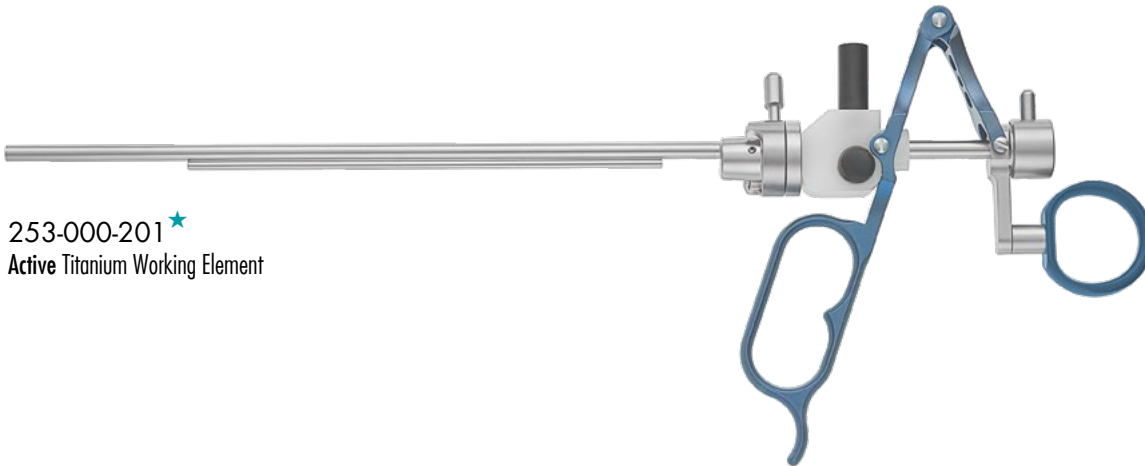

253-000-201★
Active Titanium Working Element

Monopolar High Frequency cables for use with RZ Resectoscopes, 4.5m length

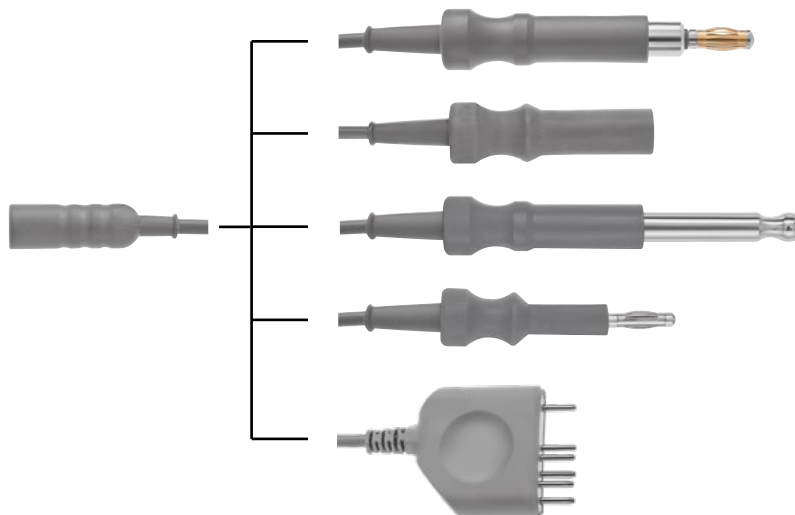

253-610-001★ with 5 mm plug for Erbe HF-unit











253-610-002★ with 4 mm plug for Martin HF-unit







253-610-003★ with 8 mm plug for Valleylab HF-unit

253-610-004★ with 4 mm plug for older HF-units

700-501-453★ SDS plug

RZ Cutting Loops are made of a standard wire diameter of \varnothing 0.35 mm.
 Different wire diameters are available on demand.
 Electrodes and Curette with 1 guide stem and stabilizer.

| | Color | 24 Charr. | 27 Charr. |
|---|-------|--------------|-------------|
|  | | 253-300-201★ | 253-300-301 |
|  | | 253-300-222 | — |
|  | | 253-300-202 | 253-300-302 |
|  | | 253-300-203★ | 253-300-303 |
|  | | 253-300-204 | — |
|  | | 253-300-205★ | 253-300-305 |
|  | | 253-300-206★ | 253-300-306 |
|  | | 253-300-207 | 253-300-307 |
|  | | 253-300-208 | 253-300-308 |
|  | | 253-300-210 | 253-300-310 |
|  | | 253-300-209 | 253-300-309 |



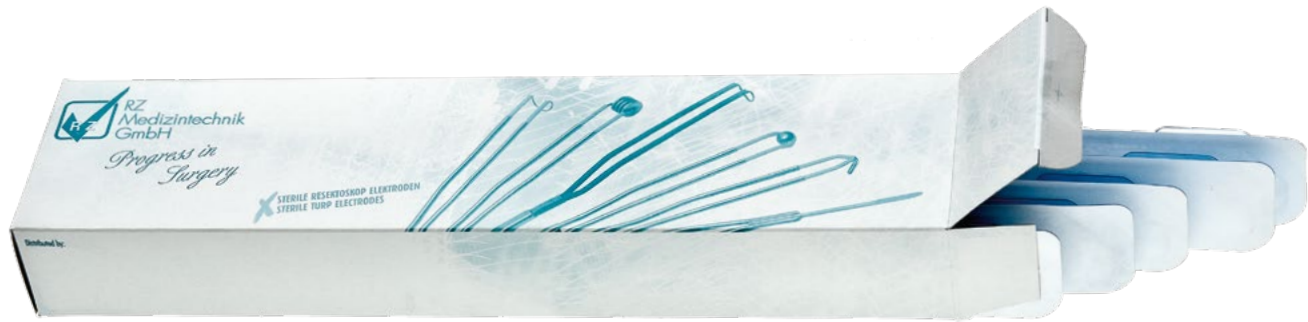

| | Colour | 24 Charr. | 27 Charr. |
|---|--------|-------------|-------------|
|  | | 253-300-212 | 253-300-312 |
|  | | 253-300-211 | 253-300-311 |
|  | | 253-300-213 | — |
|  | | 253-300-214 | — |
|  | | 253-300-215 | — |
|  | | 253-300-218 | — |
|  | | 253-300-220 | — |
| | | 253-300-219 | — |



Sterile Electrodes are ETO sterilized to eliminate infections and contaminations. Our disposables ensure the best possible working features for each operation.

Sales unit: package with 6 pieces, each individually sterile packed.

Sterile disposable TUR Electrodes fitting the RZ system. Continuous good cutting & coagulation performance.

| | Color | 24 Charr. | 27 Charr. |
|---|-------|---------------|--------------|
|  | | 253-300-201S★ | 253-300-301S |
|  | | 253-300-203S★ | 253-300-303S |
|  | | 253-300-205S★ | 253-300-305S |
|  | | 253-300-206S★ | 253-300-306S |



RZ HYBRID working elements features

- lightweight and unique design for maximum comfort during long surgeries
- titanium handle parts
- sealed locking mechanism
- ergonomic handle design with finger rest for maximum comfort even during long surgeries
- rotating titanium thumb ring

253-000-400★
HYBRID Passive Titanium Working Element

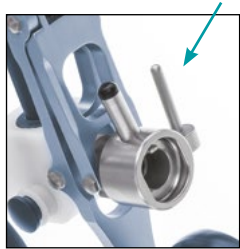





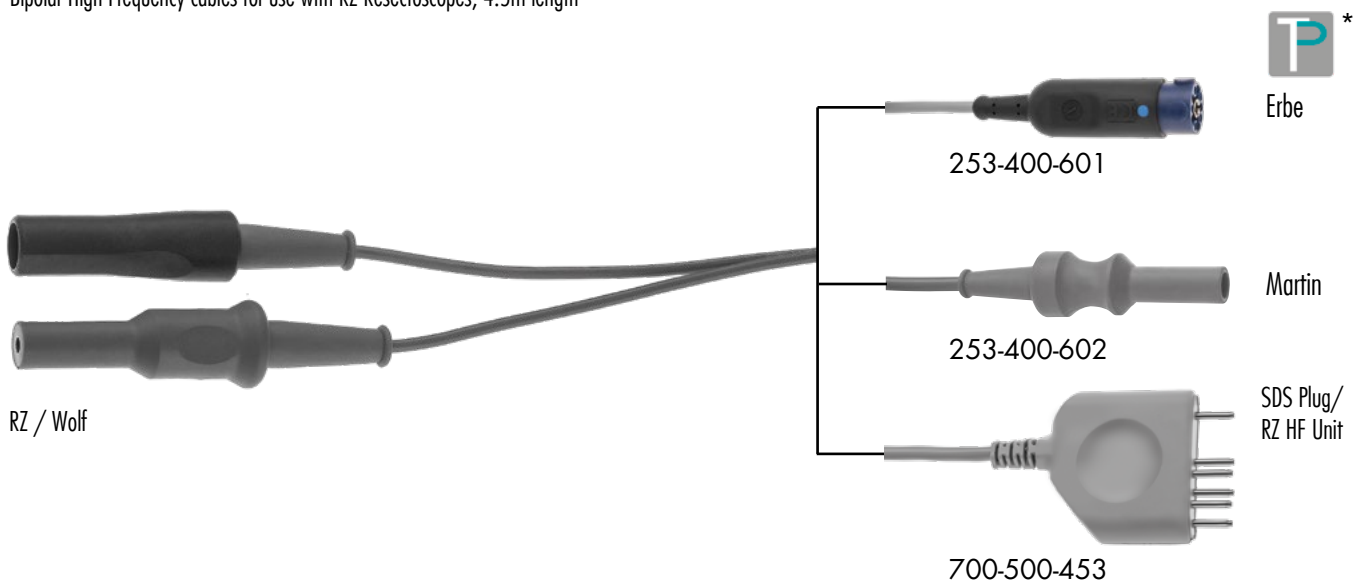



253-000-401★
HYBRID Active Titanium Working Element

Bipolar High Frequency cables for use with RZ Resectoscopes, 4.5m length







Electrodes

Designed for RZ HF units. Optimized and fitting excellent with RZ HYBRID resection.

| | Colour | 24 Charr. | 27 Charr. |
|---|--------|--------------------------|-------------|
|  | | | |
|  | | 253-400-200 | |
|  | | 253-400-201 [★] | 253-400-301 |
|  | | 253-400-202 | |
|  | | 253-400-203 [★] | |
|  | | 253-400-204 | |
|  | | 253-400-205 [★] | |
|  | | 253-400-211 | |

Mushroom Bipolar Electrodes, 24 Charr.

Electrodes create a plasma in NaCl environment and vaporize the tissue. **Attention: only for bipolar use in NaCl!**

| | | |
|---|--|-------------|
|  | blunt/flat | 253-400-701 |
|  | blunt with slot, concave | 253-400-702 |
|  | half-round (convex), Ø 3mm, length 1.9mm | 253-400-703 |
|  | half-round (convex), Ø 3mm, length 2.5mm | 253-400-704 |

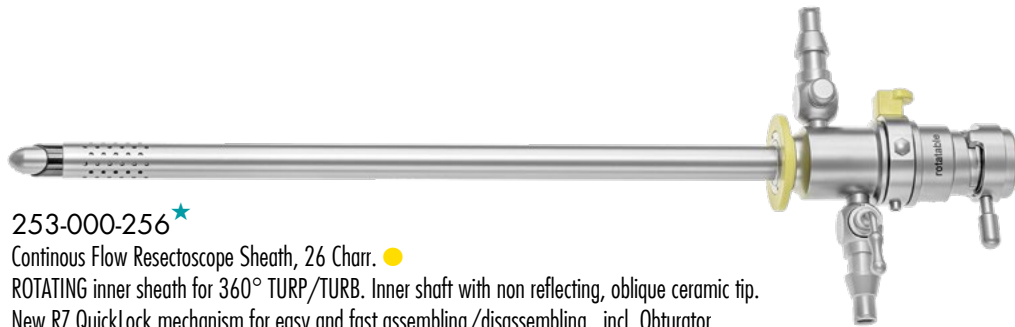

253-000-256★

Continuous Flow Resectoscope Sheath, 26 Charr. ●
 ROTATING inner sheath for 360° TURP/TURB. Inner shaft with non reflecting, oblique ceramic tip.
 New RZ QuickLock mechanism for easy and fast assembling/disassembling, incl. Obturator

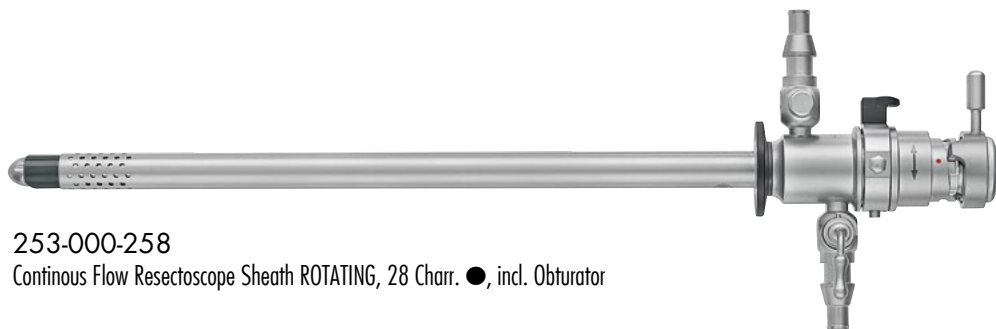
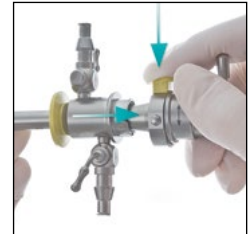

253-000-258

Continuous Flow Resectoscope Sheath ROTATING, 28 Charr. ●, incl. Obturator



253-000-266 Inner shaft, 24Charr., with oblique ceramic tip for 253-000-256 ●

253-000-268 For 253-000-258, 27 Charr. ●

„Central Valve“ Resectoscope Sheaths

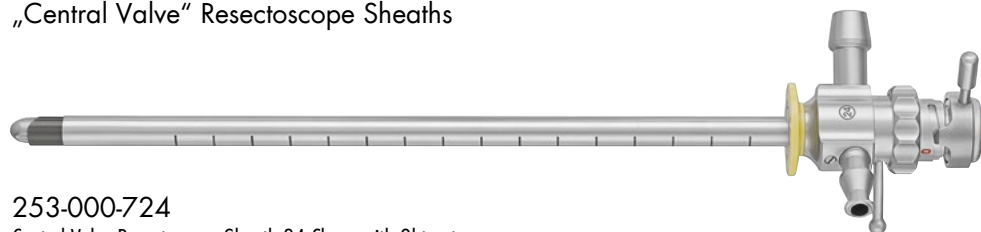

253-000-724

Central Valve Resectoscope Sheath 24 Charr, with Obturator.
 Oblique Ceramic Tip ●

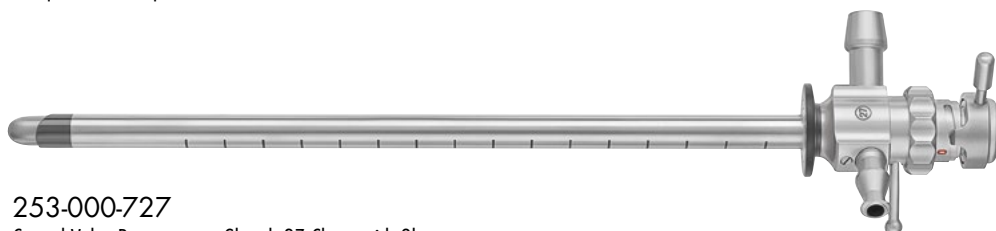

253-000-727

Central Valve Resectoscope Sheath 27 Charr, with Obturator.
 Oblique Ceramic Tip ●



253-000-356

Continuous Flow Resectoscope Sheath FIXED, 26 Charr., ● inner sheath with non reflecting, oblique ceramic tip. New RZ QuickLock mechanism for easy and fast assembling/disassembling., incl. Obturator

253-000-358

Continuous Flow Resectoscope Sheath FIXED, 28 Charr. ●, incl. Obturator



253-000-366 Inner shaft with oblique ceramic tip for 253-000-356 ●
253-000-368 For 253-000-358 ●



253-000-524

Resectoscope Sheath 24 Charr. with Obturator.
Oblique Ceramic Tip ●



253-000-527

Resectoscope Sheath 27 Charr. with Obturator.
Oblique Ceramic Tip ●



253-428-500

Adapter for Resectoscope Outer sheaths 253-000-256 and -356 and Ellik or bladder syringes



Standard Obturator

253-000-044★ For 24/26 Charr. Resectoscope Sheaths
 253-000-047 For 27/28 Charr. Resectoscope Sheaths

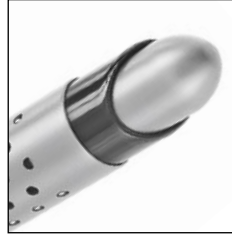

Deflecting Obturator

253-000-054★ For 24/26 Charr. Resectoscope Sheaths
 253-000-057 For 27/28 Charr. Resectoscope Sheaths



Visual Obturator for 4mm RZ Cystoscopes

253-000-084★ For 24/26 Charr. Resectoscope Sheaths
 253-000-087 For 27/28 Charr. Resectoscope Sheaths



Visual Obturator with 5 Charr. working channel, for 4mm RZ Cystoscopes

253-000-094★ For 24/26 Charr. Resectoscope Sheaths
 253-000-097 For 27/28 Charr. Resectoscope Sheaths



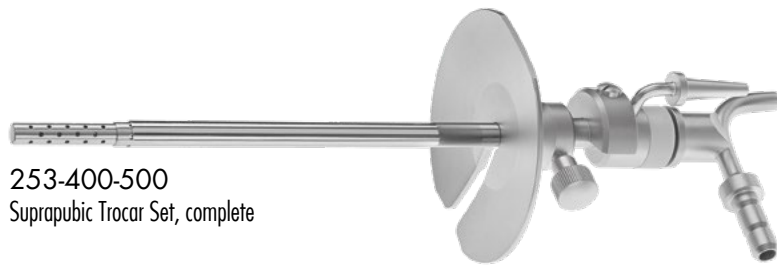

253-400-500
Suprapubic Trocar Set, complete



253-400-501
Trocar sheath, 16 Charr., with pressure channel
with spare silicone sealings



253-400-503
Suprapubic Trocar with pyramidal tip



253-400-504
Suprapubic Trocar with cannula tip



253-400-505
Aspiration Cannula



253-400-506
Overflow Cannula



253-400-508
Trocar guide sheath, lateral open

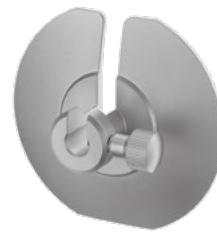

253-400-502
Suprapubic Trocar Stabilizing Plate, lateral open

HYBRID
HYBRID

26 Charr.



◀ 245mm working length ▶



253-804-530
XL Cystoscope, Ø 4mm, 30° direction of view,
365mm length

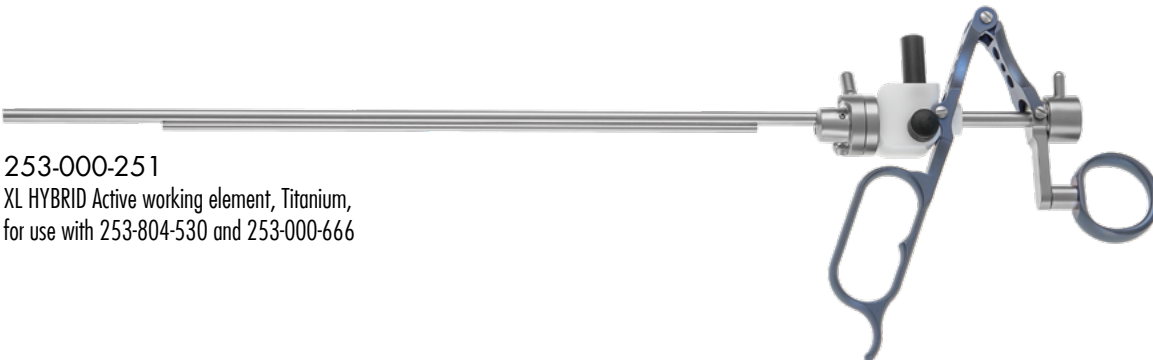

253-000-251
XL HYBRID Active working element, Titanium,
for use with 253-804-530 and 253-000-666

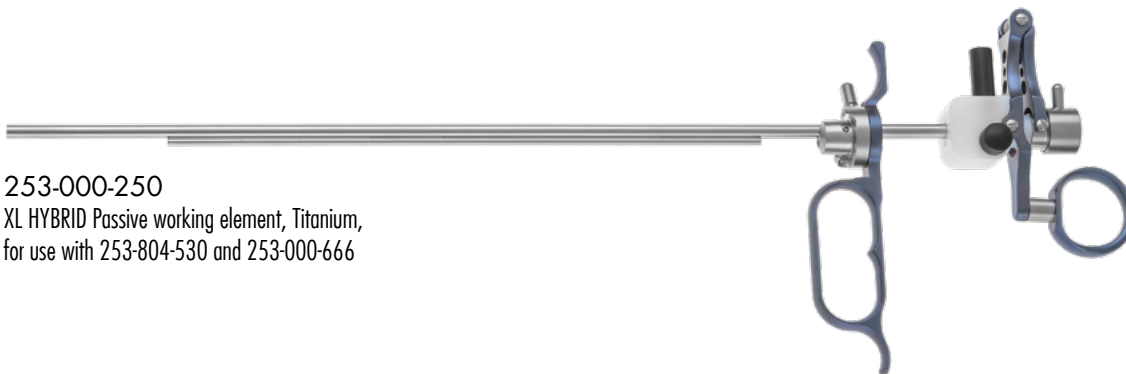

253-000-250
XL HYBRID Passive working element, Titanium,
for use with 253-804-530 and 253-000-666

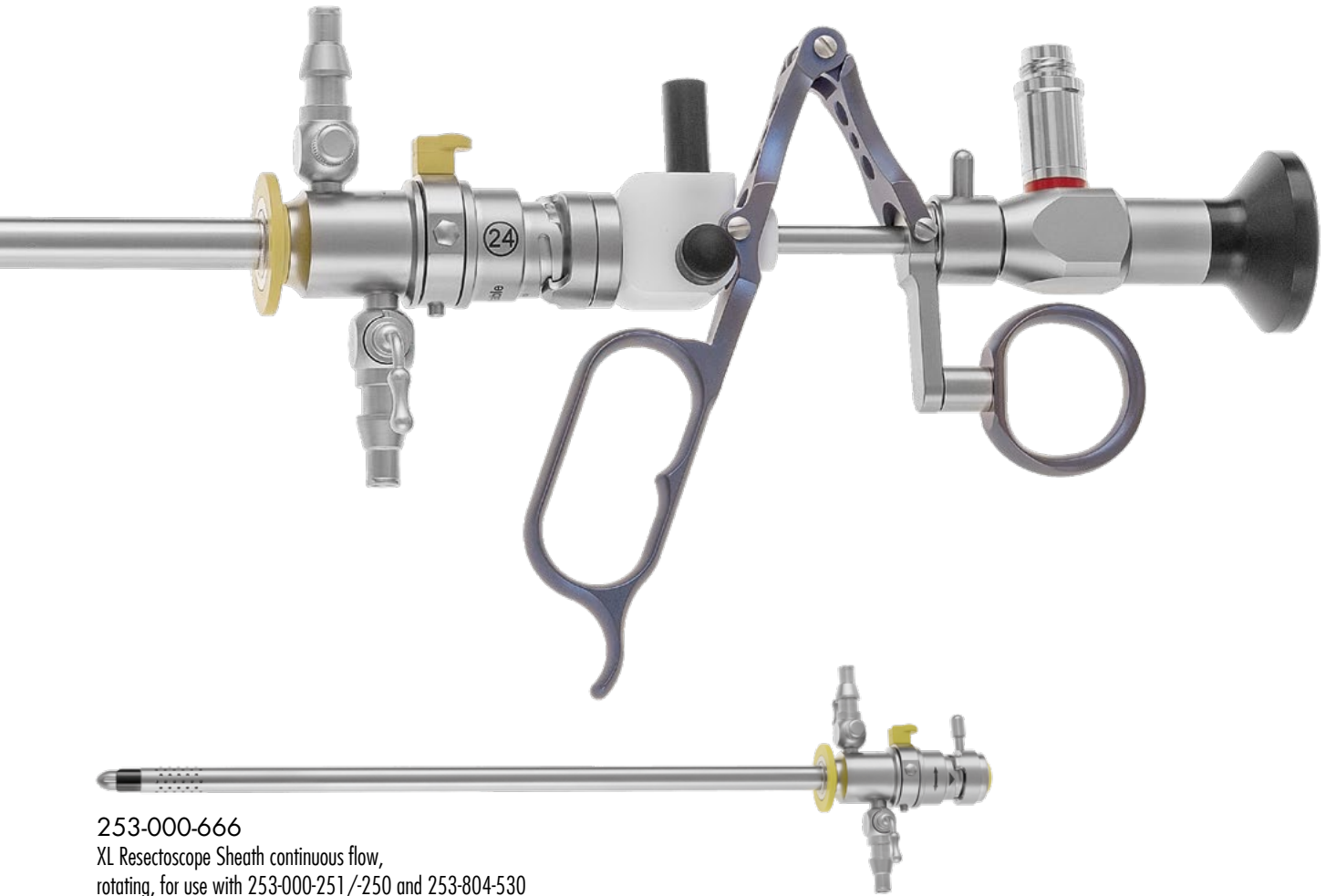

253-000-666
XL Resectoscope Sheath continuous flow,
rotating, for use with 253-000-251/-250 and 253-804-530

24 Charr. HYBRID Electrodes
XL Electrodes for use with RZ XL Resectoscope

| | | | |
|--|--|---------------------------|-------------|
| | | Cutting Loop, straight | 253-300-252 |
| | | Cutting Loop, 15° angled | 253-300-253 |
| | | Cutting Loop, 30° angled | 253-300-254 |
| | | Cutting Loop, 45° angled | 253-300-255 |
| | | Cutting Loop, 60° angled | 253-300-256 |
| | | Cutting Loop, 90° angled | 253-300-257 |
| | | Cutting Loop, 120° angled | 253-300-251 |
| | | Roller Electrode | 253-300-258 |
| | | Knife Electrode | 253-300-259 |

LASER THERAPY



- Photoselective vaporization of the prostate (PVP)
- Holmium laser ablation of the prostate (HoLAP / ThuVAP)
- Diode-Laser / Contact Laser Ablation
- Holmium laser enucleation of the prostate (HoLEP / ThuLEP)

A laser fiber introduced to an endoscopic instrument applies energy that removes tissue. Lasers use concentrated light to generate precise and intense heat to remove e.g. enlarged prostate - known as benign prostatic hyperplasia (BPH).

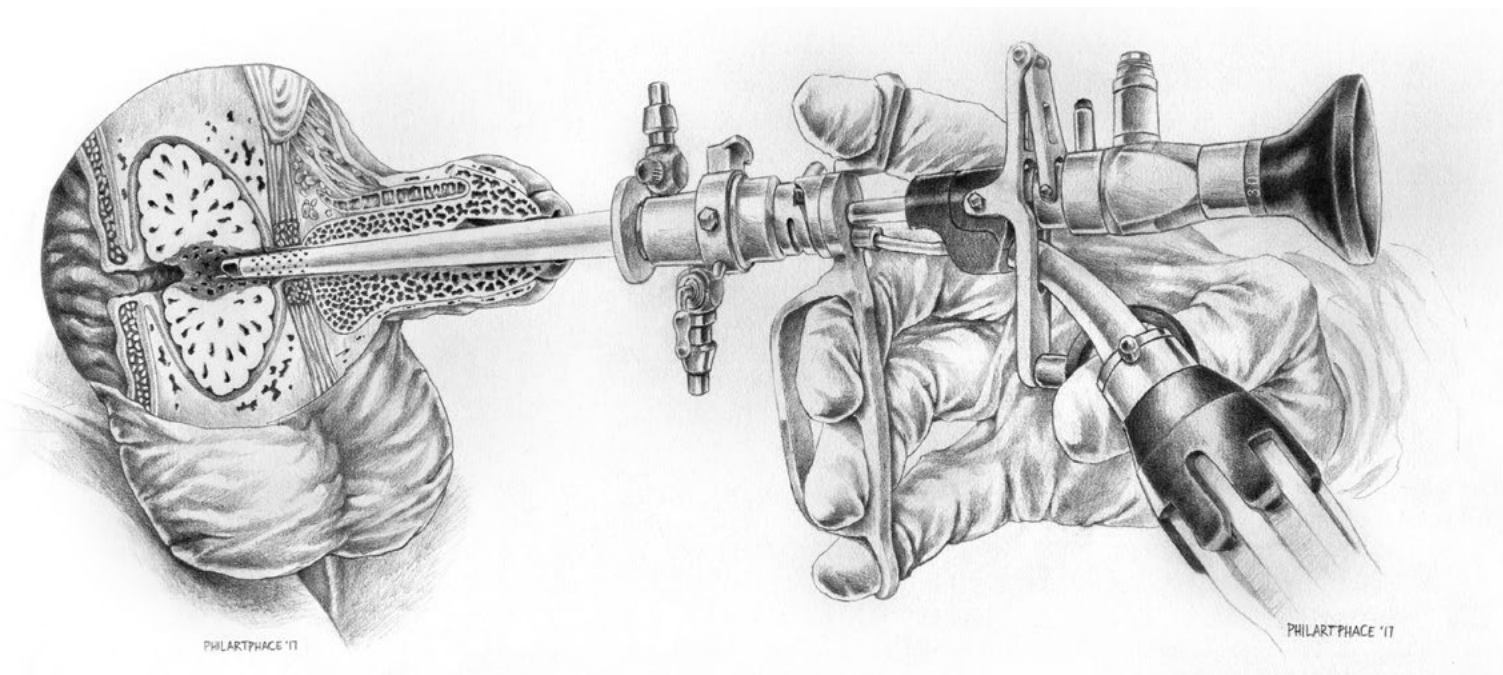



| | |
|---|---------------|
| PVP A laser (Greenlight) is used to vaporize tissue (melting away). | Pages 50 - 52 |
| HoLAP / ThuVAP Similar to PVP but uses a different type of laser e.g. Holmium Ablation or Thulium Vaporization. | Pages 50 - 52 |
| Diode-Laser / Contact Laser Ablation Dual laser length waves for ablation in combination with a hemostatic effect. e.g. TWISTER™ or XCAVATOR® procedures. | Page 53 |
| HoLEP / ThuLEP A laser is used to cut the tissue. Another instrument is needed to remove the prostate tissue e.g. Holmium enucleation or Thulium enucleation. | Pages 54 - 58 |

SIDE FIRE

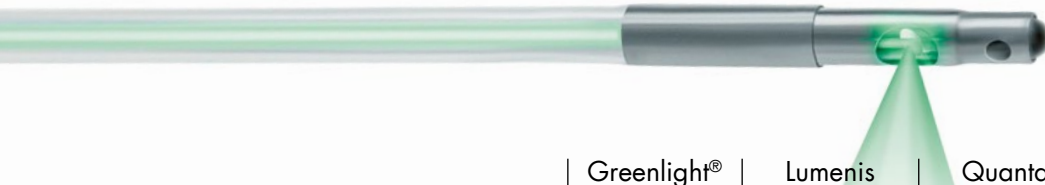
Lateral laser emission for PVP, HoLAP or ThuVAP

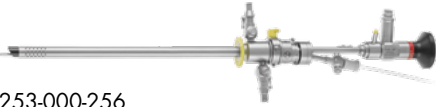

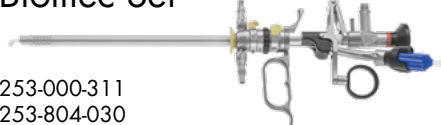



| | Greenlight® Fibers MoXy typical Ø 2.1mm, max. 2.3mm | Lumenis Xpeeda (Duotome) typical Ø 2.5mm | Quanta SideFiber typical Ø 2.22mm (+/- 5%) | Biolitec SideFiber 2100 typical Ø 2.4mm | Biolitec XCAVATOR Glass Tip |
|---|--|---|---|--|-----------------------------------|
| Cystoscope Set  253-870-023 253-872-000 (8 Charr. Laser Channel) 253-873-000 253-804-030 | + | + | + | + | - |
| Resection Set  253-000-256 253-874-000 (7 Charr. Laser Channel) 253-804-030 | + | - | + | - | + |
| Resectoscope Set  253-000-256 253-000-310 253-804-030 | + | + | + (no fixation) | + (no fixation) | - |
| Biolitec Set  253-000-311 253-804-030 253-000-656 | - | - | - | - | + |

+ compatible
- non-compatible

FRONT FIRE

Straight laser emission for HoLEP or ThuLEP

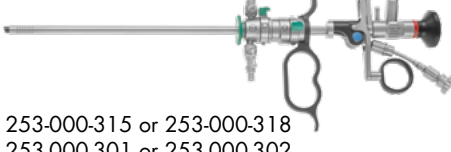

| | Lumenis Slimline, EZ, GI up to Ø 1.2mm, (3.6 Charr.) | Lisa Laser RigiFib-SV | Quanta Laser CyberTM | Boston Scientific AccuMax |
|---|---|--------------------------|-------------------------|---------------------------------|
| Resectoscope Set 24Charr.  253-000-300 or 253-000-312 253-000-301 or 253-000-302 300-011-184 (Ø 0.6 - 1.4 mm) 253-000-256 253-804-030 (Ø 4mm Endoscope) | + | + | + | + |
| Resectoscope Set 24Charr. detachable  253-000-305 253-000-320 or 253-000-333 253-000-301 or 253-000-302 300-011-184 (Ø 0.6 - 1.4mm) 253-000-256 253-804-030 (Ø 4mm Endoscope) | + | + | + | + |
| Resectoscope Set 22Charr.  253-000-316 or 253-000-319 253-000-301 or 253-000-302 300-011-184 (Ø 0.6 - 1.4 mm) 253-000-352 351-829-030 (Ø 2.9mm Endoscope) | + | + | + | + |
| Resectoscope Set 18.5Charr.  253-000-315 or 253-000-318 253-000-301 or 253-000-302 300-011-184 (Ø 0.6 - 1.4 mm) 351-000-185 351-829-030 | + | + | + | + |
| Morcellation Set  253-000-256 253-428-100 253-900-121 | + | + | + | + |

Universal Laser Cystoscope

mainly used for *PVP, HoLAP or ThuVAP*
compatible with all laser fibres up to 2.5mm



253-804-030 30° direction of view
253-804-012 12° direction of view
RZ Rod Lens Cystoscope, autoclavable, Ø 4.0mm

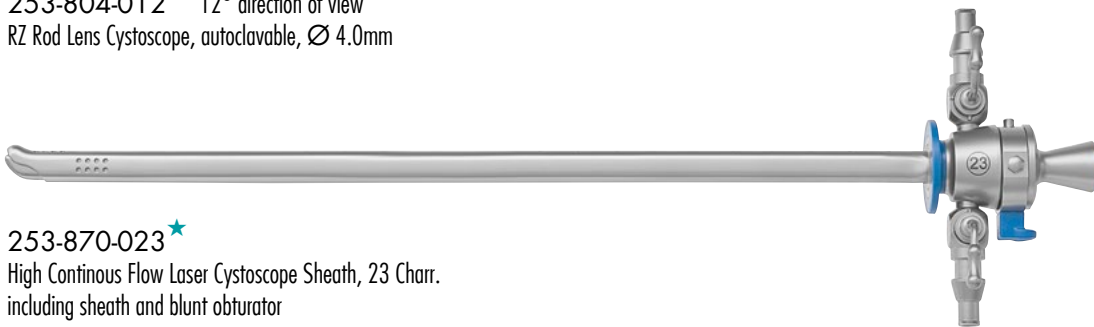

253-870-023★
High Continuous Flow Laser Cystoscope Sheath, 23 Charr.
including sheath and blunt obturator



253-872-000★
Telescope bridge and laser guide with 1 working channel
for 8 Charr. laser fibers and instruments



253-873-000
Visual Obturator for easy insertion of the sheath
into the urethra and bladder

Laser Resection for PVP, HoLAP or ThuVAP

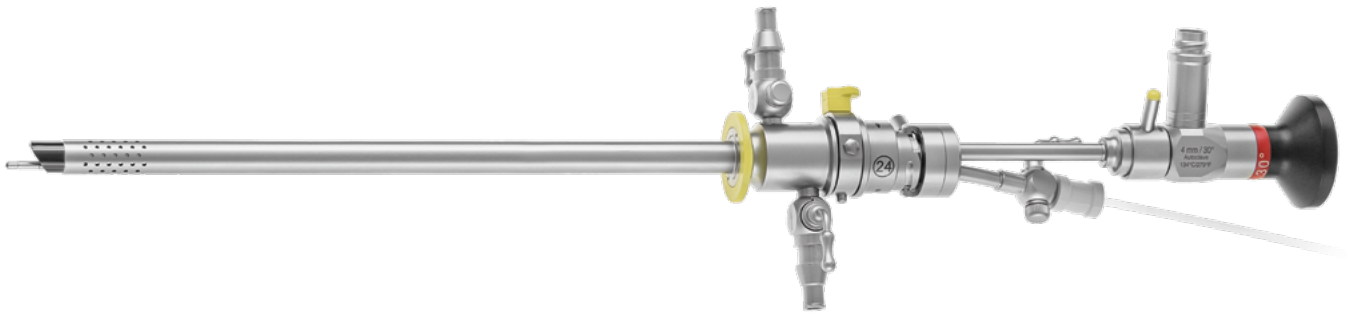

253-804-030 30° direction of view
253-804-012 12° direction of view
RZ Rod Lens Cystoscope, autoclavable, Ø 4.0mm

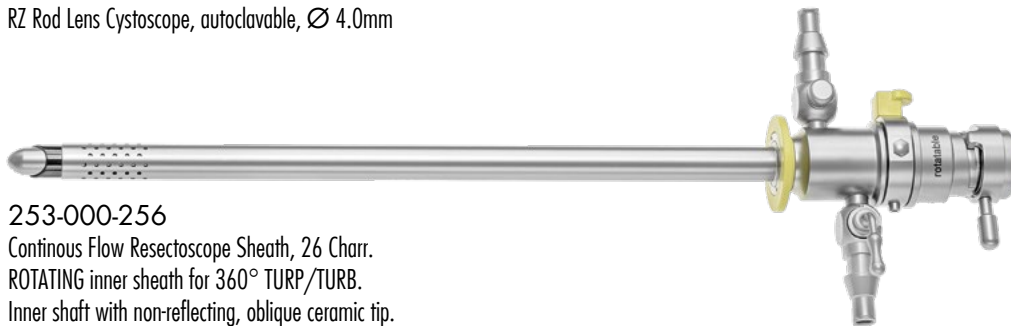

253-000-256
Continuous Flow Resectoscope Sheath, 26 Charr.
ROTATING inner sheath for 360° TURP/TURB.
Inner shaft with non-reflecting, oblique ceramic tip.
New RZ QuickLock mechanism for easy and fast assembling/disassembling.



253-874-000
Laser Working Insert with 7 Charr. working channel,
for 24/26 Charr. sheaths and 4mm telescope

Laser Resection for PVP, HoLAP or ThuVAP

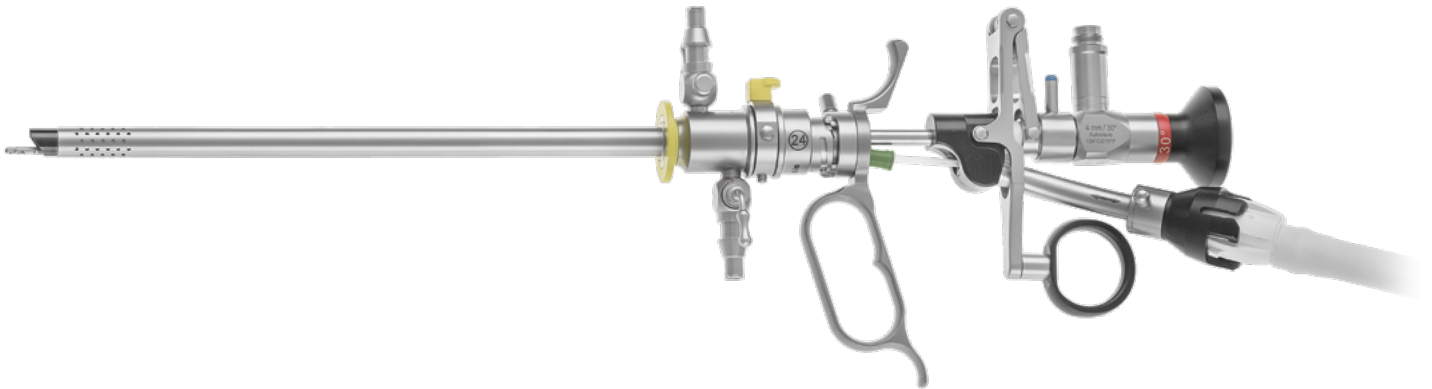

253-804-030 30° direction of view
 253-804-012 12° direction of view
 RZ Rod Lens Cystoscope, autoclavable, Ø 4.0mm



253-000-310
 RZ Laser Working Element, passive
 for laser probes Greenlight

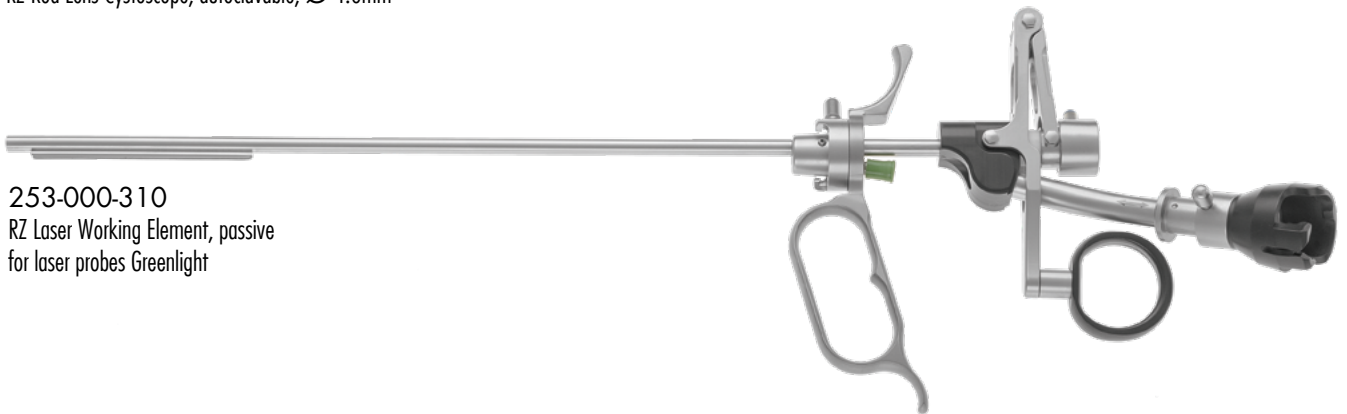

253-000-256
 Continuous Flow 26 Charr. Resectoscope Sheath with rotating inner
 sheath and non-reflecting ceramic tip, including atraumatic obturator

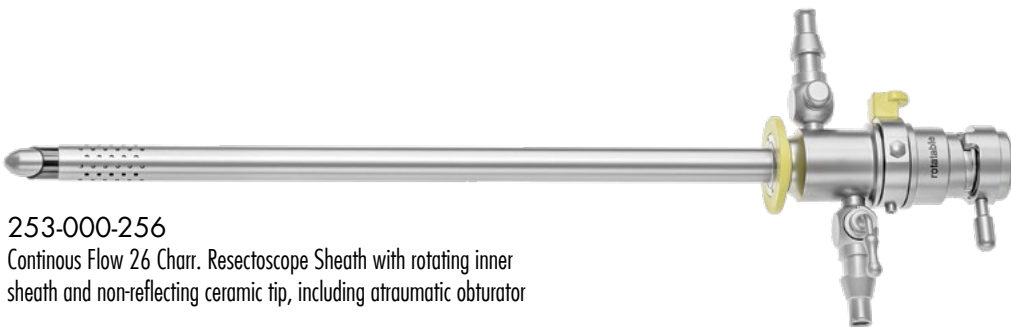

Laser Resection

for *Biolitec Xcavator / Twister*

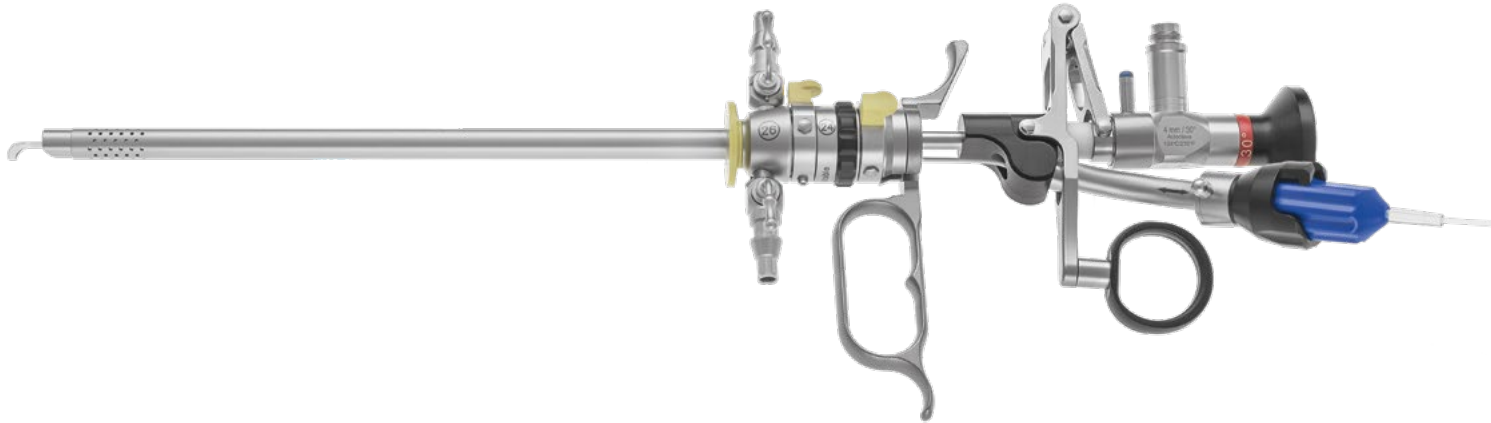

253-804-030 30° direction of view
 253-804-012 12° direction of view
 RZ Rod Lens Cystoscope, autoclavable, Ø 4.0mm

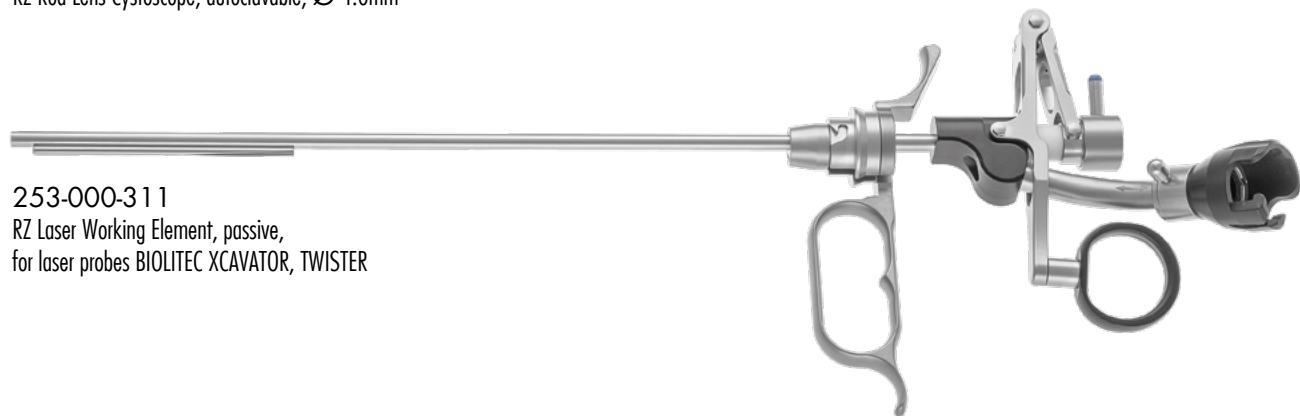

253-000-311
 RZ Laser Working Element, passive,
 for laser probes BIOLITEC XCAVATOR, TWISTER



253-000-656
 Resectoscope Sheath, Continuous Flow
 complete, 26Charr, rotatable,
 for Biolitec Xcavator

Laser Resection Straight laser emission for *HoLEP* or *ThuLEP*

HoLEP Set acc. Dr. Felipe C. A. de Figueiredo

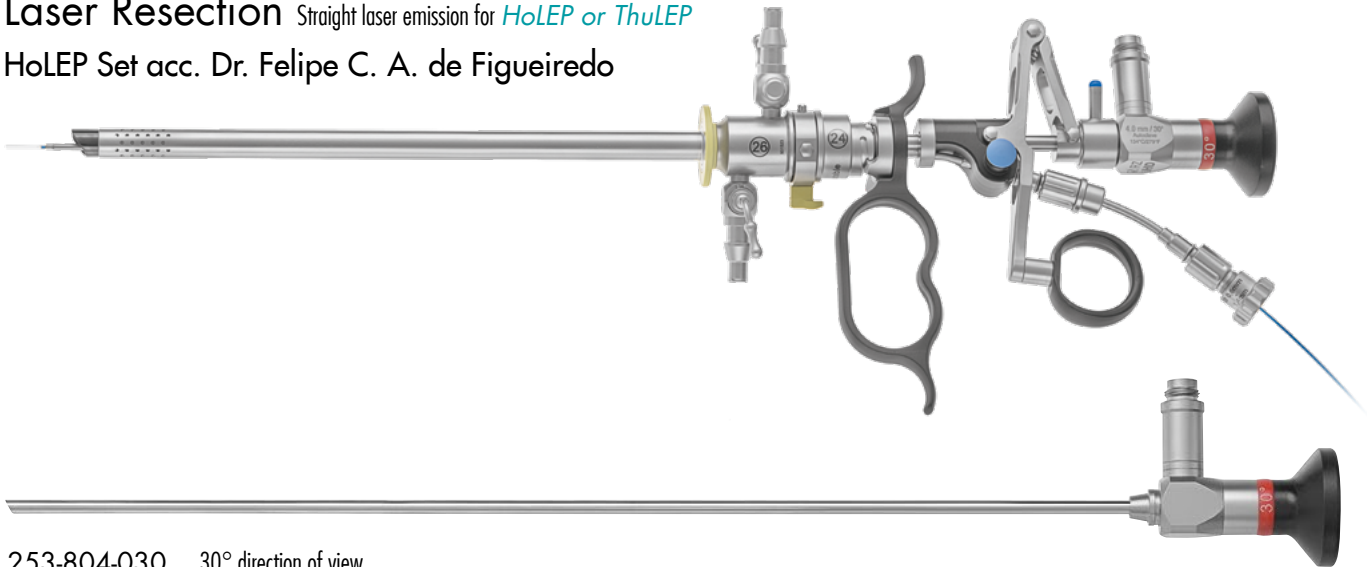

253-804-030 30° direction of view
 253-804-012 12° direction of view
 RZ Rod Lens Cystoscope, autoclavable, Ø 4.0mm

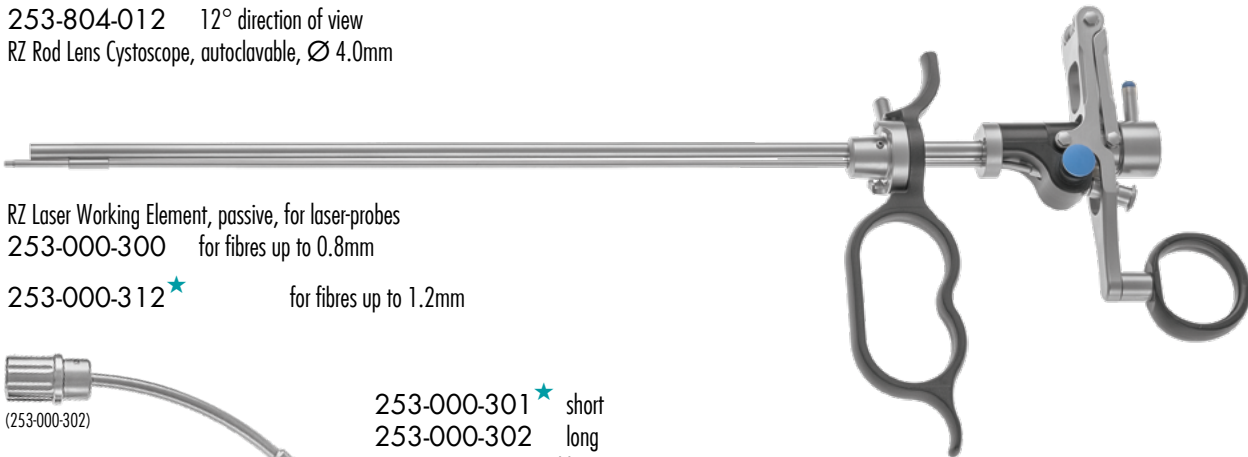

RZ Laser Working Element, passive, for laser-probes
 253-000-300 for fibres up to 0.8mm
 253-000-312★ for fibres up to 1.2mm



(253-000-302)

253-000-301★ short
 253-000-302 long
 RZ LL-Connection, rotatable
 for use with Laser Probe

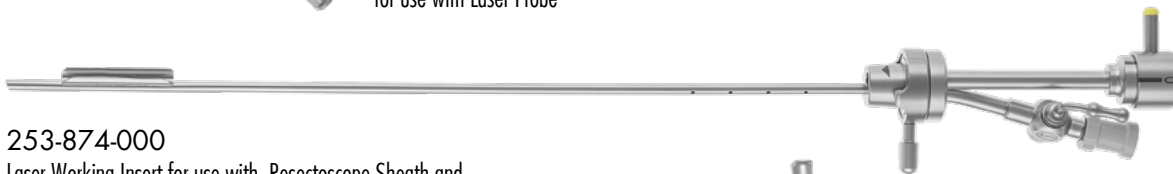

253-874-000
 Laser Working Insert for use with Resectoscope Sheath and
 4mm Cystoscope with 7 Charr. working channel

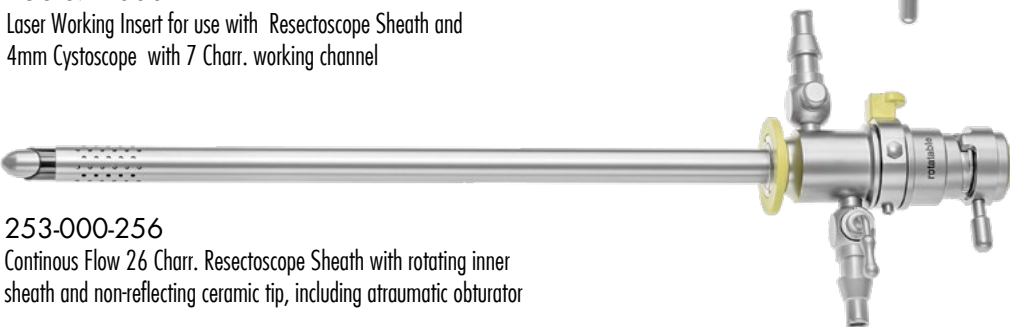

253-000-256
 Continous Flow 26 Charr. Resectoscope Sheath with rotating inner
 sheath and non-reflecting ceramic tip, including atraumatic obturator



300-011-184★
 Luer-Lock Tuohy Borst Adapter
 (Ø 0.6 - 1.4mm)

Laser Resection Straight laser emission for *HoLEP* or *ThuLEP*

HoLEP Set acc. Dr. Felipe C. A. de Figueiredo

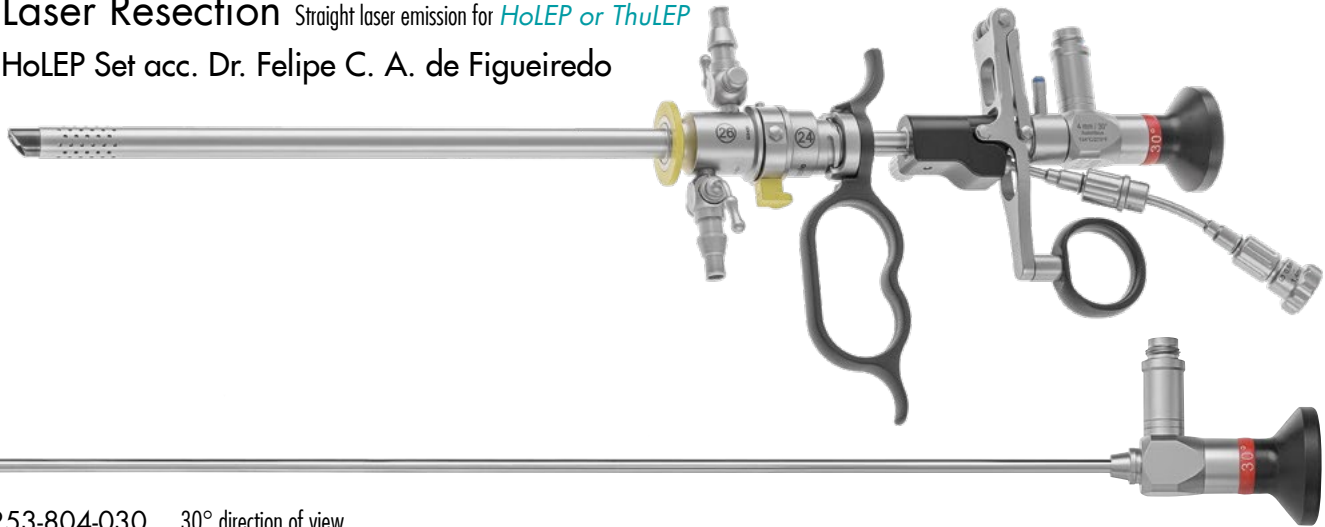

253-804-030 30° direction of view
 253-804-012 12° direction of view
 RZ Rod Lens Cystoscope, autoclavable, Ø 4.0mm

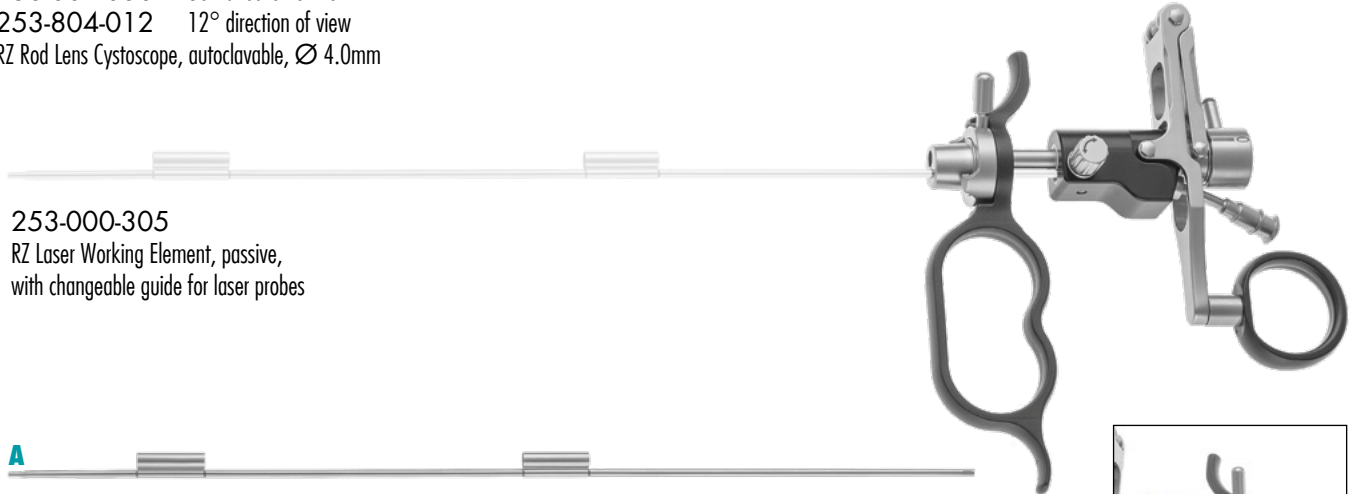

253-000-305
 RZ Laser Working Element, passive,
 with changeable guide for laser probes

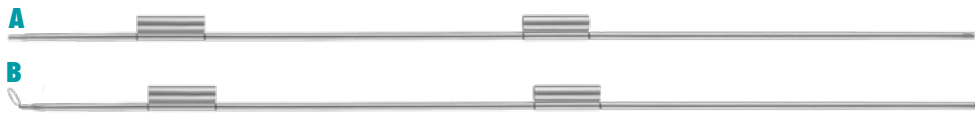

| A Guide for Laser Probes | | B Guide for Laser Probes, with retractor | |
|--------------------------|-------|--|-------|
| 253-000-320 | 0.8mm | 253-000-330 | 0.8mm |
| 253-000-321 | 1.0mm | 253-000-331 | 1.0mm |
| 253-000-322 | 1.2mm | 253-000-332 | 1.2mm |
| 253-000-323 | 1.4mm | 253-000-333 | 1.4mm |

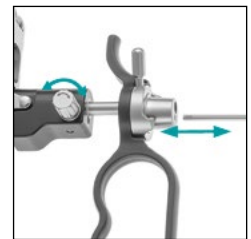

detachable

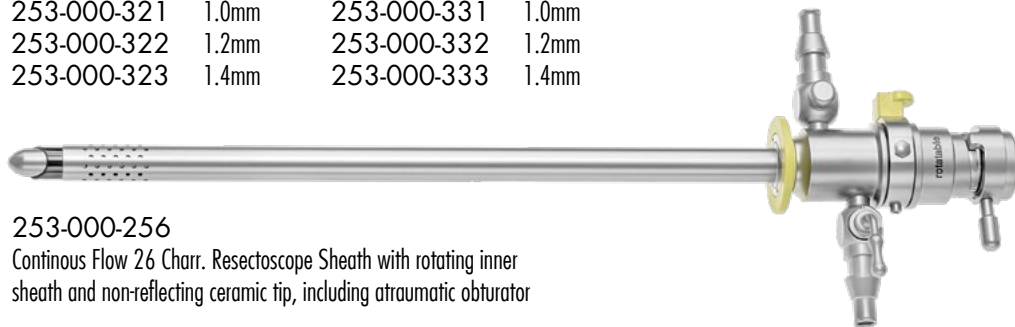

253-000-256
 Continuous Flow 26 Charr. Resectoscope Sheath with rotating inner
 sheath and non-reflecting ceramic tip, including atraumatic obturator

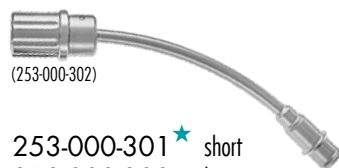

253-000-301 ★ short
 253-000-302 long
 RZ LL-Connection, rotatable
 for use with Laser Probe



300-011-184
 Luer-Lock Tuohy Borst Adapter
 (Ø 0.6 - 1.4mm)

Laser Resection 22Charr.

Straight laser emission for *HoLEP* or *ThuLEP*

HoLEP Set acc. Dr. Felipe C. A. de Figueiredo

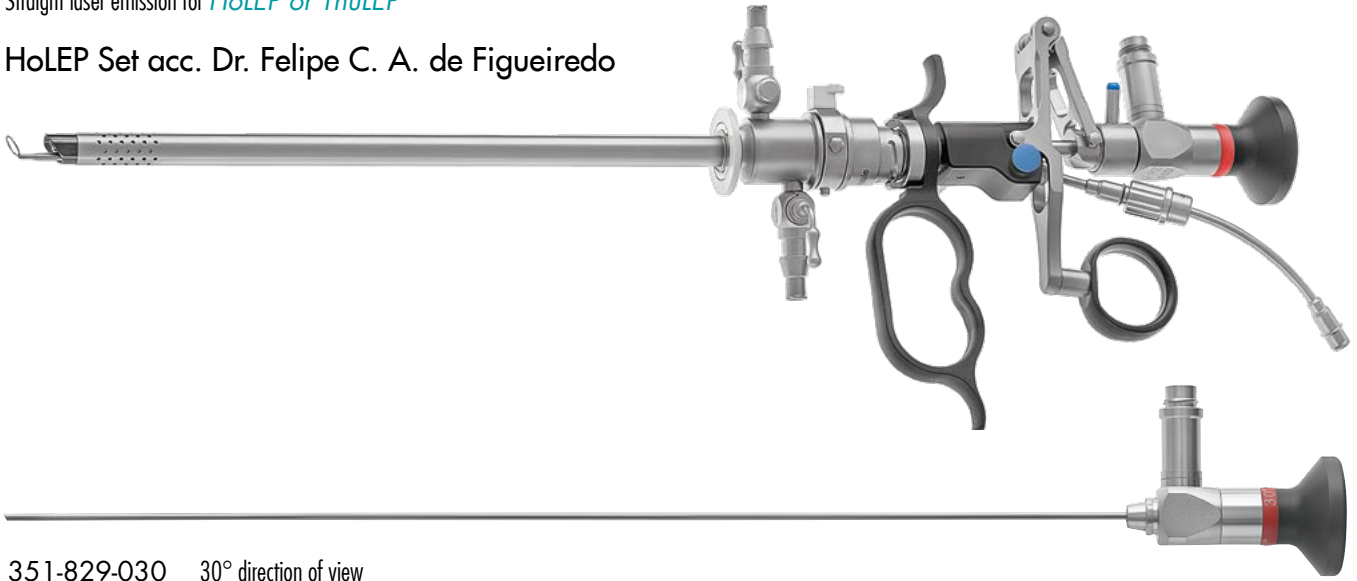

351-829-030 30° direction of view
 351-829-012 12° direction of view
 RZ Rod Lens Cystoscope, autoclavable, Ø 2.9mm



RZ Laser Working Element, passive, for laser-probes
 253-000-319 for fibres up to 0.8mm
 253-000-316 for fibres up to 1.2mm

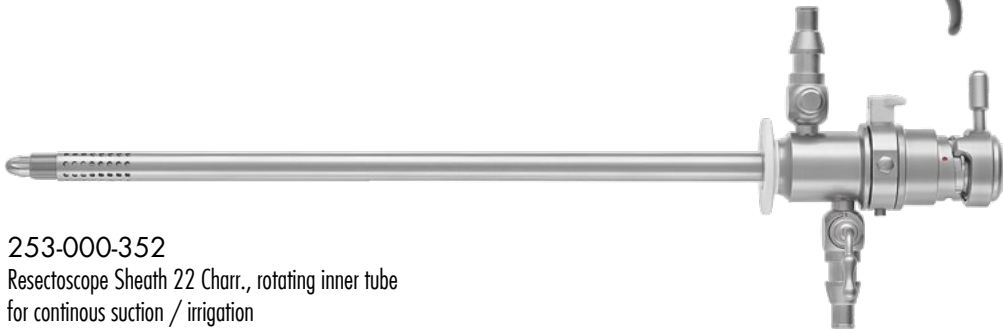

253-000-352
 Resectoscope Sheath 22 Charr., rotating inner tube
 for continuous suction / irrigation

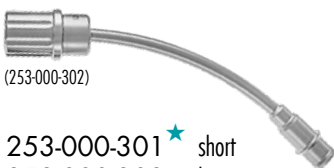

253-000-301 ★ short
 253-000-302 long
 RZ LL-Connection, rotatable
 for use with Laser Probe

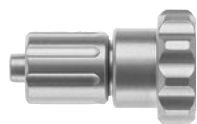

300-011-184
 Luer-Lock Tuohy Borst Adapter
 (Ø 0.6 - 1.4mm)

Laser Resection 18.5Charr.

Straight laser emission for *HoLEP* or *ThuLEP*

HoLEP Set acc. Dr. Felipe C. A. de Figueiredo

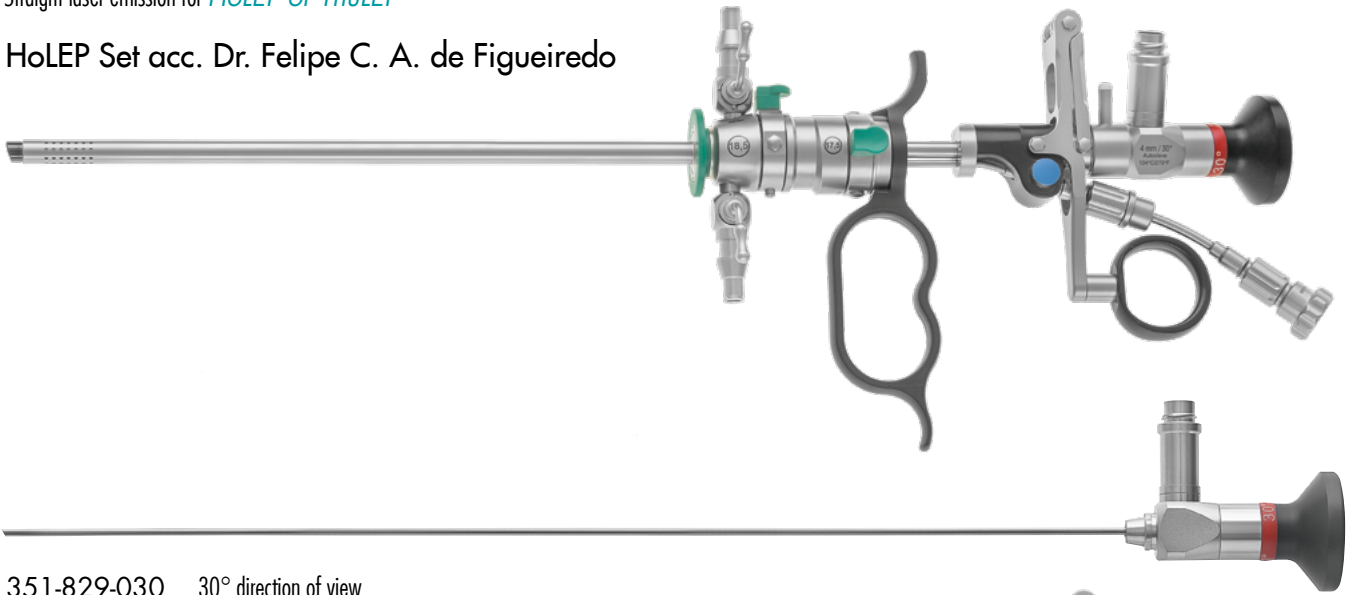

351-829-030 30° direction of view
 351-829-012 12° direction of view
 RZ Rod Lens Cystoscope, autoclavable, Ø 2.9mm



RZ Laser Working Element, passive, for laser-probes with fibres up to 0.8mm
 253-000-315 **without** push button
 253-000-318 **with** push button

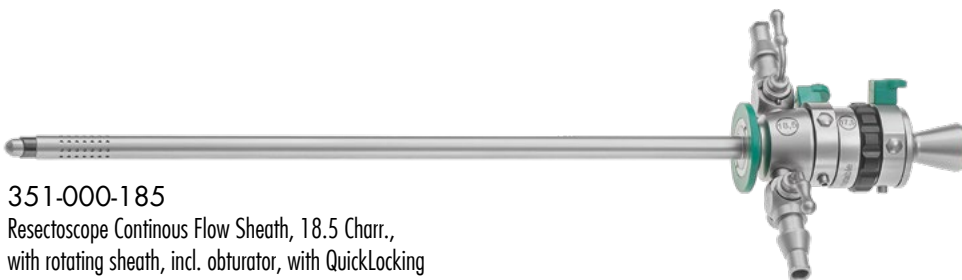

351-000-185
 Resectoscope Continuous Flow Sheath, 18.5 Charr.,
 with rotating sheath, incl. obturator, with QuickLocking

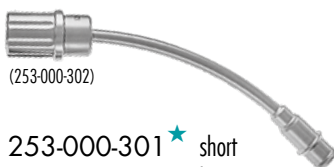

253-000-301 **★** short
 253-000-302 long
 RZ LL-Connection, rotatable
 for use with Laser Probe



300-011-184
 Luer-Lock Tuohy Borst Adapter
 (Ø 0.6 - 1.4mm)

Tissue Morcellation

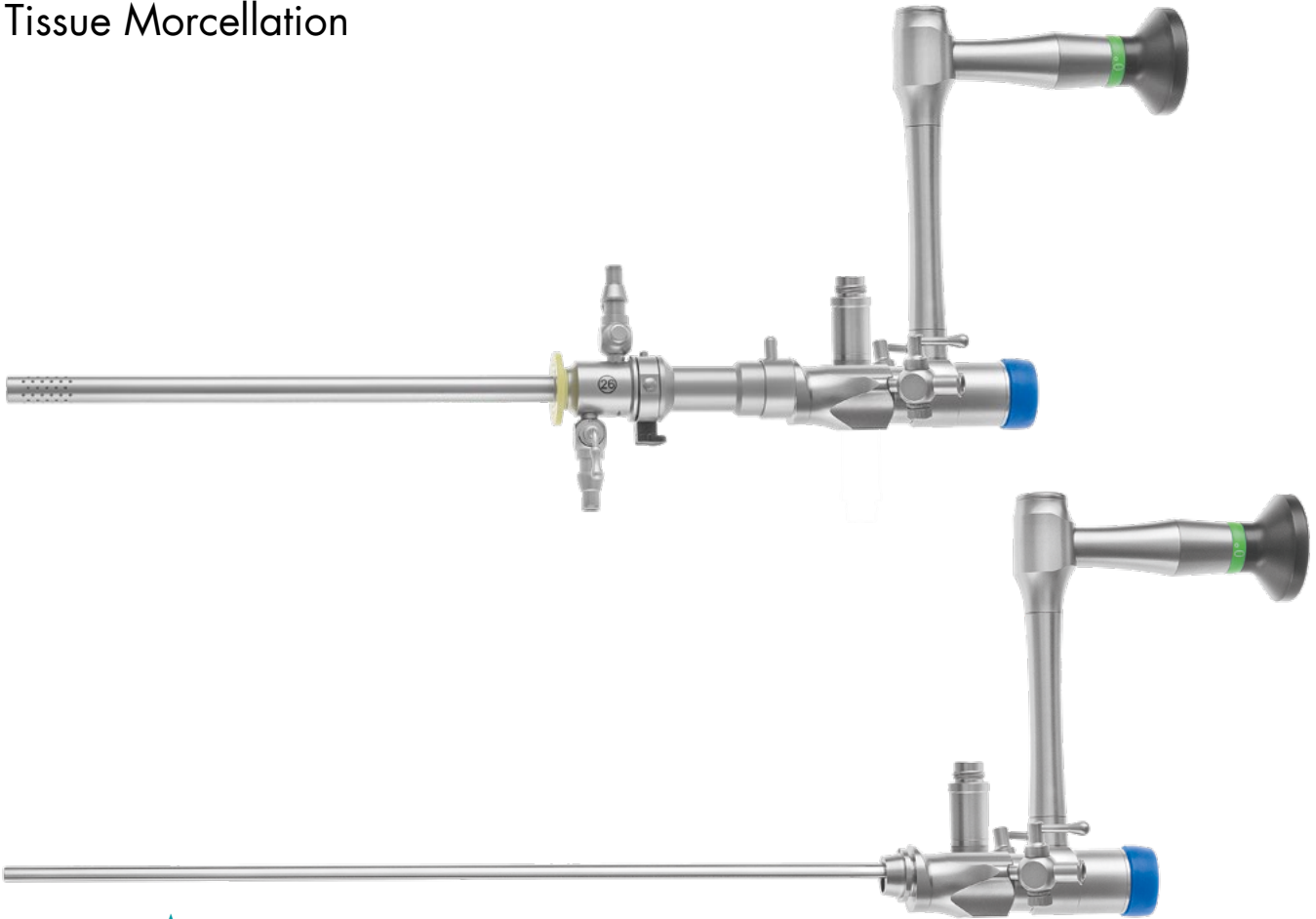

253-900-121 ★
Nephroscope 6°, oval instrument channel, parallel eye piece,
250mm working length



253-428-100 ★
Adapter for use with RZ Nephroscopes and
Resectoscope Outer sheaths 253-000-356/-256

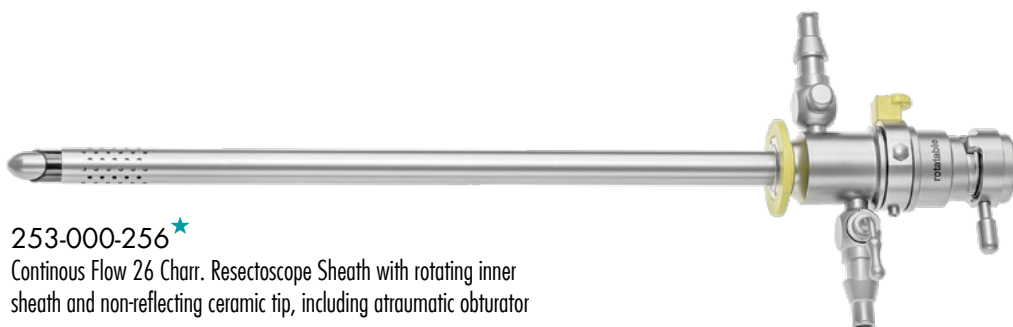

253-000-256 ★
Continuous Flow 26 Charr. Resectoscope Sheath with rotating inner
sheath and non-reflecting ceramic tip, including atraumatic obturator

XL Laser Resection

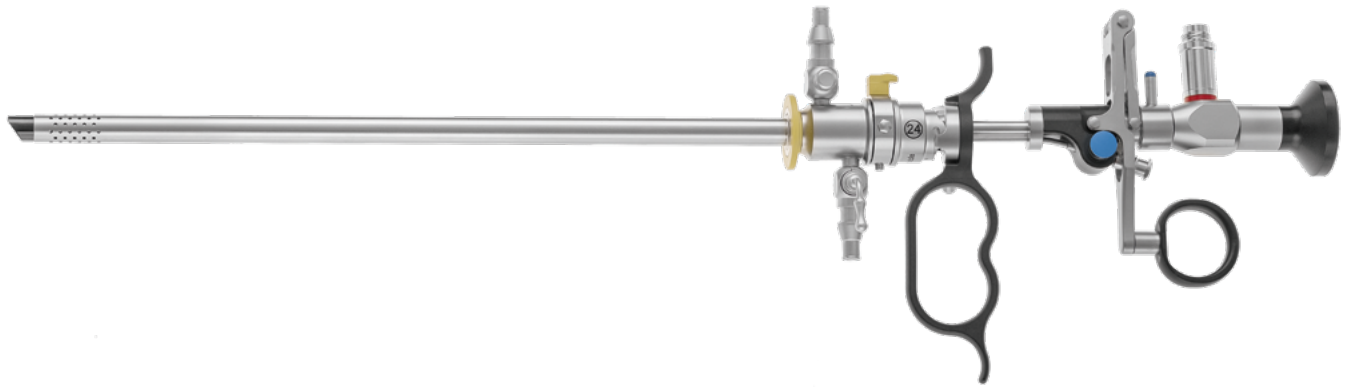

253-804-530
 XL Cystoscope, Ø 4mm, 30° direction of view,
 365mm length



253-000-350
 XL Laser Resectoscope for fibers Ø1.2mm, passive



253-000-666
 XL Resectoscope Sheath continuous flow,
 rotating, for use with 253-000-251/-250 and 253-804-530



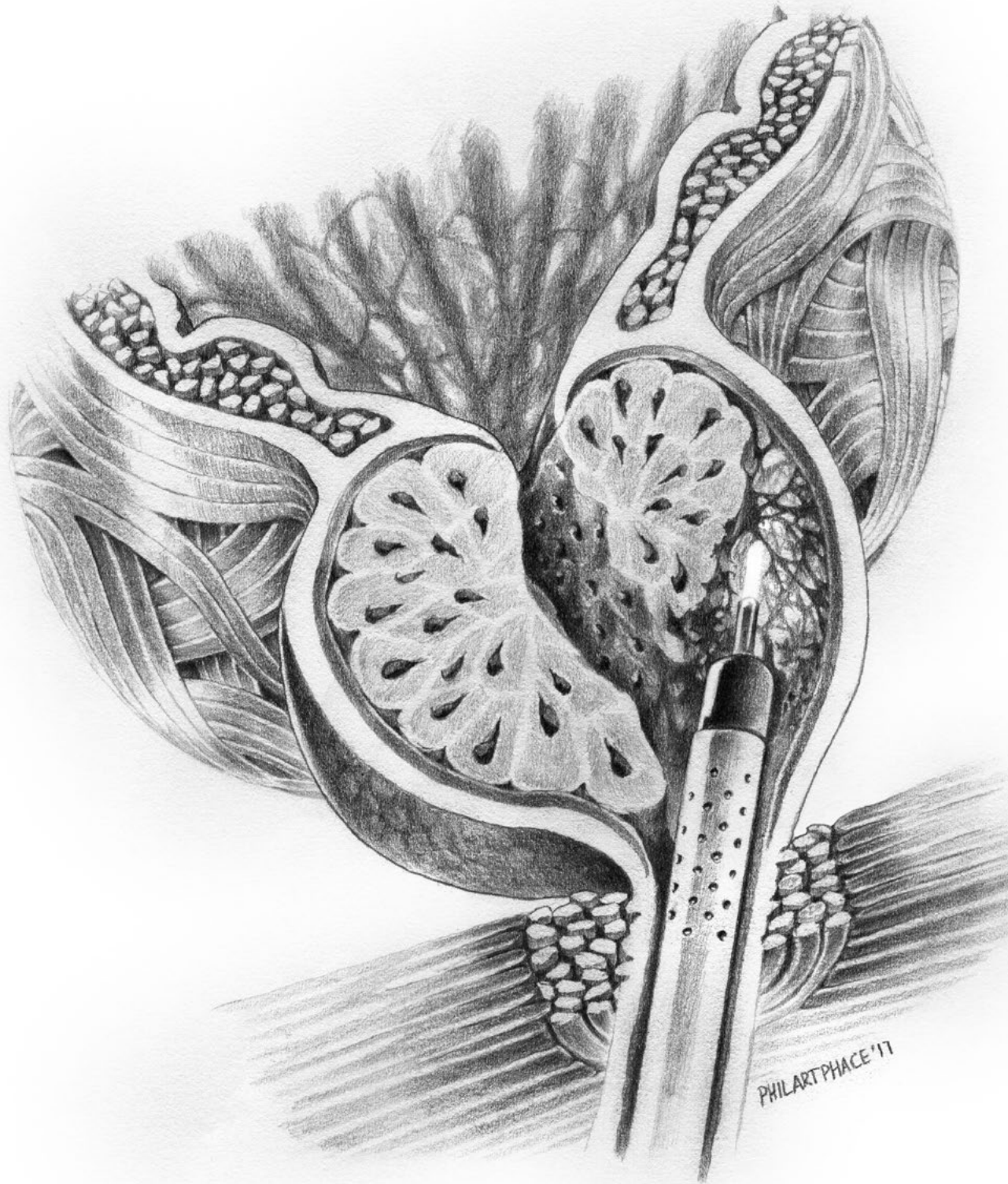



- 253-500-100 OTIS Dilation Urethrotome complete with 3 atraumatic tips and 2 knives, in wooden case
- 253-500-103 Wooden case only

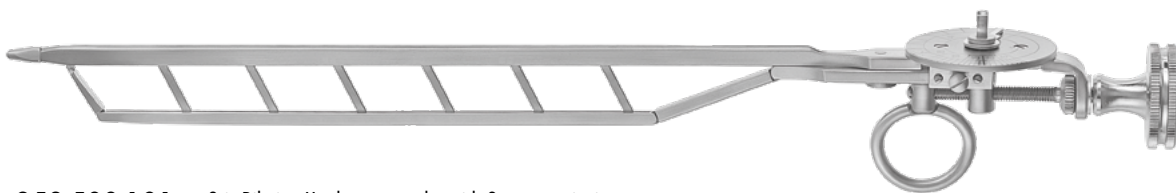

- 253-500-101 Otis Dilation Urethrotome only, with 3 atraumatic tips



- 253-500-102 Knife only



- 253-500-108 Set with 3 atraumatic tips only

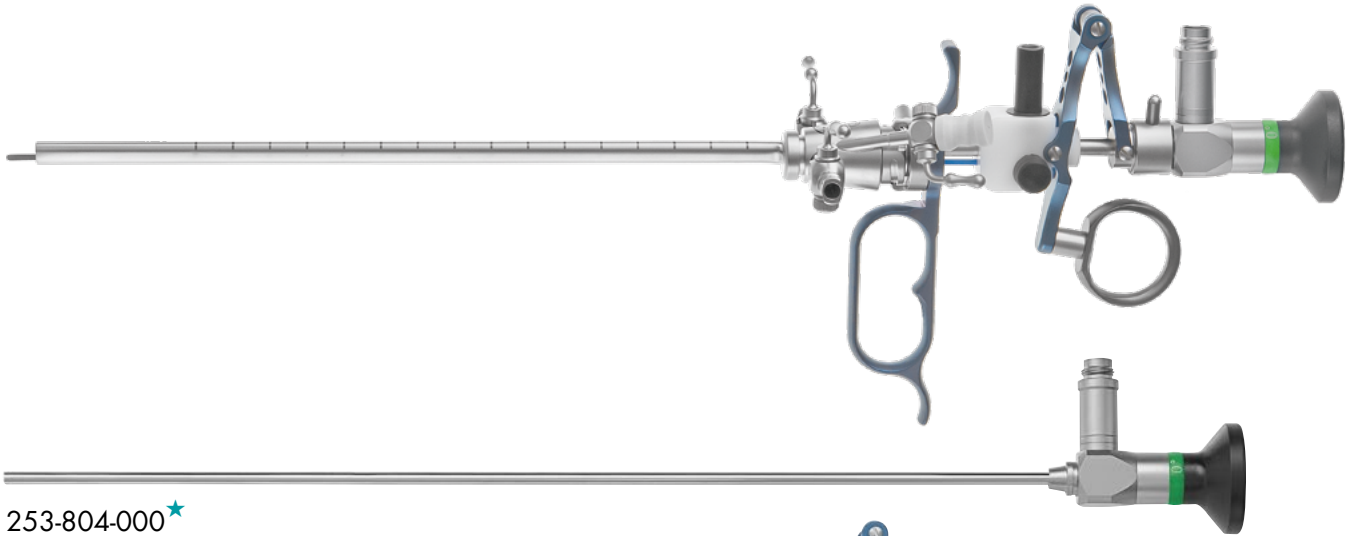

253-804-000★
RZ Cystoscope, 0°, Ø 4mm, autoclavable

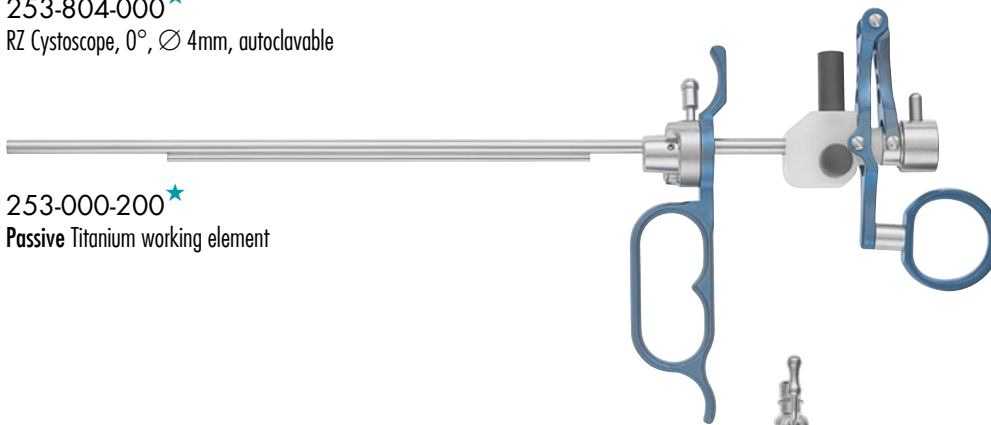

253-000-200★
Passive Titanium working element

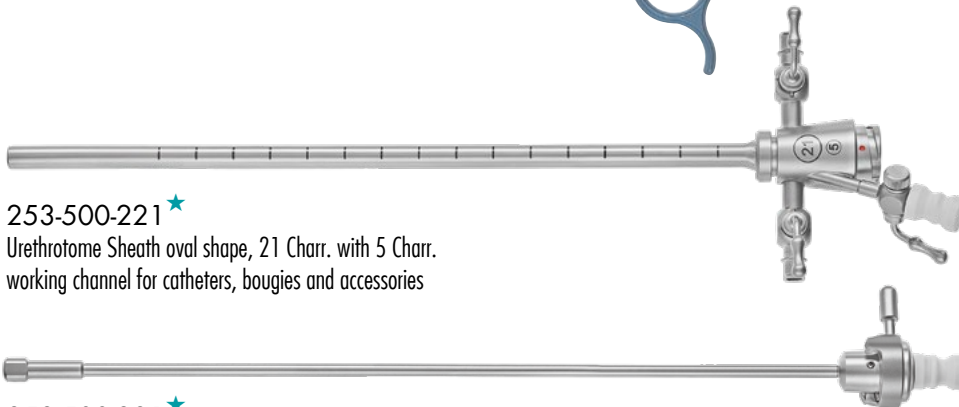

253-500-221★
Urethrotome Sheath oval shape, 21 Charr. with 5 Charr. working channel for catheters, bougies and accessories



253-500-321★
Hollow Obturator with channel for guide wires



253-500-230★
Supplementary Sheath, half round, to insert Foley catheters. Double Lock for secure fixation on the Urethrotome Sheath



253-500-229
Continuous Flow supplementary sheath with Double Lock for secure fixation on the Urethrotome Sheath



253-500-325
Bridge with channel for 5 Charr. accessories



1 guide stem Urethrotome knives, for use without HF



253-500-561 ★ Sachse knife, straight



253-500-562 Sickle knife, retrograde



253-500-563 ★ Half round knife, 180° cutting



253-500-564 WaveCut knife, straight



253-300-999 ★ Storage container for knives and electrodes, metal, perforated

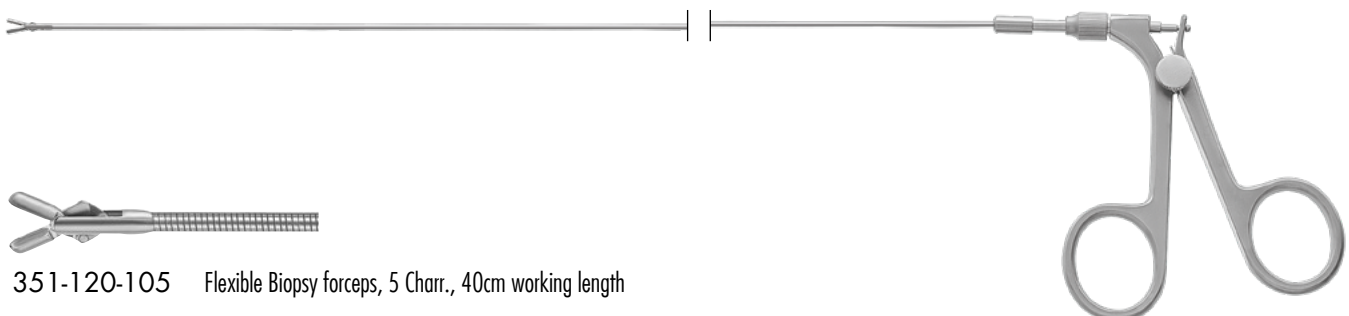

351-120-105 Flexible Biopsy forceps, 5 Charr., 40cm working length



URETHROTOME

SLIMLINE
Visual Urethrotome

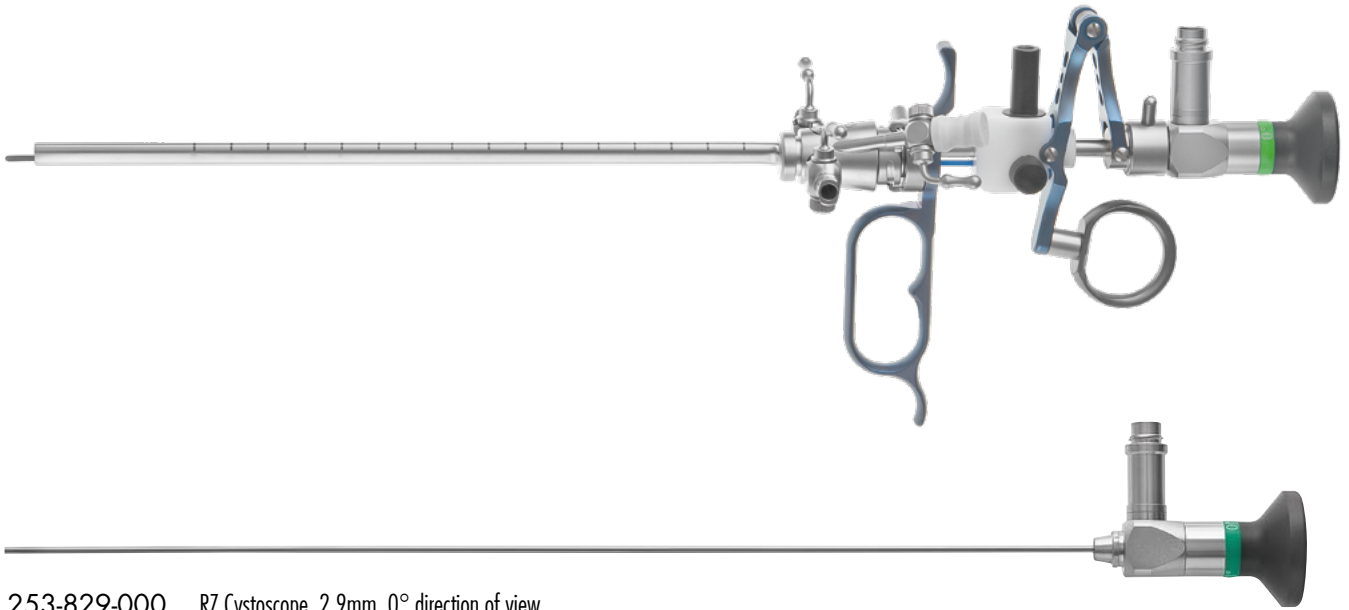

253-829-000 RZ Cystoscope, 2.9mm, 0° direction of view



253-500-500
Urethrotome Working Element for use with 2.9mm, 0° RZ Cystoscope

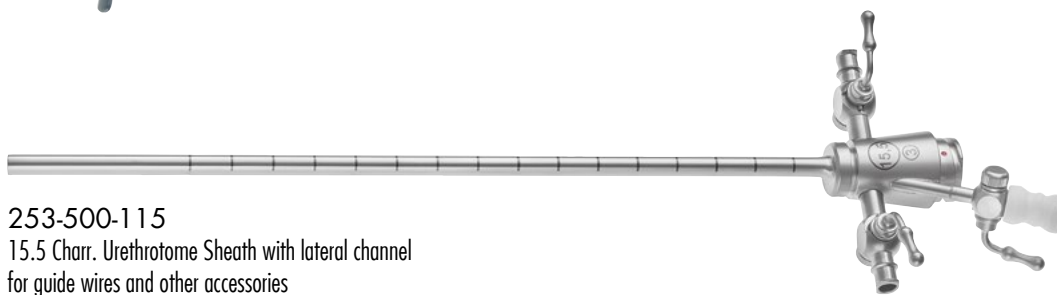

253-500-115
15.5 Charr. Urethrotome Sheath with lateral channel
for guide wires and other accessories



253-500-315
Obturator for use with 253-500-115



253-500-581 Sachse knife, straight, 15 Charr.



253-500-582 Sickle knife, retrograde, 15 Charr.



253-300-999 Storage container for knives and electrodes, metal, perforated



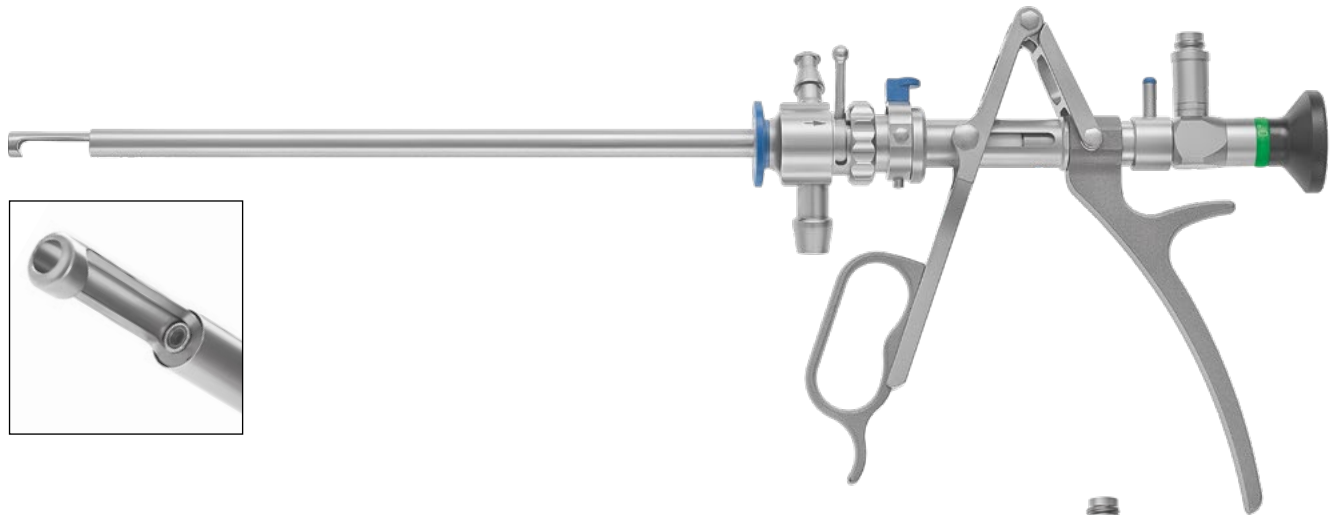

253-804-000★
RZ Cystoscope, 0°, Ø 4mm, autoclavable

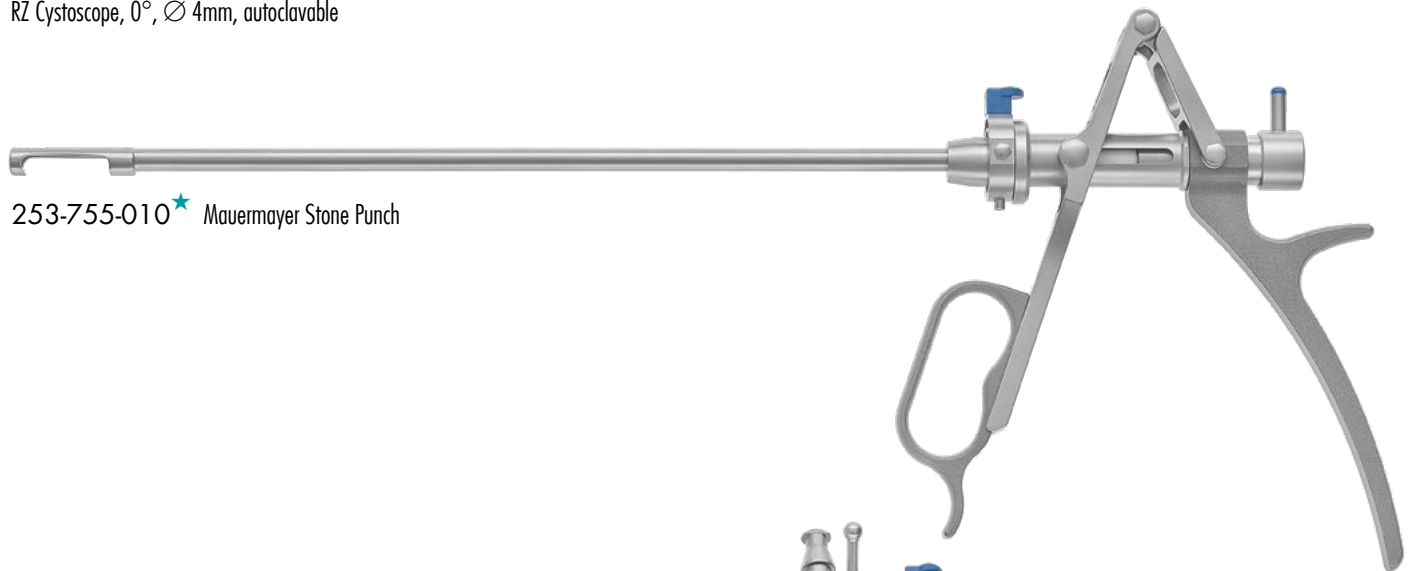

253-755-010★ Mauermayer Stone Punch

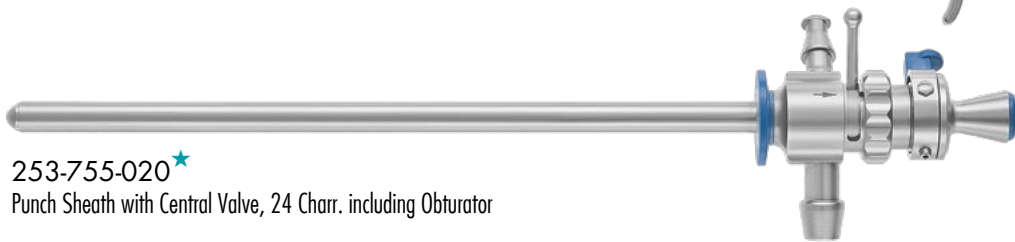

253-755-020★
Punch Sheath with Central Valve, 24 Charr. including Obturator



253-755-030
Visual Obturator with 7 Charr. working channel



253-755-040
Obturator only

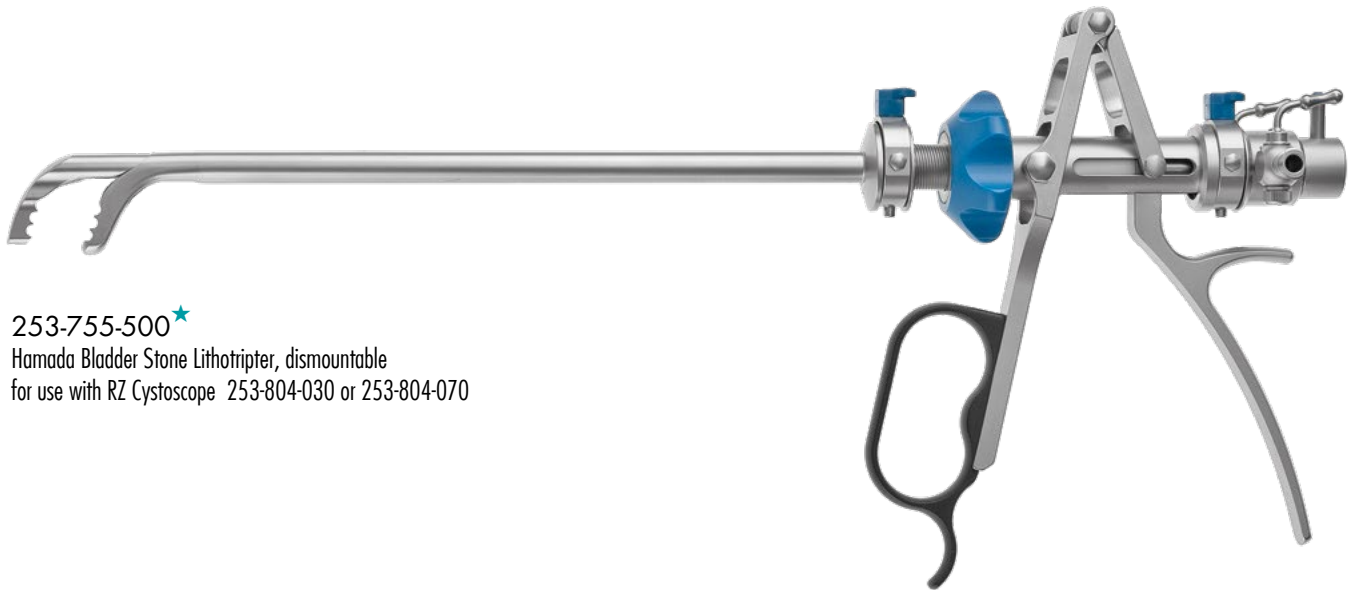

253-755-500★
Hamada Bladder Stone Lithotripter, dismantable
for use with RZ Cystoscope 253-804-030 or 253-804-070

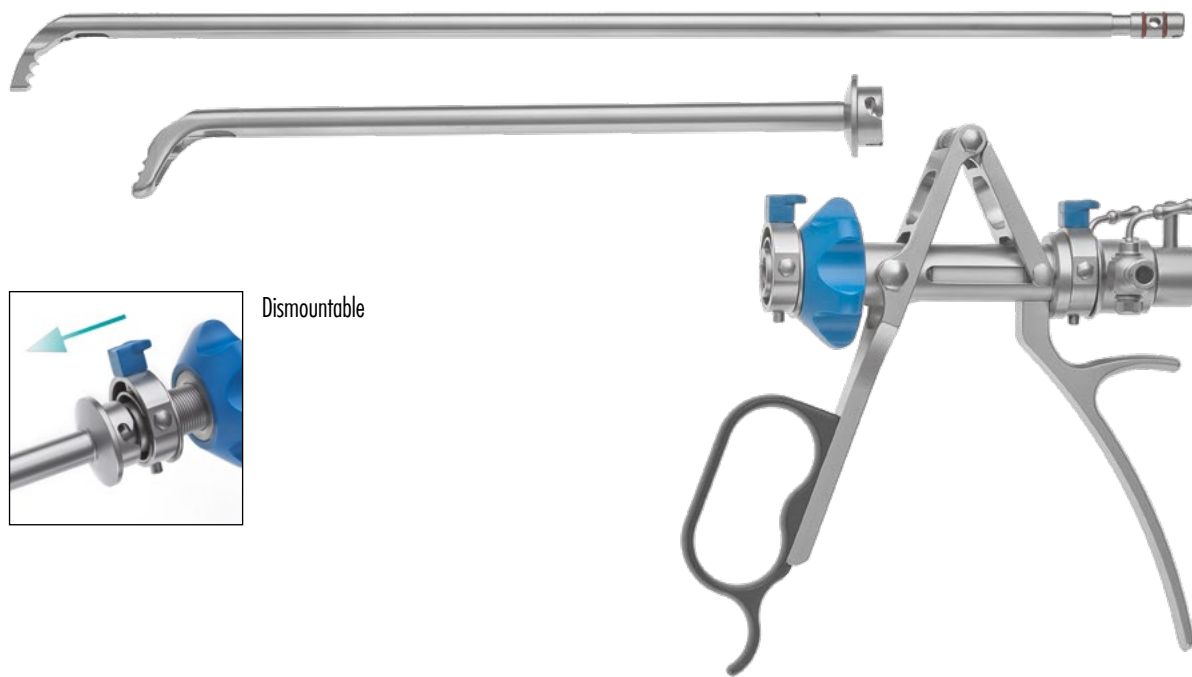

Dismountable

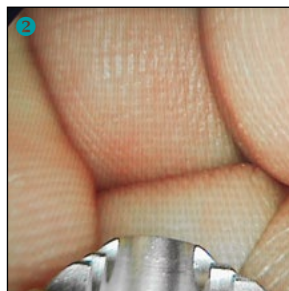
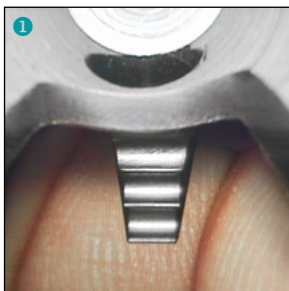

Comparison: field of view
 ❶ with 30° scope
 ❷ with 70° scope



253-760-000★
Stone Crushing Forceps for small stones, single action



For use with 25 Charr. Cystoscope Sheath

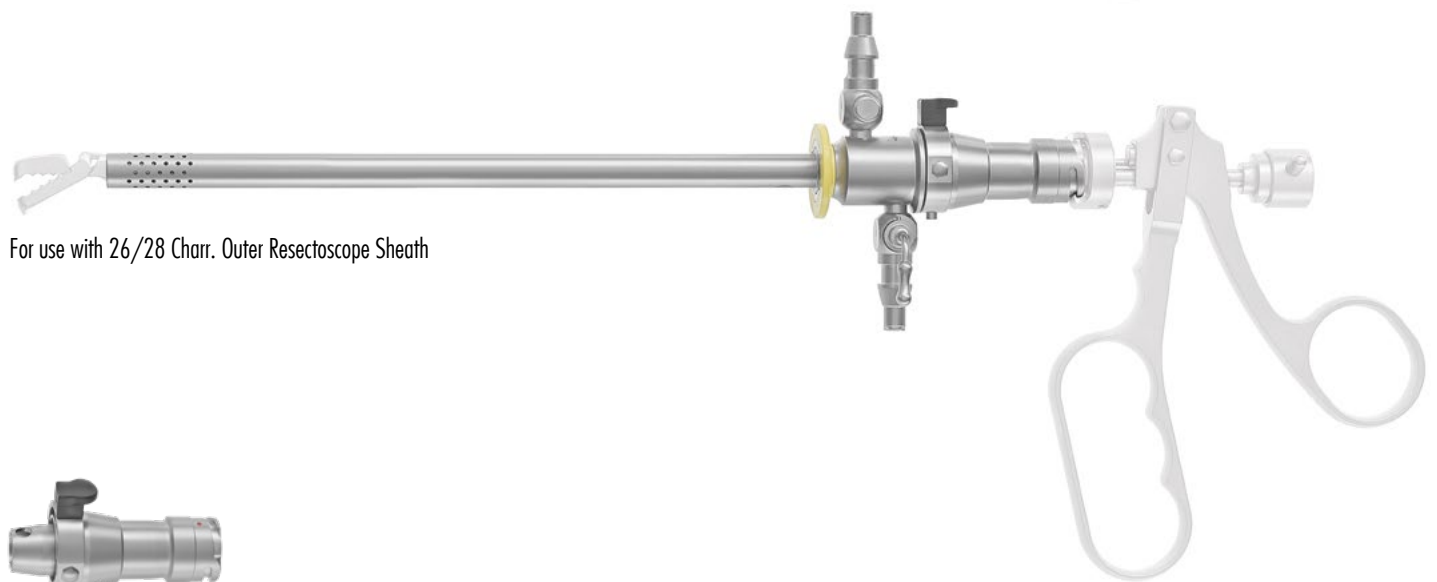

For use with 26/28 Charr. Outer Resectoscope Sheath



253-430-100★
Adapter for use with Outer Resectoscope Sheaths

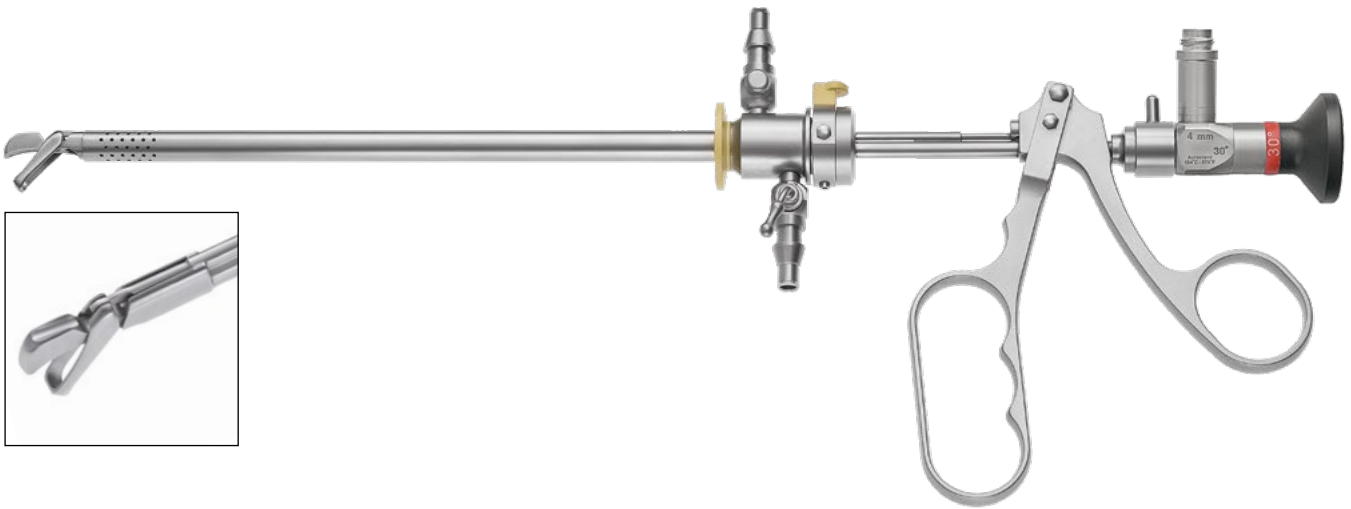

253-780-000
Tissue Punch to cut up denatured tissue
after Prostate Resection

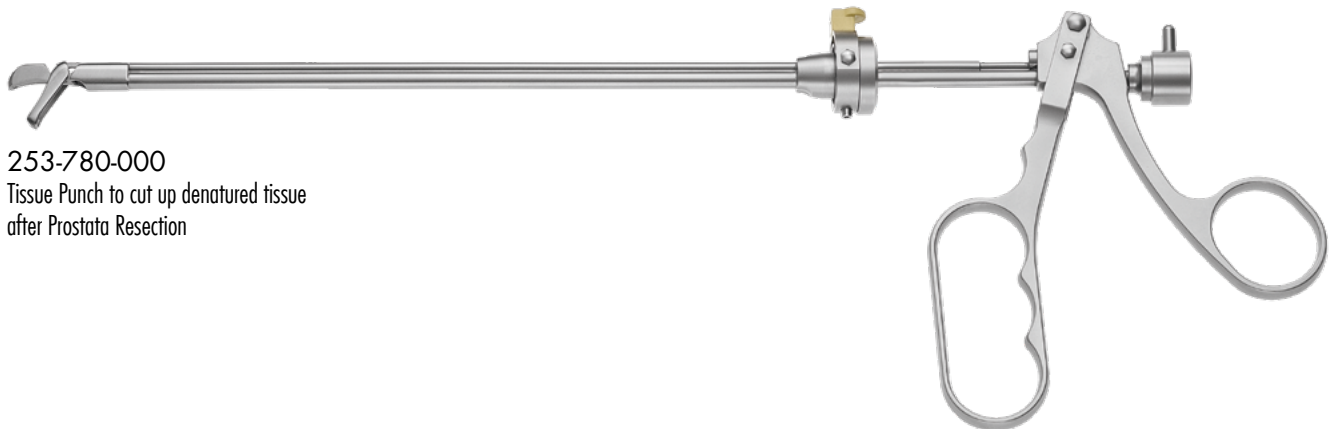

Suitable Resectoscope Sheaths
253-000-256 Rotating, 26 Charr. ●
253-000-258 Rotating, 28 Charr. ●
253-000-356 Fixed, 26 Charr. ●
253-000-358 Fixed, 28 Charr. ●



CYSTOSCOPE-URETHROSCOPE SET FOR NEW BORN

Unique 7.5 and 9 Charr. Sheath System
in atraumatic Design with 3 Charr.
Instrument Channel

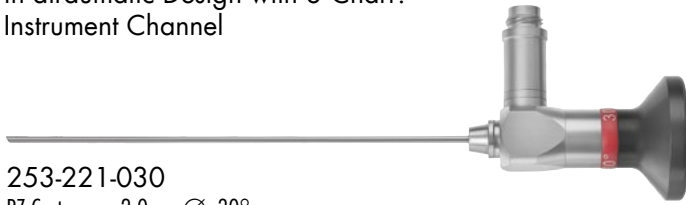

253-221-030
RZ Cystoscope 2.0mm Ø, 30°

253-221-000
RZ Cystoscope 2.0mm Ø, 0°

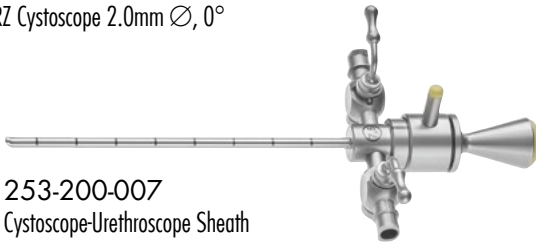

253-200-007
Cystoscope-Urethroscope Sheath
for New Born, 7.5 Charr.

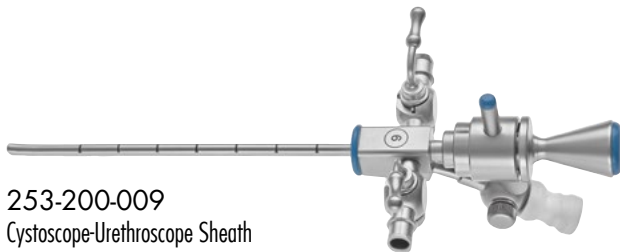

253-200-009
Cystoscope-Urethroscope Sheath
for New Born, 9 Charr.
with 3 Charr. Instrument Channel



Atraumatic Tip Design

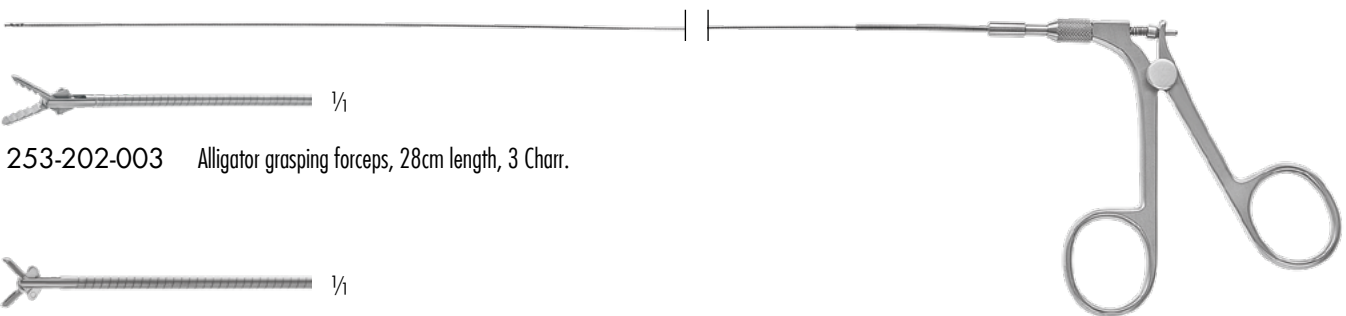

253-202-003 Alligator grasping forceps, 28cm length, 3 Charr.



253-204-003 Biopsy forceps, 28cm length, 3 Charr.



253-370-253 Ball electrode, 25cm length, 3 Charr.



253-371-253 Needle electrode, 25cm length, 3 Charr.

**4.5
Charr.**

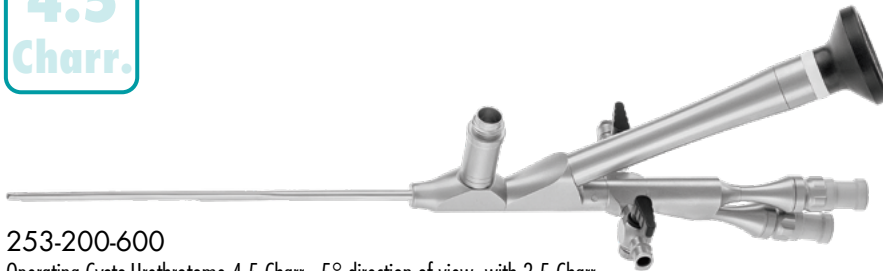

253-200-600

Operating Cysto-Urethrotome 4.5 Charr., 5° direction of view, with 3.5 Charr. working channel, 140mm working length. With 2 lateral suction-irrigation connections and 2 working channels for semi-rigid and flexible accessories.



253-905-400
Silicone Valve,
package with 5 pieces



253-900-010
Silicone Valve, package with 10 pieces,
for use with very delicate instruments
from 0.5 – 1.6mm diameter.

- Soft-Dilation Sheath 4.5 – 6.0 Charr.
- 3.5 Charr. working channel for use with 3 Charr. semi-rigid and flexible instruments and high flow irrigation
- Silicone valve for easy and safe use of all accessories
- Lightweight and “easy to handle” design
- Large variety of accessories for all kinds of pediatric urology procedures

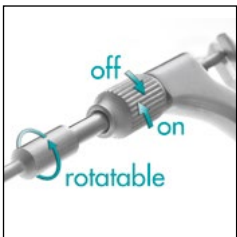
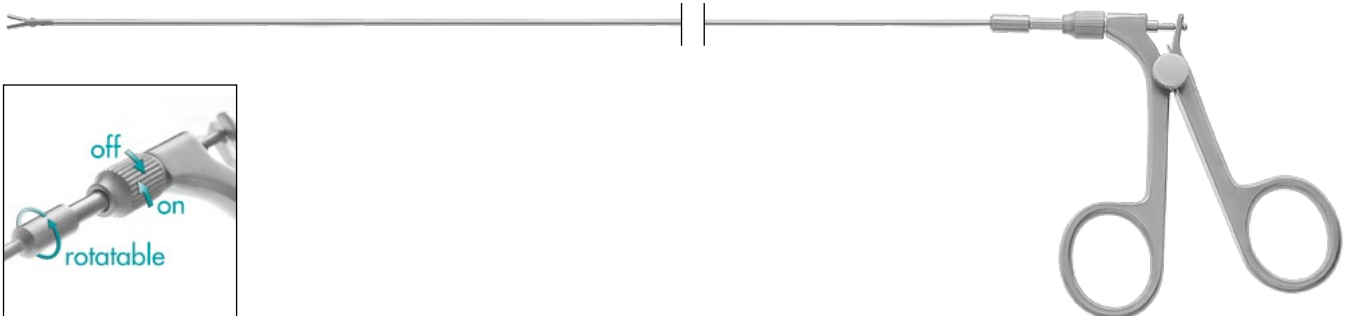

253-203-128 Stone Grasping Forceps, double action, 3 Charr., 28cm working length



253-370-253 Ball Electrode, 3 Charr., 25cm working length



253-203-228 Large Stone Grasping Forceps, double action, 3 Charr., 28cm working length



253-371-253 Needle Electrode, 3 Charr., 25cm working length



253-203-328 Biopsy Forceps, double action, 3 Charr., 28cm working length

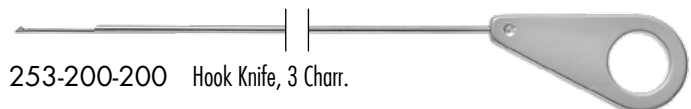

253-200-200 Hook Knife, 3 Charr.



253-203-428 Scissors, single action, 3 Charr., 28cm working length



253-200-210 Injection Cannula, 3 Charr.

**6.0
Charr.**

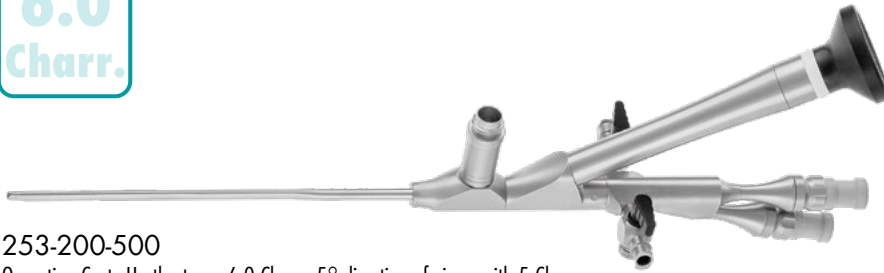

253-200-500

Operating Cysto-Urethrotome 6.0 Charr., 5° direction of view, with 5 Charr. working channel, 140mm working length. With 2 lateral suction-irrigation connections and 2 working channels for semi-rigid and flexible accessories.



253-905-400
Silicone Valve,
package with 5 pieces



253-900-010
Silicone Valve, package with 10 pieces,
for use with very delicate instruments
from 0.5 – 1.6mm diameter.

- Soft-Dilation Sheath 6.0 – 7.5 Charr.
- Large working channel for use with 4 Charr. semi-rigid and flexible instruments and high flow irrigation
- Silicone valve for easy and safe use of all accessories
- Lightweight and “easy to handle” design
- Large variety of accessories for all kinds of pediatric urology procedures

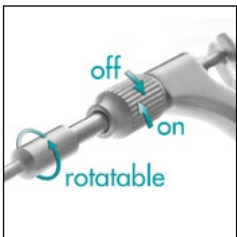
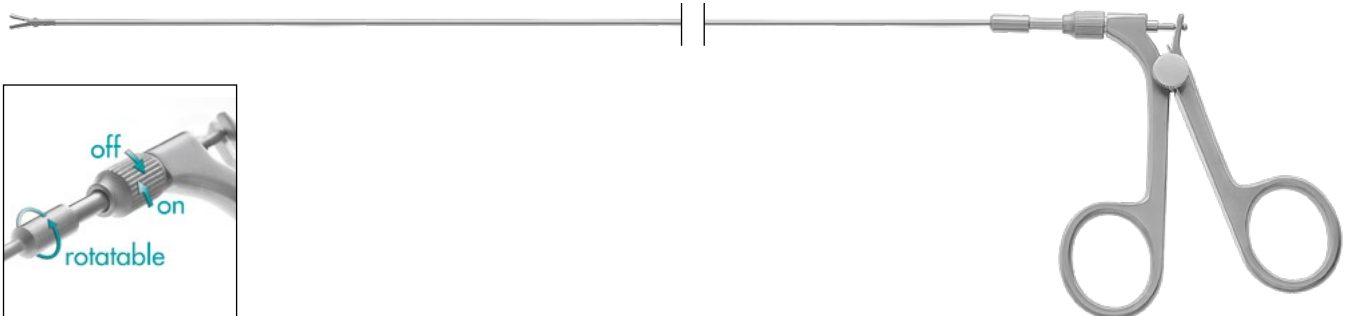

253-204-128 Stone Grasping Forceps, double action, 4 Charr., 28cm working length



253-370-253 Ball Electrode, 3 Charr., 25cm working length



253-204-228 Large Stone Grasping Forceps, double action, 4 Charr., 28cm working length



253-371-253 Needle Electrode, 3 Charr., 25cm working length



253-204-328 Biopsy Forceps, double action, 4 Charr., 28cm working length

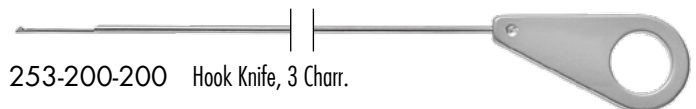

253-200-200 Hook Knife, 3 Charr.



253-204-428 Scissors, single action, 4 Charr., 28cm working length



253-200-210 Injection Cannula, 3 Charr.

**7.5
Charr.**

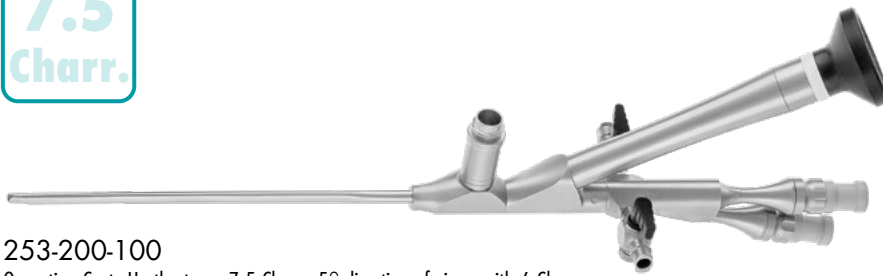

253-200-100

Operating Cysto-Urethrotome 7.5 Charr., 5° direction of view, with 6 Charr. working channel, 150mm working length. With 2 lateral suction-irrigation connections and 2 working channels for semi-rigid and flexible accessories.



253-905-400
Silicone Valve,
package with 5 pieces



253-900-010
Silicone Valve, package with 10 pieces,
for use with very delicate instruments
from 0.5 – 1.6mm diameter.

- Soft-Dilation Sheath 7.5 – 8.5 – 9.5 Charr.
- Extra large working channel for use with 5 Charr. semi-rigid and flexible instruments and high flow irrigation
- Silicone valve for easy and safe use of all accessories
- Lightweight and “easy to handle” design
- Large variety of accessories for all kinds of pediatric urology procedures



253-200-128 Stone Grasping Forceps, double action, 5 Charr.,
28cm working length



253-370-253 Ball Electrode, 3 Charr., 25cm working length



253-200-228 Large Stone Grasping Forceps, double action, 5 Charr.,
28cm working length



253-371-253 Needle Electrode, 3 Charr., 25cm working length



253-200-328 Biopsy Forceps, double action, 5 Charr.,
28cm working length

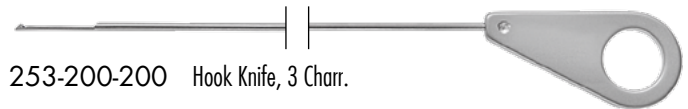

253-200-200 Hook Knife, 3 Charr.



253-200-428 Scissors, single action, 5 Charr.,
28cm working length



253-200-210 Injection Cannula, 3 Charr.

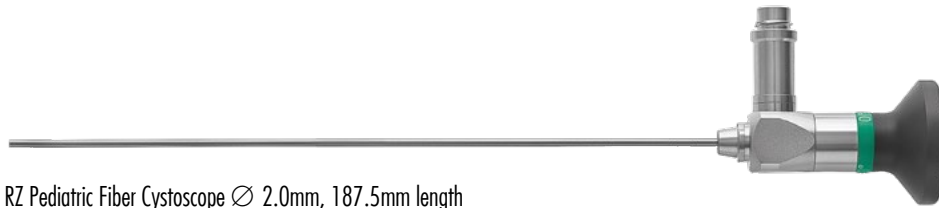

RZ Pediatric Fiber Cystoscope \varnothing 2.0mm, 187.5mm length
 253-219-100 0° direction of view,
 253-219-130 30° direction of view

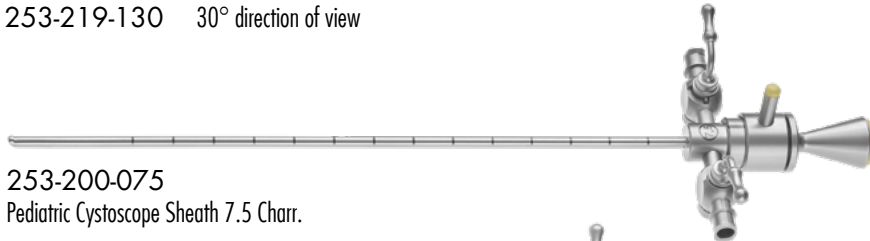

253-200-075
 Pediatric Cystoscope Sheath 7.5 Charr.

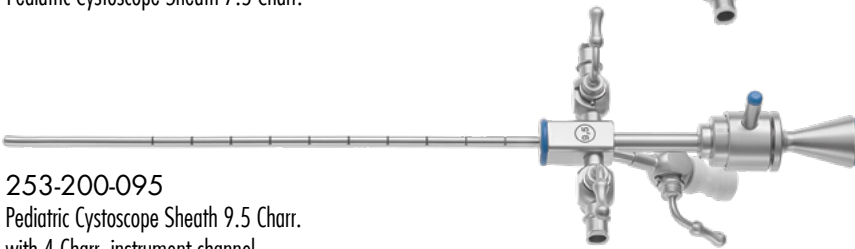

253-200-095
 Pediatric Cystoscope Sheath 9.5 Charr.
 with 4 Charr. instrument channel

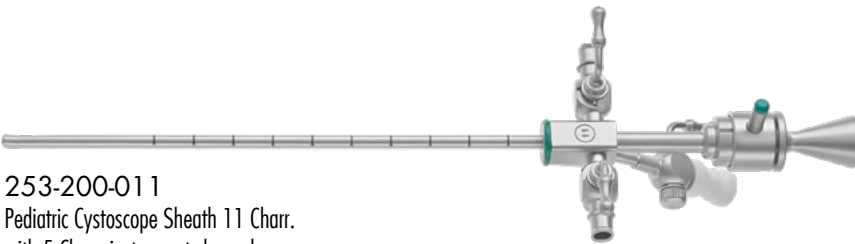

253-200-011
 Pediatric Cystoscope Sheath 11 Charr.
 with 5 Charr. instrument channel

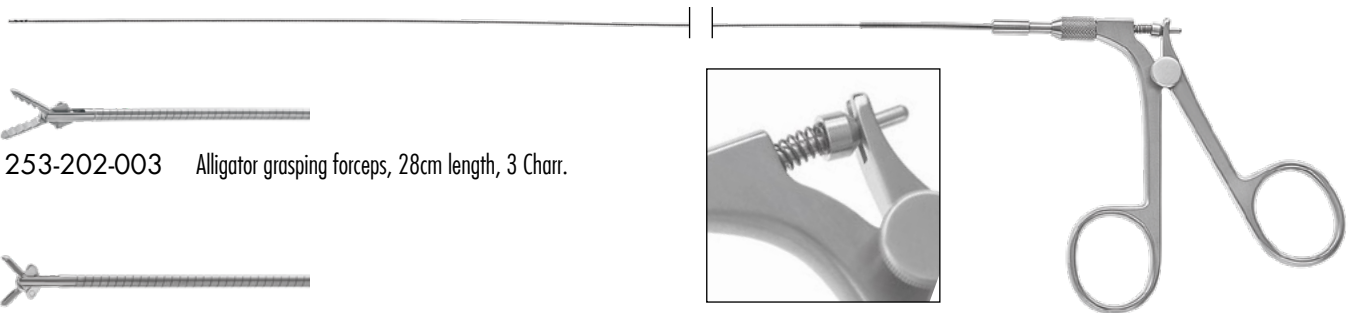

253-202-003 Alligator grasping forceps, 28cm length, 3 Charr.

253-204-003 Biopsy forceps, 28cm length, 3 Charr.

Spring Closing Mechanism



253-370-253 Ball electrode, 25cm length, 3 Charr.



253-371-253 Needle electrode, 25cm length, 3 Charr.

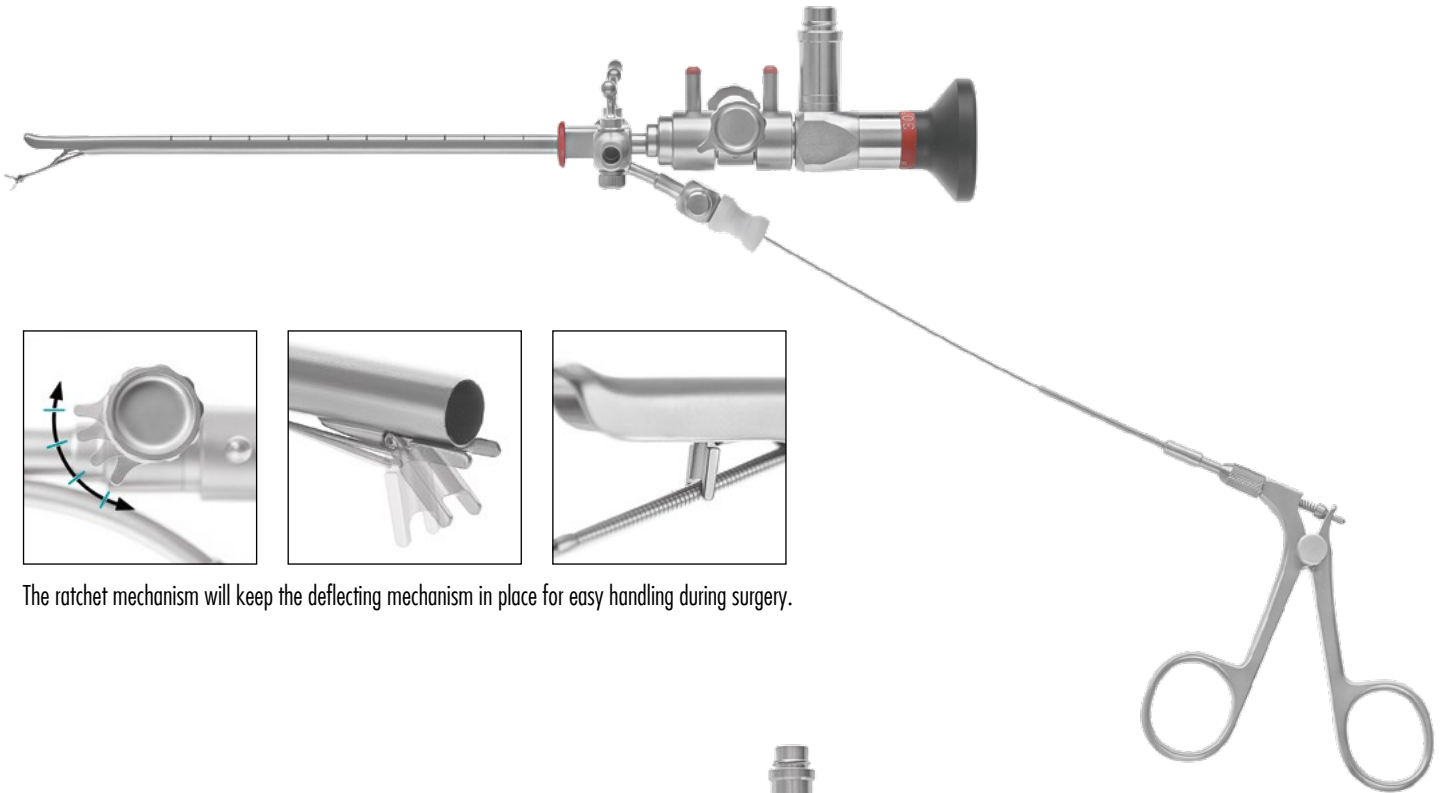

The ratchet mechanism will keep the deflecting mechanism in place for easy handling during surgery.

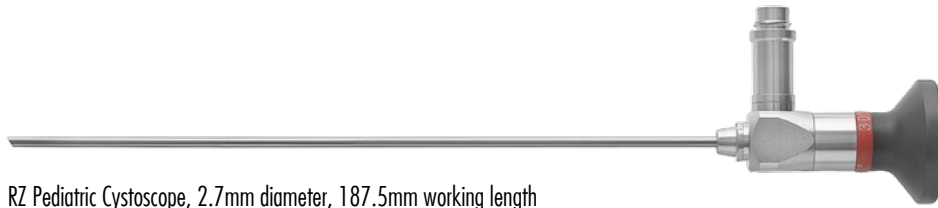

RZ Pediatric Cystoscope, 2.7mm diameter, 187.5mm working length

253-227-000 0° direction of view,

253-227-030 30° direction of view

253-227-070 70° direction of view

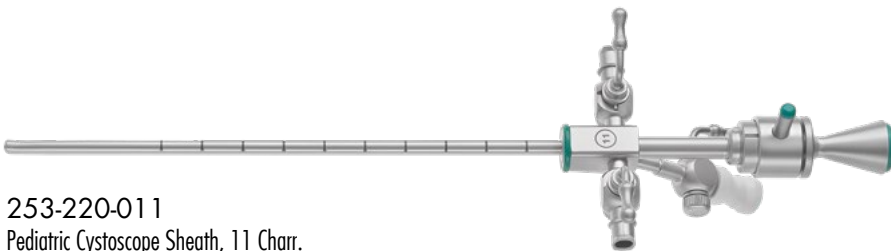

253-220-011

Pediatric Cystoscope Sheath, 11 Charr.
with 3 Charr. working channel



253-220-014
Pediatric Cystoscope Sheath 13 Charr.
with 3 Charr. working channel, for use
with Bridge or Albarran deflecting mechanism



253-220-030
Bridge for use with 253-220-014



253-220-025
Albarran deflecting mechanism for use
with 253-220-014



253-202-003 Alligator grasping forceps, 28cm length, 3 Charr.



253-204-003 Biopsy forceps, 28cm length, 3 Charr.



253-370-253 Ball electrode, 25cm length, 3 Charr.



253-371-253 Needle electrode, 25cm length, 3 Charr.

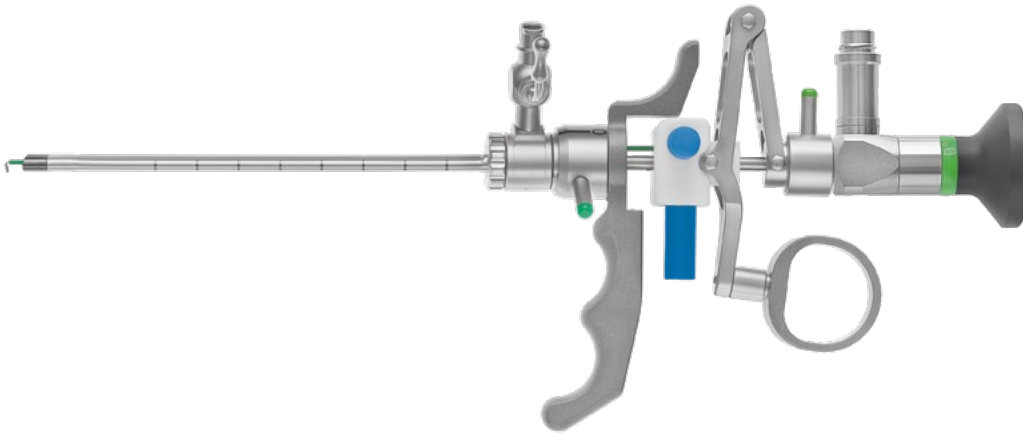

RZ-Pediatric Cystoscope 2.0mm , 187.5mm working length
 253-219-100 0° direction of view
 253-219-130 30° direction of view



253-250-200
 Passive working element for use with 2.0mm
 RZ Fiber Cystoscope 253-219-100

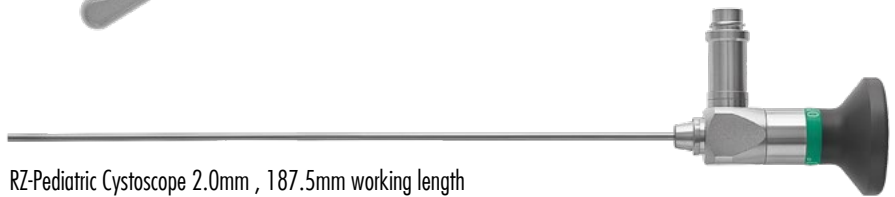

253-250-211
 Resectoscope Sheath 11 Charr.
 with obturator ●

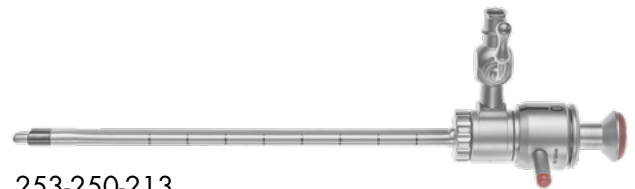

253-250-213
 Resectoscope Sheath 13 Charr.
 with obturator ●

| | | |
|--------|-------------|-------------|
| Colour | 11 Charr. ● | 13 Charr. ● |
|--------|-------------|-------------|

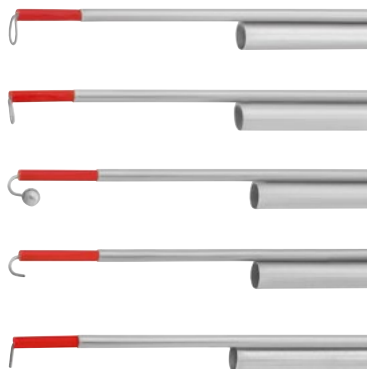

| | 11 Charr. ● | 13 Charr. ● |
|------------------------------|-------------|-------------|
| Cutting Loop | 253-251-111 | 253-252-111 |
| Coagulation Electrode, blunt | 253-251-112 | 253-252-112 |
| Hook Electrode with ball | 253-251-113 | 253-252-113 |
| Hook Electrode without ball | 253-251-114 | 253-252-114 |
| Needle Electrode, pointed | 253-251-115 | 253-252-115 |

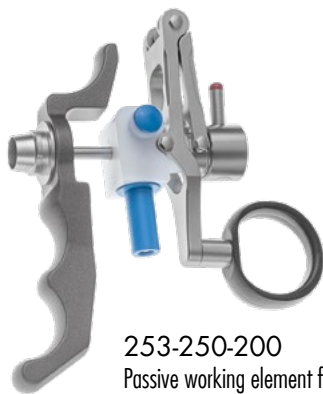
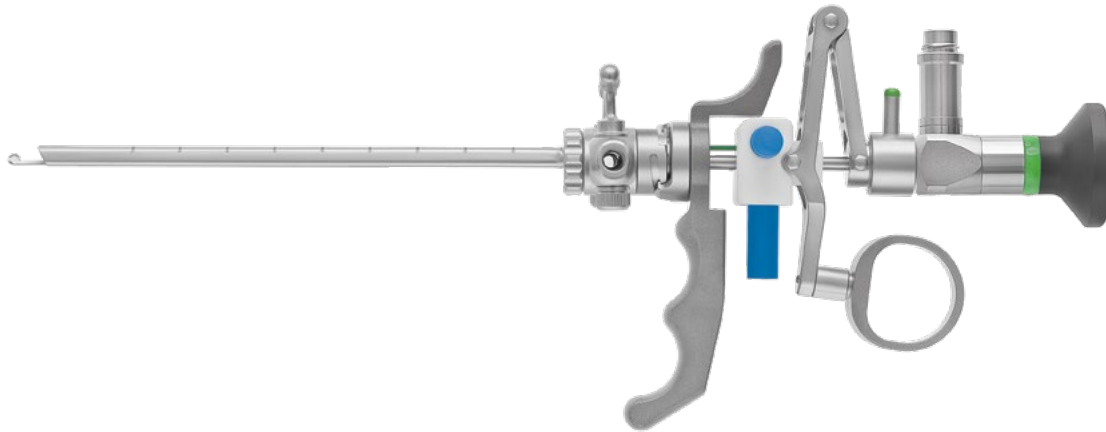

253-250-200
Passive working element for use with 2.0 mm
RZ Fiber Cystoscope 253-219-100

RZ-Pediatric Cystoscope 2.0mm , 187.5mm working length
253-219-100 0° direction of view
253-219-130 30° direction of view

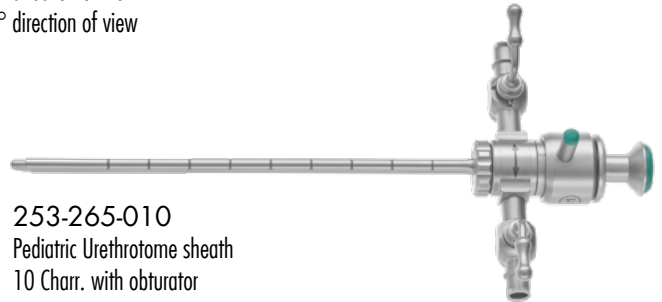
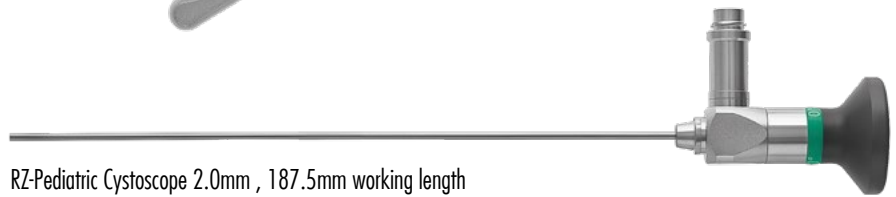

253-265-010
Pediatric Urethrotome sheath
10 Charr. with obturator

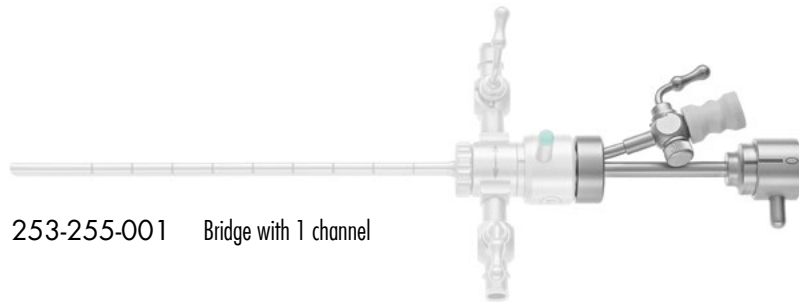

253-255-001 Bridge with 1 channel



253-265-101 Knife with straight cutting edge



253-265-102 Round knife



253-265-103 Sichel knife



253-265-104 Hook knife

RZ Cystoscope Ø 2.9mm with wide angle view, 302mm working length,
fully autoclavable, colour coded

- 253-829-000 0° direction of view
- 253-829-030 30° direction of view

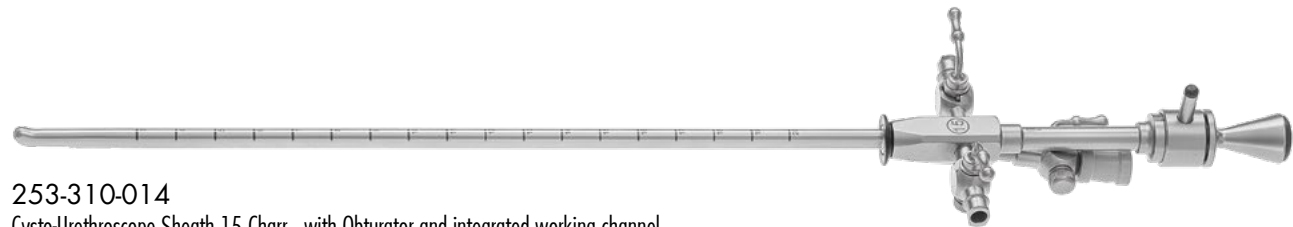

253-310-014
Cysto-Urethroscope Sheath 15 Charr., with Obturator and integrated working channel
for 5 Charr. flexible instruments and 2 lateral Luer-Lock stopcocks ○

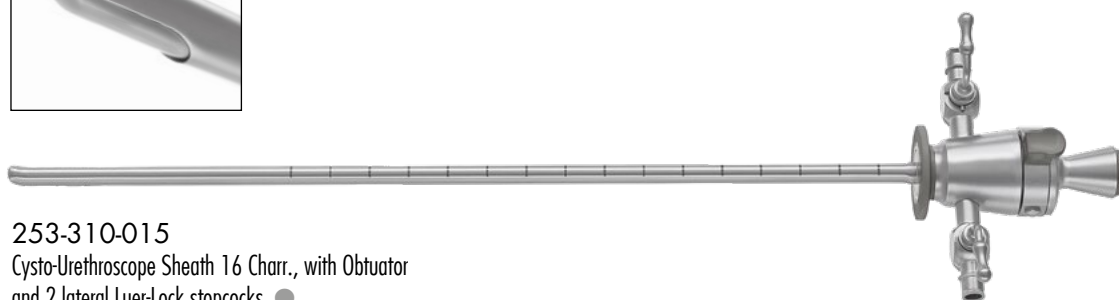

253-310-015
Cysto-Urethroscope Sheath 16 Charr., with Obturator
and 2 lateral Luer-Lock stopcocks ●

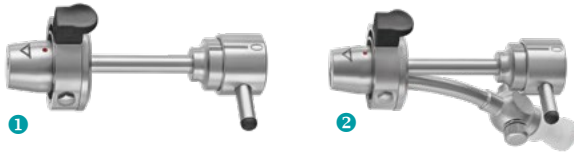

- ❶ 253-310-100 Telescope bridge without channel
- ❷ 253-310-101 Telescope bridge with 1 channel for use with 15 Charr. Adolescent Cystoscope Sheath and 5 Charr. flexible instruments



The ratchet mechanism will keep the deflecting mechanism in place for easy handling during surgery.



253-310-107
Albarran deflecting mechanism with 1 channel for 15 Charr. Adolescent Cystoscope Sheath
For use with 1 x 5 Charr. instrument

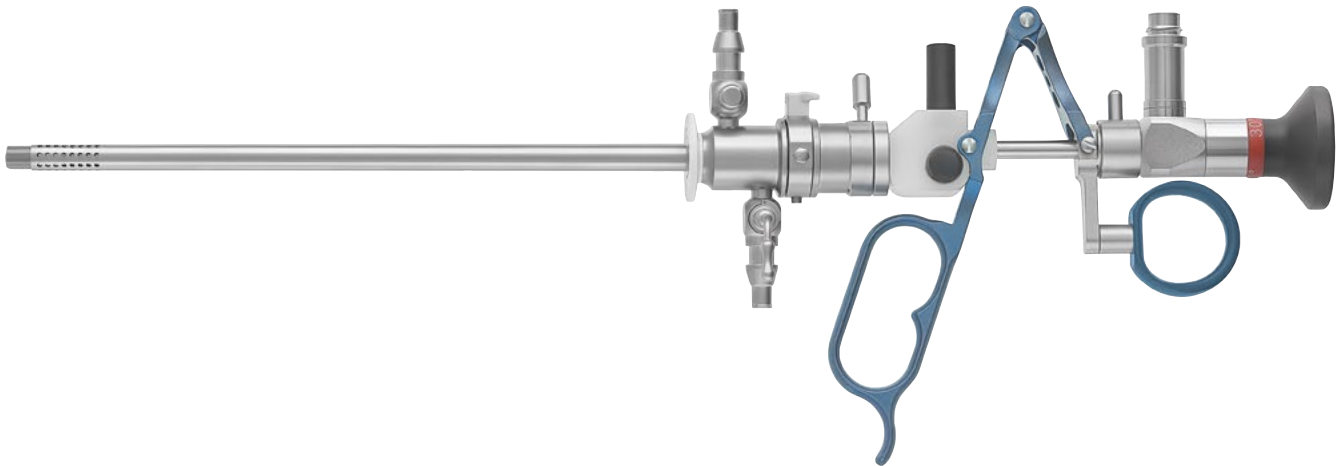

RZ Cystoscope 2.9mm with wide angle view, 302mm working length, fully autoclavable, colour coded



- 253-829-000 RZ Cystoscope, 0° direction of view
- 253-829-012 RZ Cystoscope, 12° direction of view
- 253-829-030 RZ Cystoscope, 30° direction of view

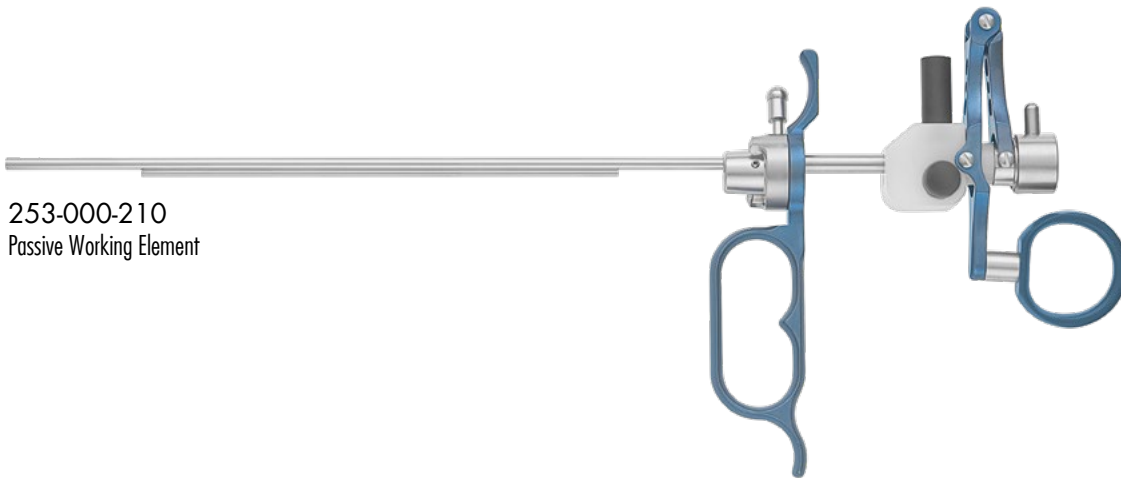

253-000-210
Passive Working Element

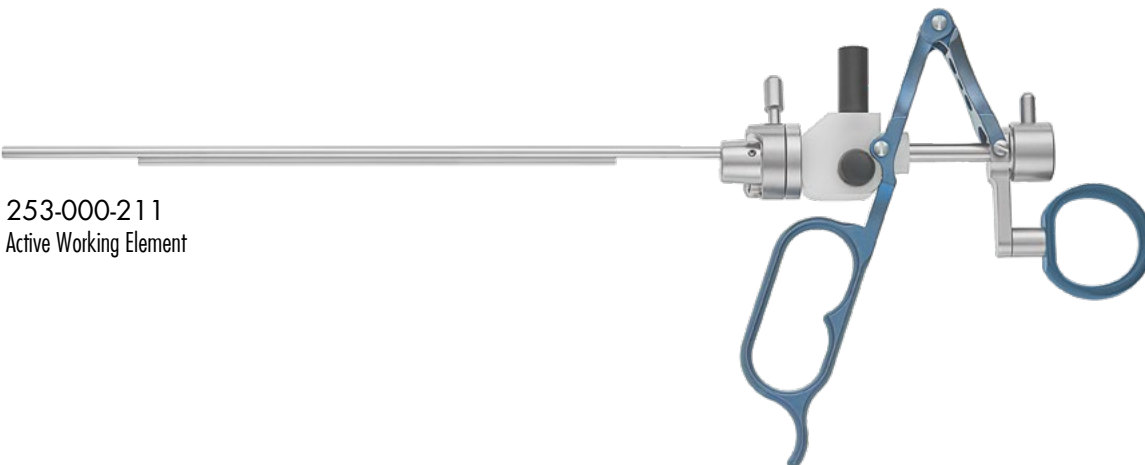

253-000-211
Active Working Element

Monopolar High Frequency cables for use with RZ Resectoscopes, 4.5m length

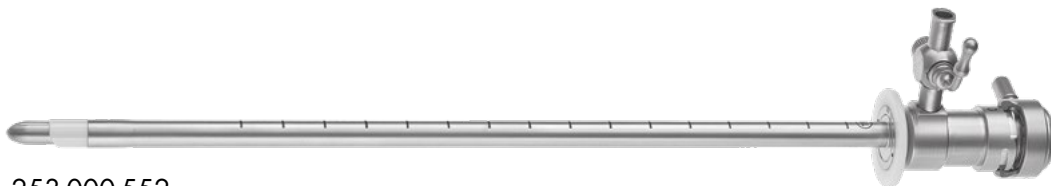
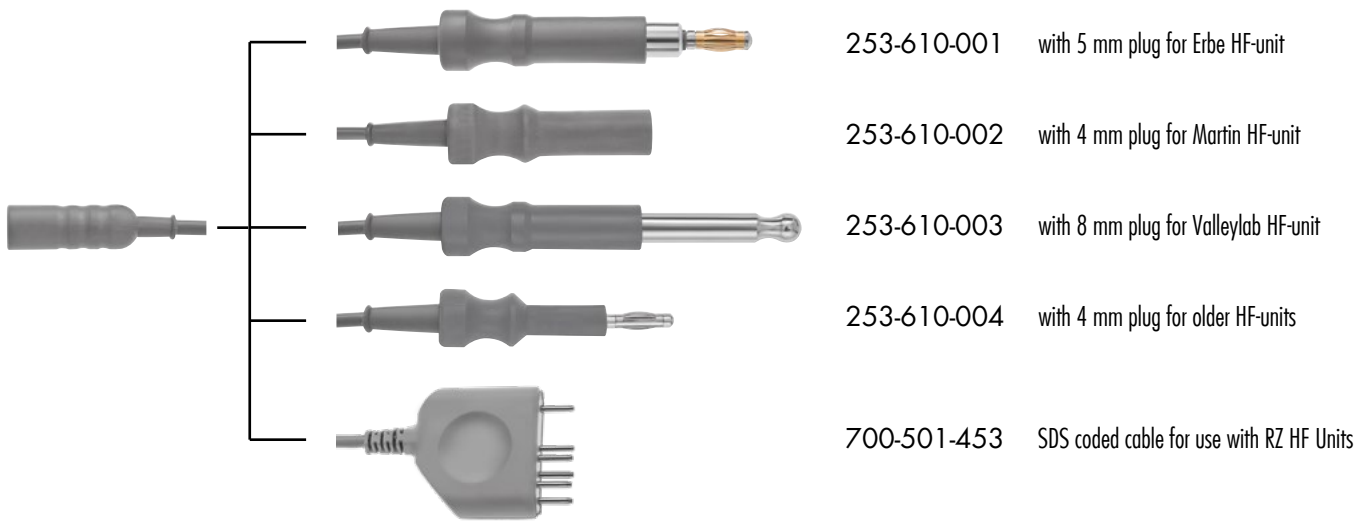

253-000-552
Standard Resectoscope Sheath for slim resectoscope, 19 Charr.

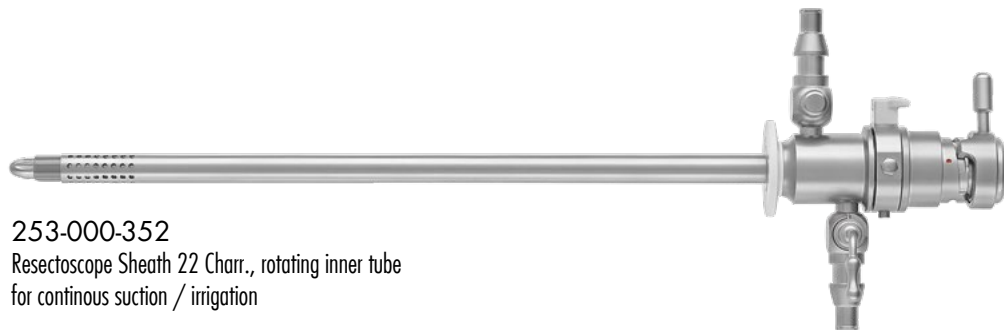

253-000-352
Resectoscope Sheath 22 Charr., rotating inner tube for continuous suction / irrigation



253-000-501 Cutting Loop, angled



253-000-502 Cutting Loop, straight



253-000-503 Coagulation Electrode, knife



253-000-505 Coagulation Electrode, ball



253-000-507 Coagulation Electrode, roller

18.5 Charr. HYBRID Resectoscope Set

Due to the coded SDS-plugs, the surgeon just needs to connect the instrument with the generator and is able to start working without preconfiguring the settings.

The RZ HYBRID Resectoscope can be used either in the monopolar or in the bipolar mode. The surgeon just needs to change the cable, the irrigation fluid (Glycine/Sorbitol (mono) or NaCl-Solution (bipo)) and connect or disconnect the neutral electrode. The Resectoscope as well as the Electrodes can be used both ways in an hybrid mode.

The 18.5 Charr. set provides all requirements and programs for doing a monopolar as well as a bipolar resection under special anatomical conditions.

HYBRID
HYBRID

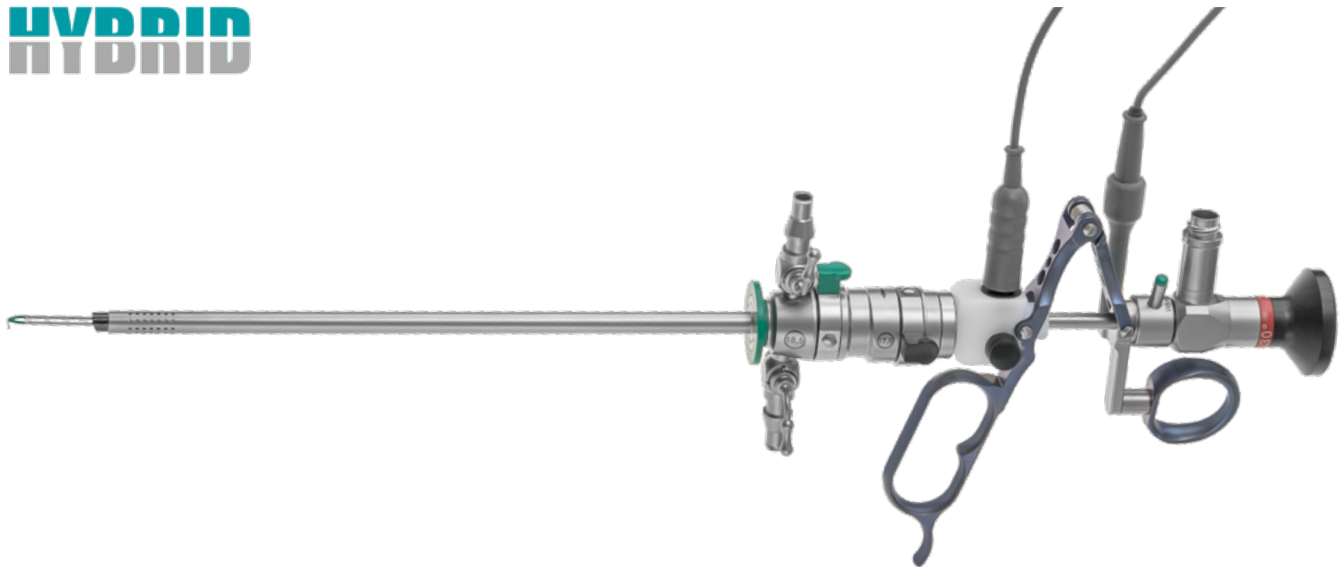

Cystoscope, Ø 2.9mm, 302mm working length, overall length: 355mm

253-829-030★ 30° direction of view
253-829-012 12° direction of view



351-400-200★
Passive Titanium Working Element



351-400-201
Active Titanium Working Element

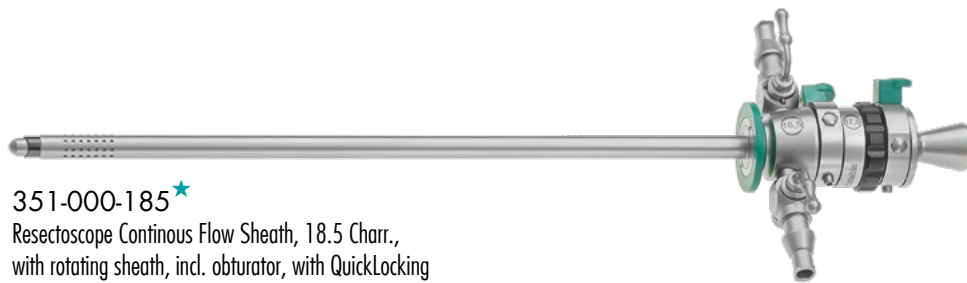

351-000-185★
Resectoscope Continuous Flow Sheath, 18.5 Charr.,
with rotating sheath, incl. obturator, with QuickLocking



351-000-180
Visual Obturator, with 5 Charr. working channel

16 Charr. Electrodes



351-000-201★

Cutting loop



351-000-202

Cutting loop, straight



351-000-203★

Knife Electrode



351-000-205★

Ball Electrode



351-000-206

Roller Electrode, 2mm

12 Charr. MINI NEPHROSCOPE

Mini PCNL: The continuous development of Nephroscopes with suitable instruments enables PCNL nowadays with working sleeves with only 15-21 Charr. The minor trauma to the kidney leads to the use of Mini-PCNL. Kidney stones will be fragmented with a pneumatic Lithotripter or laser lithotripsy system.

Due to the low-pressure suction effect around the RZ Mini Nephroscope the stone fragments will be removed with the irrigation flow. All RZ Mini Nephroscope sheaths are designed for continuous irrigation and suction.

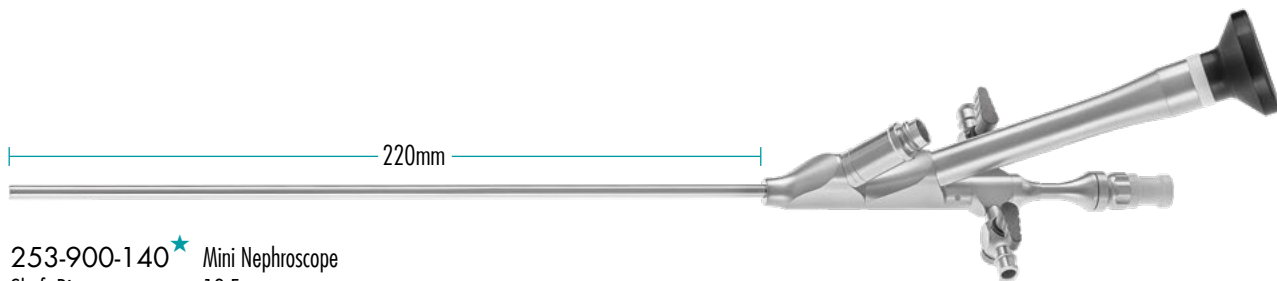

253-900-140★ Mini Nephroscope
 Shaft Diameter: 12 Fr.
 Working Channel: 7 Charr. for use with 5 Charr.RZ Instruments
 Working Length: 22cm
 Direction of view: 12°
 Pixel: 40.000



253-905-400
 Silicone Valve,
 package with 5 pieces



253-900-010
 Silicone Valve, package with 10 pieces,
 for use with very delicate instruments
 from 0.5 – 1.6mm diameter.

OPERATING SHEATHS for use with RZ Mini Nephroscope

15.0 Charr. ●



253-900-141 ★

15.0 Charr. Nephroscope Sheath for Pediatric use or additional sheath in a multitract PCNL



253-900-171

15.0 Charr. Nephroscope Sheath

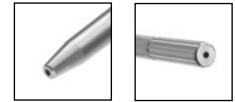

253-900-146 ★

One-Step Dilator with 1 central guide wire channel for 253-900-141



253-900-145 ★

2-piece Sealing Adapter with sheath and obturator for use with 253-900-141

16.5 Charr. ●



253-900-142 ★

16.5 Charr. Nephroscope Sheath for standard procedures



253-900-175

16.5 Charr. Nephroscope Sheath

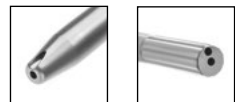

253-900-147 ★

One-Step Dilator with 1 central guide wire channel and 1 excentric guide wire channel for 253-900-142

21.0 Charr. ●



253-900-143 ★

21.0 Charr. Nephroscope Sheath for lower calyx access



253-900-173

21.0 Charr. Nephroscope Sheath

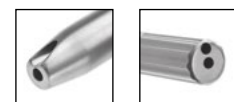

253-900-148 ★

One-Step Dilator with 1 central guide wire channel and 1 excentric guide wire channel for 253-900-143

RZ NEPHROSCOPY INSTRUMENTS

450mm working length, semi-rigid, 5 Charr.

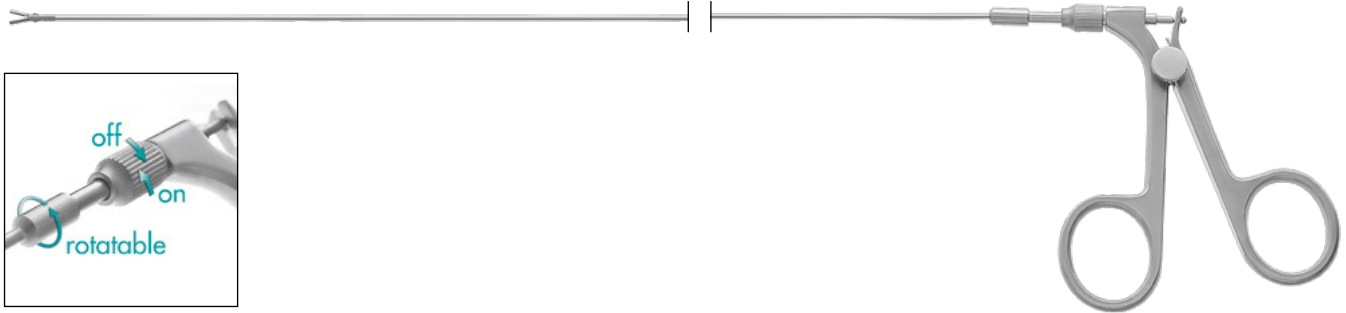

Stone Grasping Forceps
Double action jaws, retrograde serration

253-950-455★



Stone Grasping Forceps
For large stones, double action jaws, 1 x 1 teeth

253-952-455★



Hamada Long Stone Grasping Forceps
Double action jaws, fine serrated

253-954-455



Biopsy Forceps
Double action jaws

253-956-455★



Scissors
Single action jaws

253-958-455

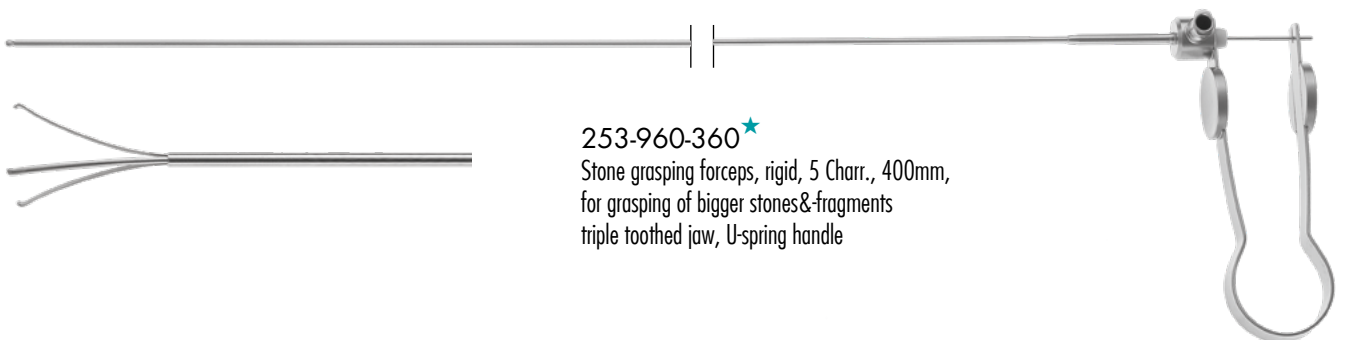

253-960-360★
Stone grasping forceps, rigid, 5 Charr., 400mm,
for grasping of bigger stones&-fragments
triple toothed jaw, U-spring handle

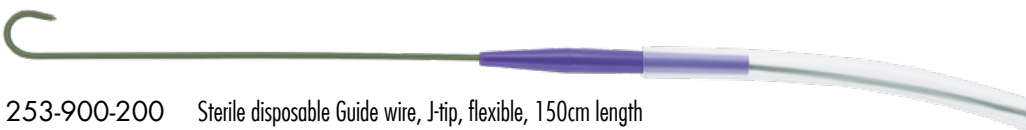

253-900-200 Sterile disposable Guide wire, J-tip, flexible, 150cm length



Features:

- a delicate sheath but with the advantage of a robust design
- an oval outer tube but with a round working channel
- a new \varnothing 1.8mm (5.4 Charr.) rod lens system to achieve finest image quality
- By using our
 - continuous-flow-system
 - swivel irrigation ring on the sheath and
 - the automatic valve,
 we introduce you to our user-friendly instruments.
- Extended working length (220mm) to be used in bariatric surgery.
- The direction of view of 15° or 30° allows you a field of view of 80° .
- We ensure the use of our common standard instruments in connection with our Compact Nephroscope up to 12 Charr. / \varnothing 4.0mm. For example, you can use: ultrasound probes, lithoclast, electrohydraulic litho-tripsy and mechanical instruments.

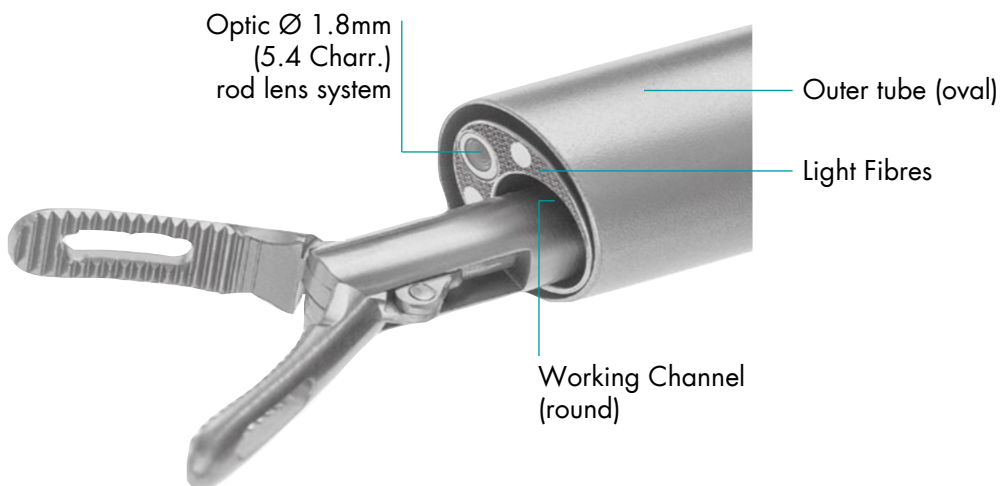

220mm working length, 80° field of view



253-900-000
Irrigation-Valve-Adapter for Compact Nephroscope

Light port adapter, 78° angled,
compatible with
ACMI •
Wolf •
Storz/Olympus •

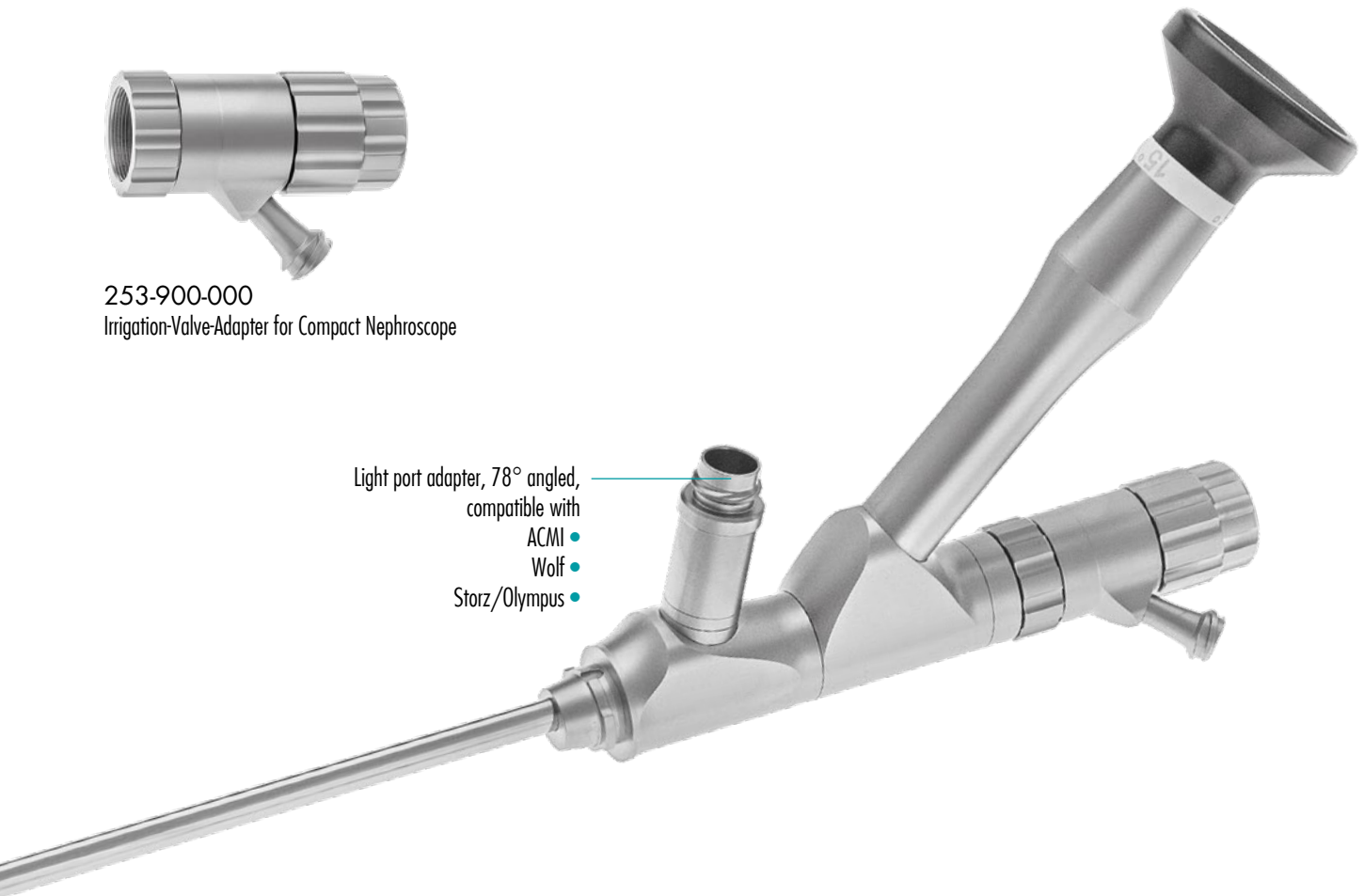

Compact Nephroscope, including Irrigation-Valve-Adapter 253-900-000

| Outer tube (oval) | Working channel (round) | Direction of view | Order No. |
|-------------------------|-------------------------|-------------------|-------------|
| Length | | | |
| 18.8 Charr. (6.3 mm) | 12.9 Charr. (4.3 mm) | 15° | 253-900-815 |
| | | 30° | 253-900-830 |

SUITABLE SHAFT (with obturator, 220mm working length)

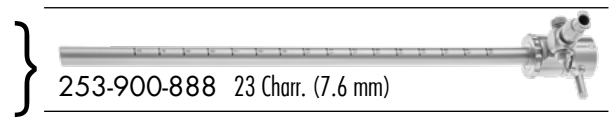

* on request

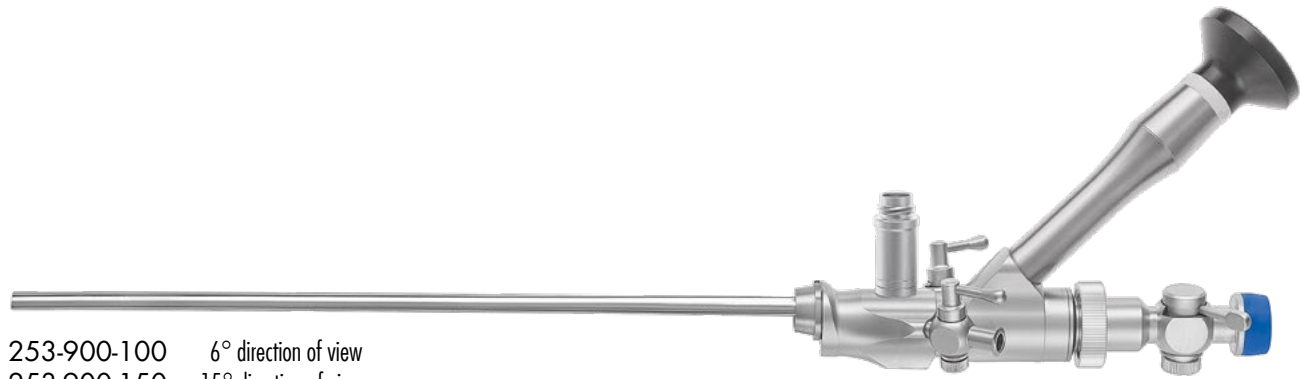

253-900-100 6° direction of view
 253-900-150 15° direction of view
 RZ Nephroscope, oblique view, with 2 Luer-Lock stopcocks and detachable instrument stopcock



253-900-105
 Stopcock, only for use with RZ Nephroscopes
 (including: 253-900-100 and 253-900-101)

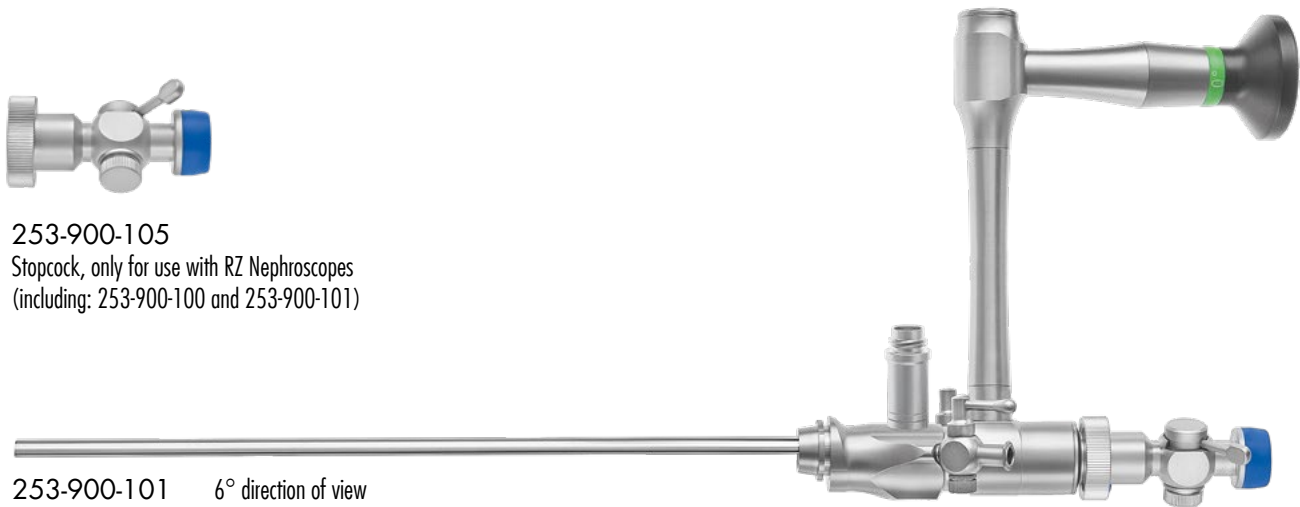

253-900-101 6° direction of view
 253-900-151 15° direction of view
 RZ Nephroscope, parallel view, with 2 Luer-Lock stopcocks and detachable instrument Stopcock

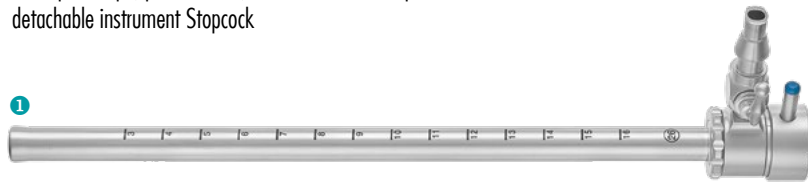

① 253-900-110 ★ Operating Sheath 26 Charr.
 ② 253-900-111 Operating Sheath 24 Charr.



① 253-900-115 ★ Hollow Obturator 26 Charr.
 ② 253-900-116 Hollow Obturator 24 Charr.



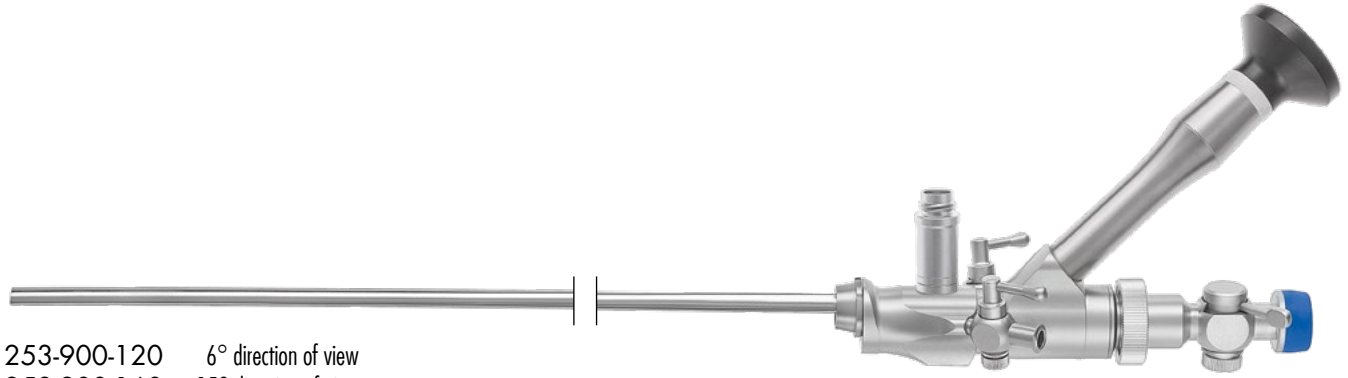

253-900-120 6° direction of view
 253-900-160 15° direction of view
 RZ Nephroscope, oblique view, with 2 Luer-Lock stopcocks and detachable instrument stopcock,
 25cm / 10" working length



253-900-105
 Stopcock, only for use with RZ Nephrosopes

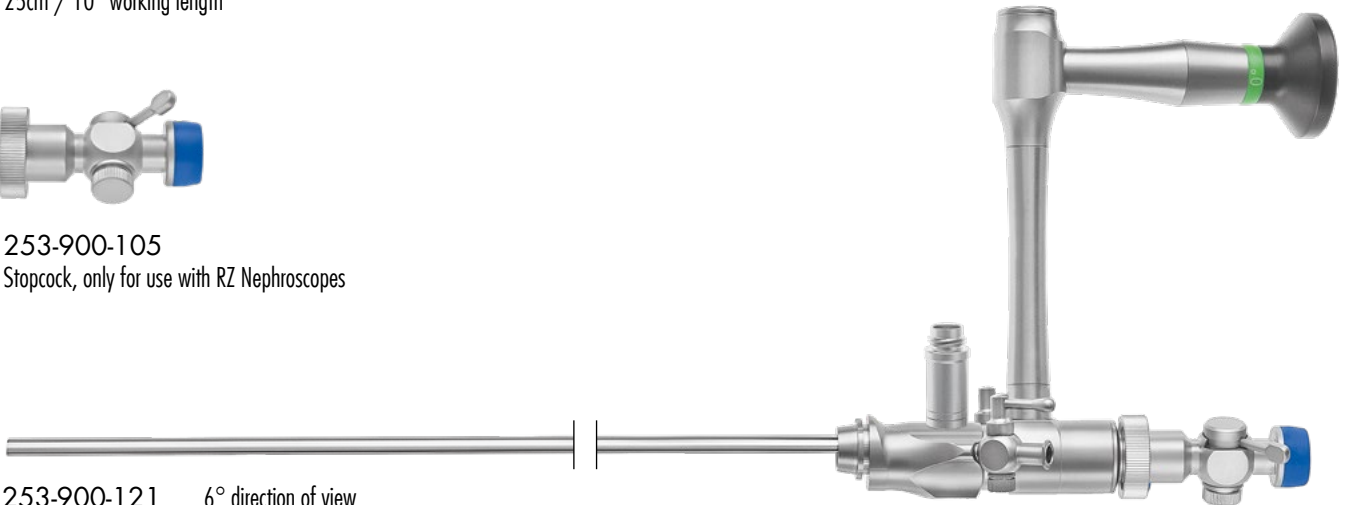

253-900-121 6° direction of view
 253-900-161 15° direction of view
 Nephroscope Scope, oval instrument channel, parallel eye piece, 250mm working length



① 253-900-130 ★ Operating Sheath 26 Charr.
 ② 253-900-131 Operating Sheath 24 Charr.

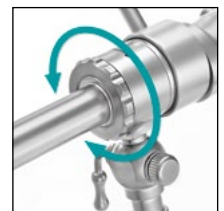

① 253-900-135 ★ Hollow Obturator 26 Charr.
 ② 253-900-136 Hollow Obturator 24 Charr.



253-900-155★

Amplatz metal Dilator Set containing 6 Dilators with 9, 12, 15, 18, 21 and 24 Charr. and 2 flexible and 2 rigid guide rods for use with guide wires

600-662-077



253-900-156★

Amplatz metal Dilator 27 Charr.



253-900-157★

Amplatz metal Dilator 30 Charr.



253-900-201★

Puncture Cannula with inner and outer cannula



253-900-202★

Dilation Cannula, 3mm \varnothing with inner and outer cannula



253-900-200

Sterile disposable Guide wire, J-tip, flexible, 150cm length



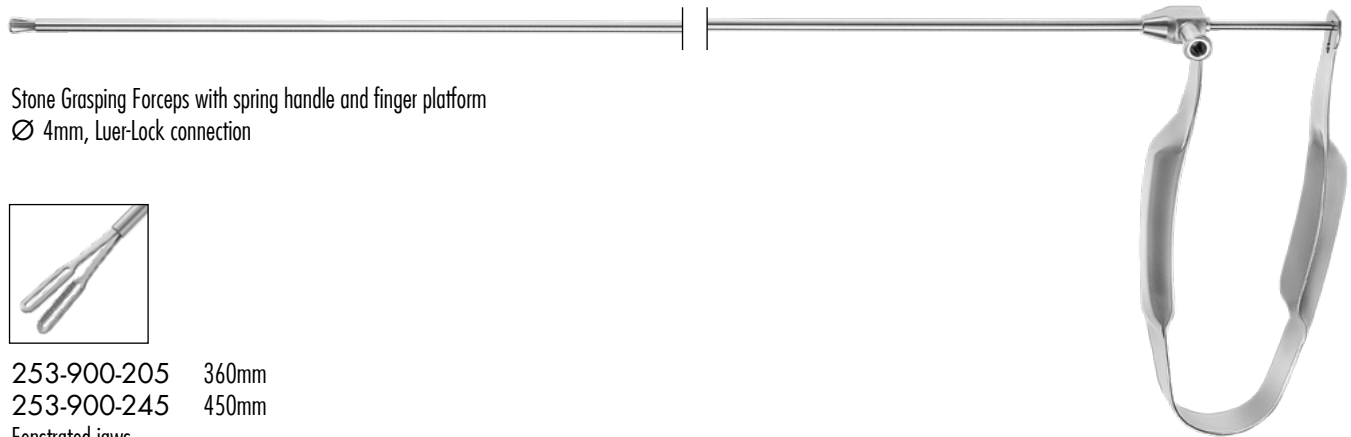

Stone Grasping Forceps with spring handle and finger platform
 Ø 4mm, Luer-Lock connection



253-900-205 360mm
 253-900-245 450mm
 Fenestrated jaws



253-900-206 360mm
 253-900-246 450mm
 3 prongs

Knives, with three-ring-handle, 10.5Charr., 360mm length

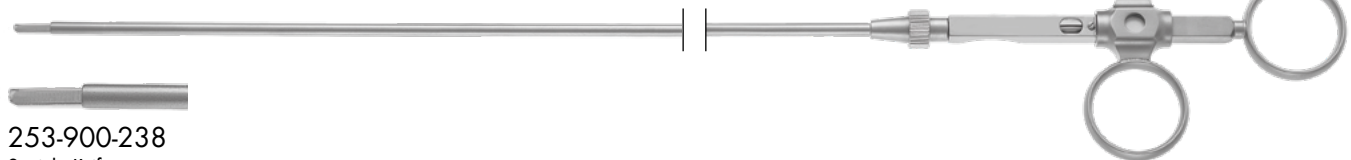

253-900-238
 Straight Knife



253-900-239
 Sickle Knife

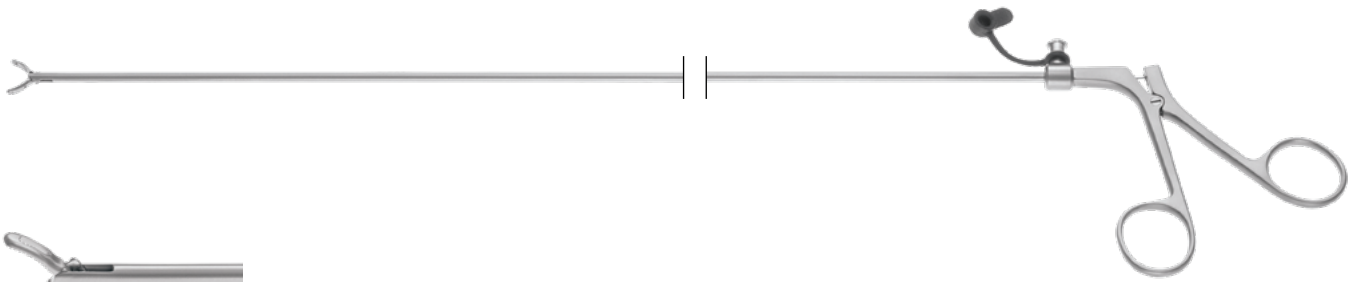

Stone Grasping forceps with fenestrated jaws, double action, ring handle, with flushing port

253-900-210  360mm working length

253-900-250  430mm working length



Stone Grasping forceps with coarse serrated jaws, double action, ring handle, with flushing port

253-900-212  360mm working length

253-900-252  430mm working length



Biopsy forceps with sharp cup, single action, ring handle, with flushing port

253-900-211 360mm working length

253-900-251 430mm working length



Scissors, sharp tip, single action, ring handle, with flushing port

253-900-213 360mm working length

253-900-253 430mm working length



URETERO-RENSCOPY

Flexible
Uretero-Renoscope

253-800-900
Flexible Uretero-Renoscope

Shaft size: 7.5 Charr.
Working Channel: \varnothing 3.6 Charr.
Angulation up/down: 275°/275°
Working length: 680mm



Shaft size: 7.5 Charr.
Slimline sheath for
easy insertion

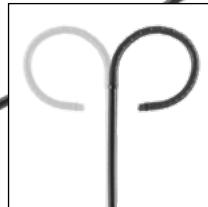

Angulation:
275° / 275°



3.6 Charr. working
channel



Ergonomic grip

Stone Baskets, tipless, ball shape, 120cm length, \varnothing 12mm, nitinol,
sterile, single use

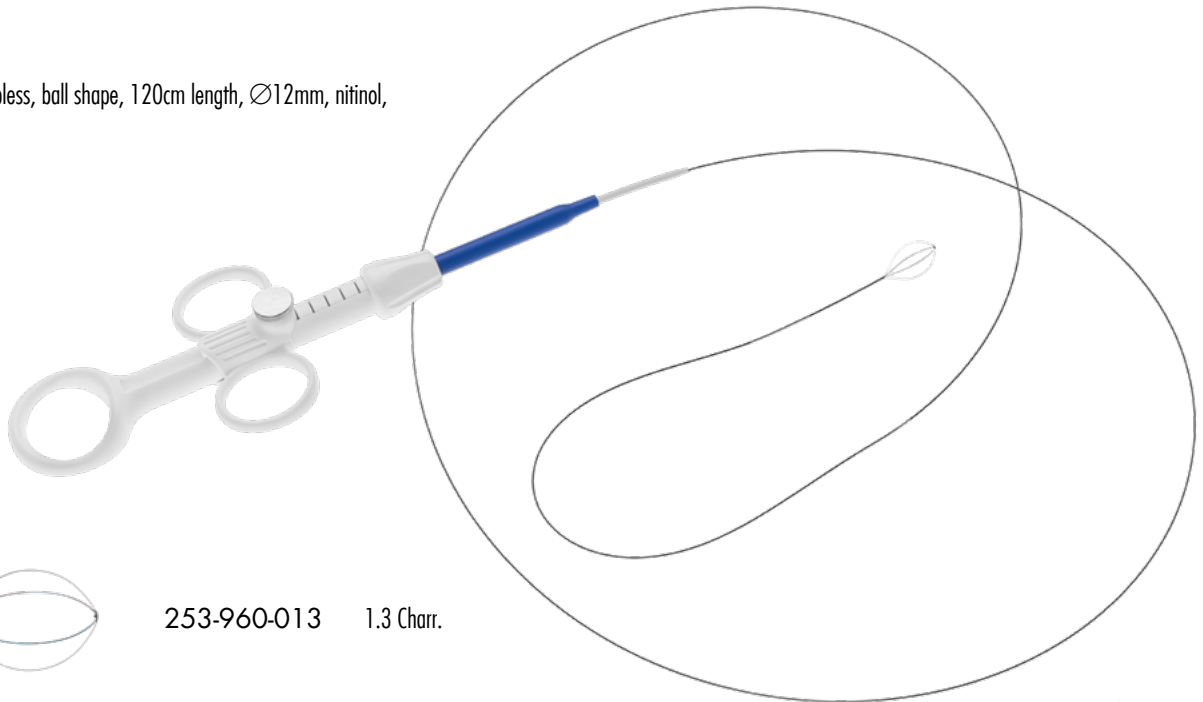

253-960-013 1.3 Charr.



253-960-019 1.9 Charr.

RZ Uretero-Renoscopes



50.000 Pixel Fiber System



Atraumatic Tip Design

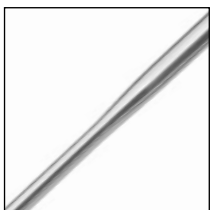

Tapered shaft

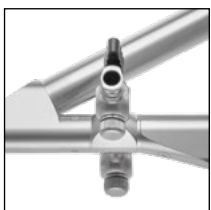

Straight channels/connectors

Features and benefits:

- Full HD 50.000 Pixel Fiber System for brilliant picture quality
- Semi-flexible shaft for operations in difficult to access areas
- Atraumatic Tip Design for easy introduction into the ureteral orifice
- Soft-step tapered shaft for atraumatic dilation of the ureter
- Silicone valve system with 2 parallel sealings for leaking-free working channels
- 2 different working lengths, suitable for upper and lower ureter-renaloscopies
- Large working channels for use with all necessary accessories and instruments
- Irrigation/suction channels for better dilation and continuous suction
- Straight light connector and channels for ergonomic handling





Advanced Semi-Rigid Uretero-Renoscope

253-905-540★ 425mm
253-905-530 310mm

- Full HD 50.000 Pixel Fiber System for brilliant picture quality
- Semi-flexible shaft for operations in difficult to access areas
- Atraumatic tip design for easy introduction into the ureteral orifice
- Soft-step tapered shaft for atraumatic dilation of the ureter
- Silicone valve system with 2 parallel sealings for leaking-free working channels
- Large working channels for use with all necessary accessories and instruments
- Oblique irrigation/suction channels for better dilation and continuous suction, increases vision during bleedings

Shaft Diameter / Length

| | |
|--|----------------|
| Distal Tip | 7.0 Charr. |
| Distal | 8.0 Charr. |
| Proximal | 9.5 Charr. |
| Total Working Length | 425mm or 310mm |
| Working Channel | 5.8 Charr. |
| <small>(for use with instruments up to 5 Charr.)</small> | |
| Field of view | 65° |
| Direction of View | 5° |



90° stopcocks for more space and better position

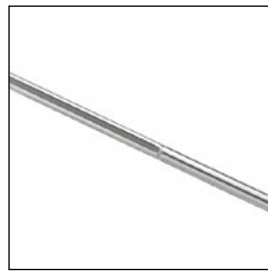

The innovative semi-rigid designed one-piece tapered shaft allows easy insertion and gentle dilation.



New sealing system to stop water escape



Atraumatic tip design

Accessories



253-905-400
Silicone Valve,
package with 5 pieces



253-900-010
Silicone Valve, package with 10 pieces,
for use with very delicate instruments
from 0.5 – 1.6mm diameter.



600-662-077
Endoscopic wire basket for URS
640 x 150 x 77mm



253-905-000
Container for URS with silicone inserts
640 x 140 x 60mm









253-900-001
Uretero-Renoscope carrying case



- Ergonomic handle design enables effortless working
- The finger rest simplifies control of the instrument
- With integrated, automatic closing system**
- Bending of the instrument is avoided while using it in combination with a sheath resulting through a lightweight handle
- Lotus-effect of the surface enables an increase of lifetime
- 360° rotating mechanism allows an optimal position of the jaw



■ Knob color

| | | 5 Charr. | 4 Charr. | |
|--|----------|--------------|--------------|--|
|  ** | rigid | 253-950-005★ | 253-950-004★ | Stone Grasping Forceps, double action jaws, 60cm length |
| | flexible | 253-951-005 | 253-951-004 | |
|  ** | rigid | 253-952-005★ | 253-952-004★ | Stone Grasping Forceps for large stones, double action jaws, 60cm length |
| | flexible | 253-953-005 | 253-953-004 | |
|  ** | rigid | 253-954-005★ | 253-954-004★ | HAMADA long Stone Grasping Forceps, double action jaws, 60cm length |
| | flexible | 253-955-005 | 253-955-004 | |
|  ** | rigid | 253-956-005★ | 253-956-004★ | Biopsy Forceps, double action jaws, 60cm length |
| | flexible | 253-957-005 | 253-957-004 | |
|  ** | rigid | 253-958-005★ | 253-958-004★ | Scissors, single action, 60cm length |
| | flexible | 253-959-005 | 253-959-004 | |

 253-960-025 Stone Basket, 2.5 Charr., sterile single use, package of 5 pieces *

 253-962-003 Brush for Cytology, 3.0 Charr., for single use, package of 5 pieces *

 253-940-005 3-Prongs Grasper, flexible, 600mm working length, 5 Charr.

 253-585-005 Dormia Metal Stone Basket, flexible, 4 wires, 600mm working length, 5 Charr.



253-910-540★ 425mm
253-910-530 310mm

slim

- Full HD 40.000 Pixel Fiber System for brilliant picture quality
- Semi-flexible shaft for operations in difficult to access areas
- Atraumatic tip design for easy introduction into the ureteral orifice
- Soft-step tapered shaft for atraumatic dilation of the ureter
- Silicone valve system with 2 parallel sealings for leaking-free working channels
- Large working channels for use with all necessary accessories and instruments
- Oblique irrigation/suction channels for better dilation and continuous suction, increases vision during bleedings

| Shaft Diameter / Length | |
|--|----------------|
| Distal Tip | 6.0 Charr. |
| Distal | 7.0 Charr. |
| Proximal | 7.5 Charr. |
| Total Working Length | 425mm or 310mm |
| Working Channel | 5 Charr. |
| <small>(for use with instruments up to 4 Charr.)</small> | |
| Field of view | 65° |
| Direction of View | 5° |



253-905-400
Silicone Valve,
package with 5 pieces



253-900-010
Silicone Valve, package with 10 pieces,
for use with very delicate instruments
from 0.5 – 1.6mm diameter.

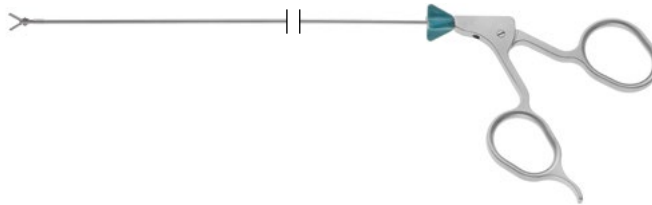

4 Charr. Instruments



| | | |
|----------|-------------|--|
| rigid | 253-950-004 | Stone Grasping Forceps, double action jaws, 60cm length |
| flexible | 253-951-004 | |

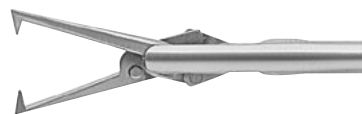

| | | |
|----------|-------------|--|
| rigid | 253-952-004 | Stone Grasping Forceps for large stones, double action jaws, 60cm length |
| flexible | 253-953-004 | |



| | | |
|----------|-------------|---|
| rigid | 253-954-004 | HAMADA long Stone Grasping Forceps, double action jaws, 60cm length |
| flexible | 253-955-004 | |



| | | |
|----------|-------------|--|
| rigid | 253-956-004 | Biopsy Forceps, double action jaws, 60cm length |
| flexible | 253-957-004 | |



| | | |
|----------|-------------|--------------------------------------|
| rigid | 253-958-004 | Scissors, single action, 60cm length |
| flexible | 253-959-004 | |



253-915-540★ 425mm
253-915-530 310mm

superslim

- Full HD 30.000 Pixel Fiber System for brilliant picture quality
- Semi-flexible shaft for operations in difficult to access areas
- Atraumatic tip design for easy introduction into the ureteral orifice
- Soft-step tapered shaft for atraumatic dilation of the ureter
- Silicone valve system with 2 parallel sealings for leaking-free working channels
- Large working channels for use with all necessary accessories and instruments
- Oblique irrigation/suction channels for better dilation and continuous suction, increases vision during bleedings

Shaft Diameter / Length

| | |
|--|----------------|
| Distal Tip | 4.5 Charr. |
| Distal | 5.0 Charr. |
| Proximal | 6.0 Charr. |
| Total Working Length | 425mm or 310mm |
| Working Channel | 4 Charr. |
| <small>(for use with instruments up to 3 Charr.)</small> | |
| Field of view | 65° |
| Direction of View | 5° |



253-905-400
Silicone Valve,
package with 5 pieces



253-900-010
Silicone Valve, package with 10 pieces,
for use with very delicate instruments
from 0.5 – 1.6mm diameter.

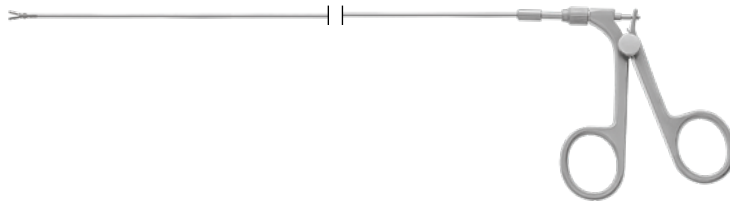

3 Charr. Instruments



| | | |
|----------|-------------|--|
| rigid | 253-950-003 | Stone Grasping Forceps, double action jaws, 60cm length |
| flexible | 253-951-003 | |



| | | |
|----------|-------------|--|
| rigid | 253-952-003 | Stone Grasping Forceps for large stones, double action jaws, 60cm length |
| flexible | 253-953-003 | |



| | | |
|----------|-------------|---|
| rigid | 253-954-003 | HAMADA long Stone Grasping Forceps, double action jaws, 60cm length |
| flexible | 253-955-003 | |



| | | |
|----------|-------------|--|
| rigid | 253-956-003 | Biopsy Forceps, double action jaws, 60cm length |
| flexible | 253-957-003 | |



| | | |
|----------|-------------|--------------------------------------|
| rigid | 253-958-003 | Scissors, single action, 60cm length |
| flexible | 253-959-003 | |

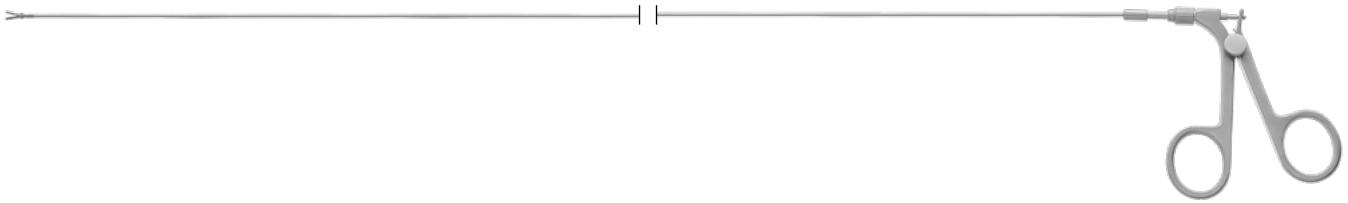

4 Charr. Instruments



| | | |
|------------|-------------|--|
| semi-rigid | 253-944-004 | Fenestrated Grasping Forceps, double action jaws, 60cm length |
| flexible | 253-945-004 | |

5 Charr. Instruments



| | | |
|------------|-------------|--|
| semi-rigid | 253-944-005 | Fenestrated Grasping Forceps, double action jaws, 60cm length |
| flexible | 253-945-005 | |

All RZ syringes are provided with the Turn Lock connection for fast, easy and safe connection to all RZ Cystoscope and Resectoscope sheaths

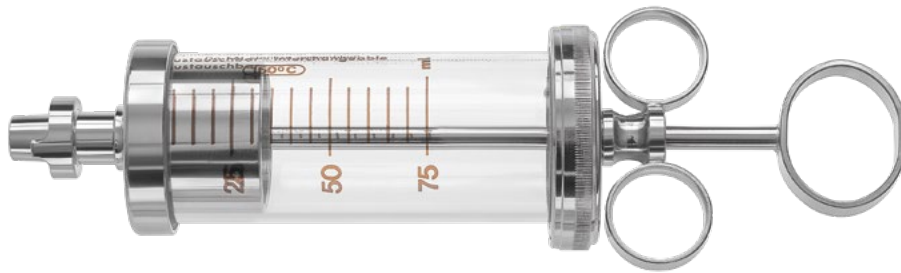

253-000-975 Bladder Syringe, 75cc
253-000-976 Spare glass cylinder, 75cc

253-000-900 Bladder Syringe, 100cc
253-000-901 Spare glass cylinder, 100cc

253-000-950★ Bladder Syringe, 150cc
253-000-951 Spare glass cylinder, 150cc

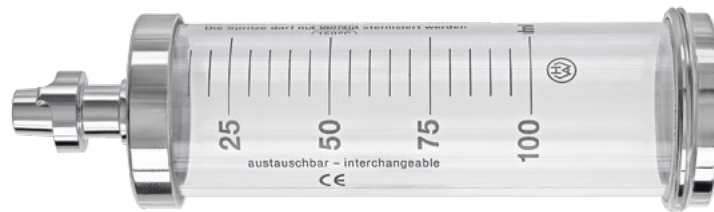

Spare glass cylinder

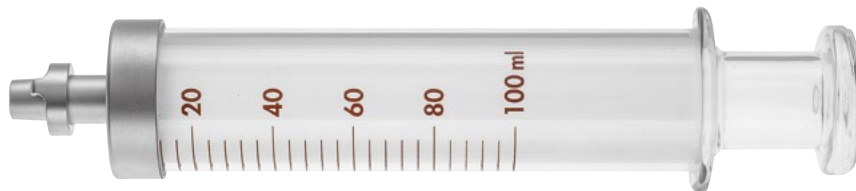

253-000-850 Toomey complete glass syringe, 50cc
253-000-800 Toomey complete glass syringe, 100cc

LIMITED
QUANTITY
AVAILABLE



253-000-810
Attachment for bladder catheters for use with Toomey syringes

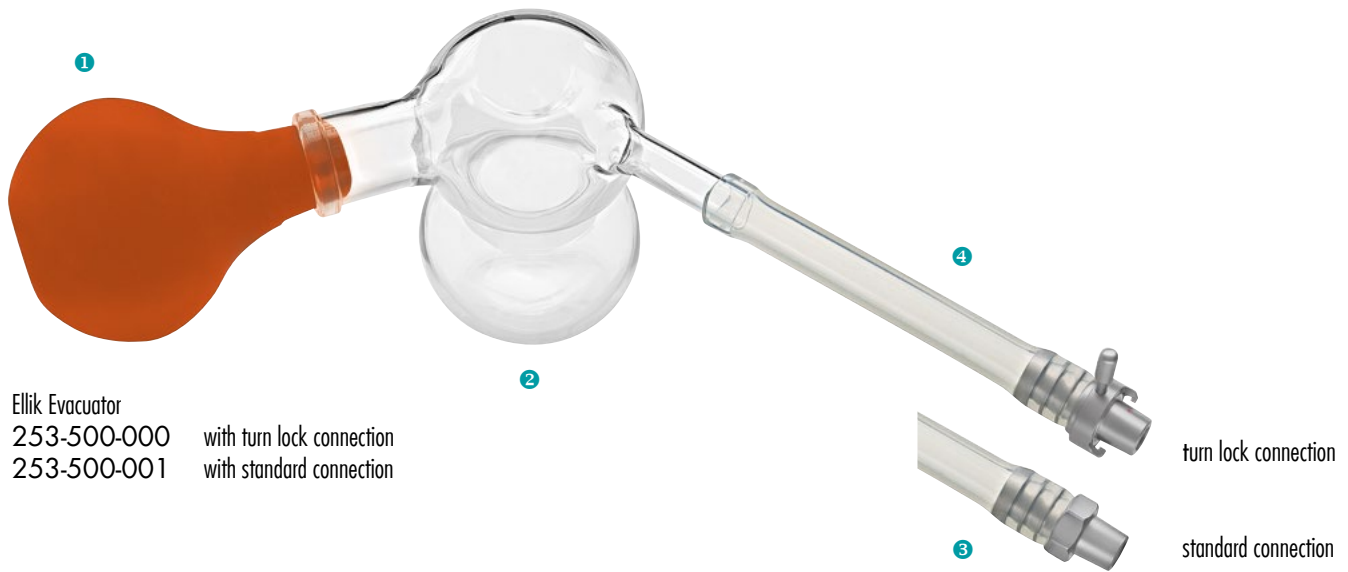

Elik Evacuator
 253-500-000 with turn lock connection
 253-500-001 with standard connection

- ① 253-500-003 Rubber ball
- ② 253-500-004 Glass body
- ③ 253-500-010 Standard connector with silicone tube
- ④ 253-500-020 Turn Lock connector with silicone tube



300-011-181★
 Luer-Lock tube connector 9mm



300-011-506★
 Luer-Lock tube connector 6mm



300-011-184★
 Luer-Lock Tuohy Borst Adapter



351-905-110
 Silicone Valve, reusable, for instruments up to Ø1.8mm (5.5Charr.) with LL-Connection, 10pcs. per package

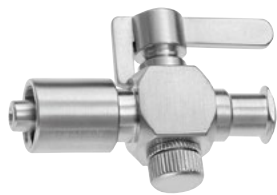

300-011-178
 Luer-Lock one-way stop-cock with spring screw cap

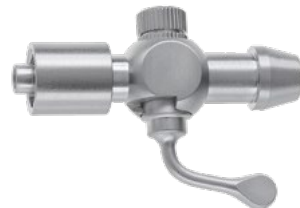

300-011-179★
 Luer-Lock tube connector with stopcock



300-011-515★
 Luer-Lock one-way stopcock



300-011-506
 Luer-Lock tube connector



300-400-900★
 Rubber Seals for Luer-Lock connectors



300-400-901★
 Rubber Seals for Luer-Lock connectors



301-701-100★
 Grey Rubber cap for use on all working channels



351-905-105
 Disposable Silicone Valve with Luer-Lock connection for use with 3 - 10 Charr. instruments sterile packed, package with 10 pieces



253-370-009 OTIS Bougie à Boule 9-12-15-18 Charr.
253-370-021 OTSI Bougie à Boule 21-24-27-30 Charr.



253-375-010 RZ Orifice Dilator 10-20 Charr.
253-375-015 RZ Orifice Dilator 15-30 Charr.

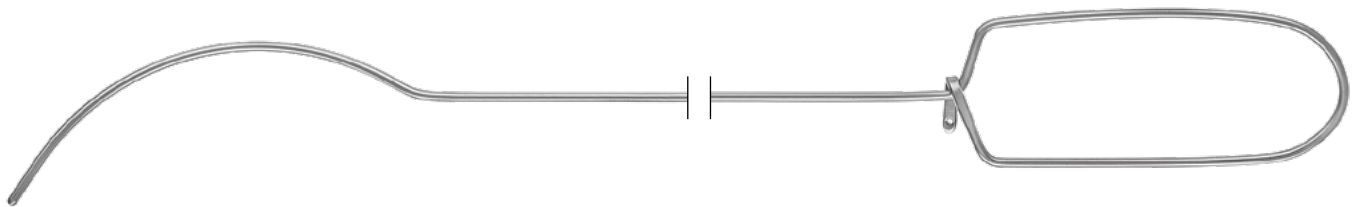

253-310-390★
Guyon Catheter Spanner & Introducer, curved, 390mm

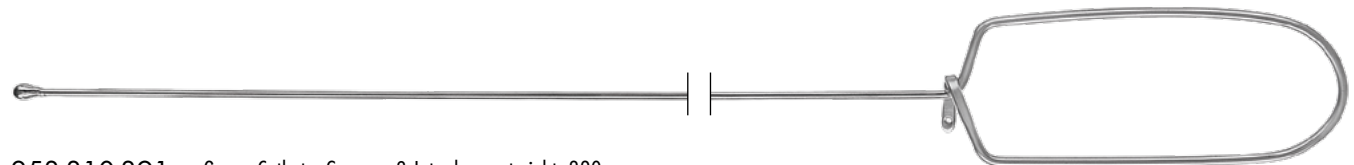

253-310-391 Guyon Catheter Spanner & Introducer, straight, 390mm
253-310-392 Guyon Catheter Spanner & Introducer, straight, 455mm
253-310-393 Guyon Catheter Spanner & Introducer, straight, 510mm

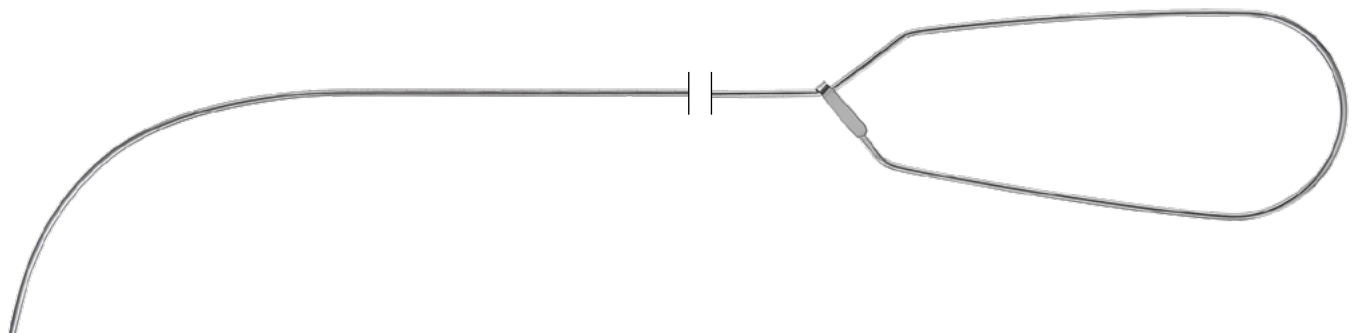

320-603-455
Foley Catheter Spanner & Introducer, curved, 455mm



Guyon Bougies, strong curved

| | | | | | |
|--------------|-----------|--------------|----------|--------------|----------|
| 253-340-335★ | 8 Charr. | 253-349-335★ | 22Charr. | 253-354-335★ | 28Charr. |
| 253-341-335 | 9 Charr. | 253-350-335★ | 24Charr. | 253-355-335★ | 30Charr. |
| 253-342-335★ | 10 Charr. | 253-351-335 | 25Charr. | 253-356-335 | 32Charr. |
| 253-343-335 | 11 Charr. | 253-352-335★ | 26Charr. | 253-357-335 | 34Charr. |
| 253-344-335★ | 12 Charr. | 253-353-335 | 27Charr. | | |
| 253-345-335★ | 14 Charr. | | | | |
| 253-346-335★ | 16 Charr. | | | | |
| 253-347-335★ | 18 Charr. | | | | |
| 253-348-335★ | 20 Charr. | | | | |



Van Buren Bougies, acutely curved

| | | | |
|--------------|-----------|--------------|-----------|
| 253-650-010★ | 10 Charr. | 253-650-024★ | 24 Charr. |
| 253-650-012★ | 12 Charr. | 253-650-026★ | 26 Charr. |
| 253-650-014★ | 14 Charr. | 253-650-028★ | 28 Charr. |
| 253-650-016★ | 16 Charr. | 253-650-030★ | 30 Charr. |
| 253-650-018★ | 18 Charr. | 253-650-032 | 32 Charr. |
| 253-650-020★ | 20 Charr. | 253-650-034 | 34 Charr. |
| 253-650-022★ | 22 Charr. | 253-650-036 | 36 Charr. |



Dittel Bougies, slightly curved

| | | | |
|--------------|-----------|--------------|-----------|
| 253-320-335★ | 8 Charr. | 253-329-335★ | 22 Charr. |
| 253-321-335 | 9 Charr. | 253-330-335★ | 24 Charr. |
| 253-322-335★ | 10 Charr. | 253-331-335 | 25 Charr. |
| 253-323-335 | 11 Charr. | 253-332-335★ | 26 Charr. |
| 253-324-335★ | 12 Charr. | 253-333-335 | 27 Charr. |
| 253-325-335★ | 14 Charr. | 253-334-335★ | 28 Charr. |
| 253-326-335★ | 16 Charr. | 253-335-335★ | 30 Charr. |
| 253-327-335★ | 18 Charr. | 253-336-335 | 32 Charr. |
| 253-328-335★ | 20 Charr. | 253-337-335 | 34 Charr. |



Dittel Bougies, straight

| | | | |
|-------------|-----------|-------------|-----------|
| 253-320-225 | 8 Charr. | 253-329-225 | 22 Charr. |
| 253-321-225 | 9 Charr. | 253-330-225 | 24 Charr. |
| 253-322-225 | 10 Charr. | 253-331-225 | 25 Charr. |
| 253-323-225 | 11 Charr. | 253-332-225 | 26 Charr. |
| 253-324-225 | 12 Charr. | 253-333-225 | 27 Charr. |
| 253-325-225 | 14 Charr. | 253-334-225 | 28 Charr. |
| 253-326-225 | 16 Charr. | 253-335-225 | 30 Charr. |
| 253-327-225 | 18 Charr. | 253-336-225 | 32 Charr. |
| 253-328-225 | 20 Charr. | 253-337-225 | 34 Charr. |



Ureteral Dilator, flexible, 500mm

| | | |
|--|-------------|-------------|
| | 253-920-090 | 9 Charr. |
| | 253-920-105 | 10.5 Charr. |
| | 253-920-120 | 12 Charr. |

| | | |
|--|-------------|-------------|
| | 253-920-135 | 13.5 Charr. |
| | 253-920-150 | 15 Charr. |



320-998-000
Stockmann Meatus Clamp, 8cm



320-999-000★
Strauss Penis Seizing Forceps, 13cm



Catheter for male

| | |
|-------------|-----------|
| 320-720-080 | 8 Charr. |
| 320-720-100 | 10 Charr. |
| 320-720-120 | 12 Charr. |
| 320-720-140 | 14 Charr. |
| 320-720-160 | 16 Charr. |
| 320-720-180 | 18 Charr. |
| 320-720-200 | 20 Charr. |
| 320-720-220 | 22 Charr. |
| 320-720-240 | 24 Charr. |



No sharp edges around fenestration



Catheter for female

| | |
|-------------|-----------|
| 320-721-080 | 8 Charr. |
| 320-721-100 | 10 Charr. |
| 320-721-120 | 12 Charr. |
| 320-721-140 | 14 Charr. |
| 320-721-160 | 16 Charr. |
| 320-721-180 | 18 Charr. |
| 320-721-200 | 20 Charr. |
| 320-721-220 | 22 Charr. |
| 320-721-240 | 24 Charr. |

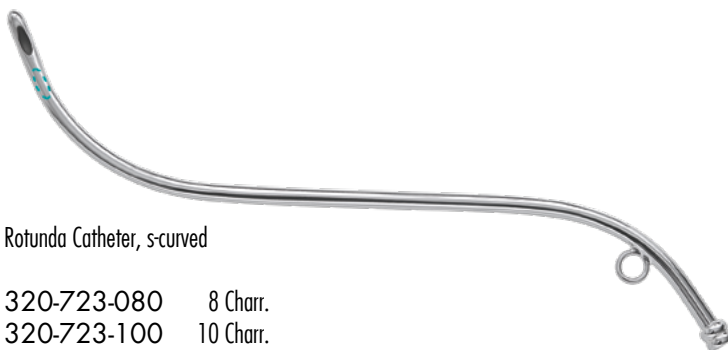

Rotunda Catheter, s-curved

| | |
|-------------|-----------|
| 320-723-080 | 8 Charr. |
| 320-723-100 | 10 Charr. |
| 320-723-120 | 12 Charr. |
| 320-723-140 | 14 Charr. |
| 320-723-160 | 16 Charr. |
| 320-723-180 | 18 Charr. |
| 320-723-200 | 20 Charr. |
| 320-723-220 | 22 Charr. |
| 320-723-240 | 24 Charr. |

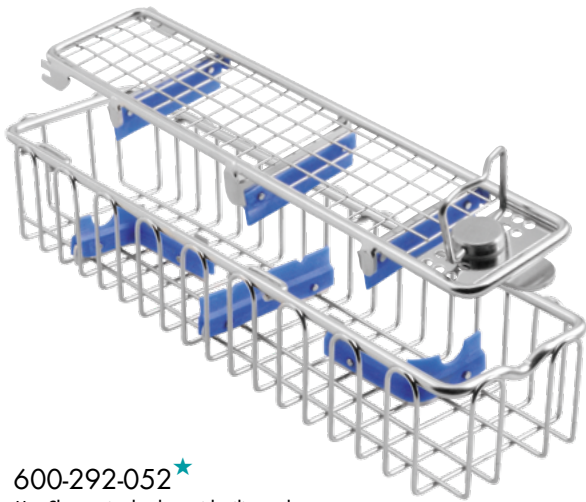

600-292-052★

MaxClean wire basket with silicone bars to hold 2 short endoscopes with maximum length of 190mm.
Dimensions: 290mm x 80mm x 52mm

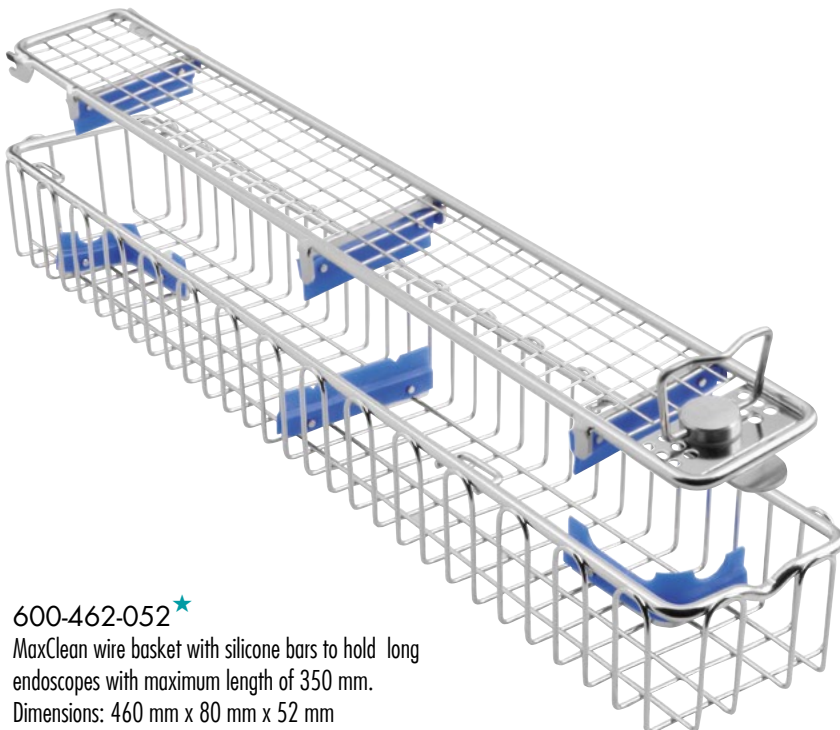

600-462-052★

MaxClean wire basket with silicone bars to hold long endoscopes with maximum length of 350 mm.
Dimensions: 460 mm x 80 mm x 52 mm

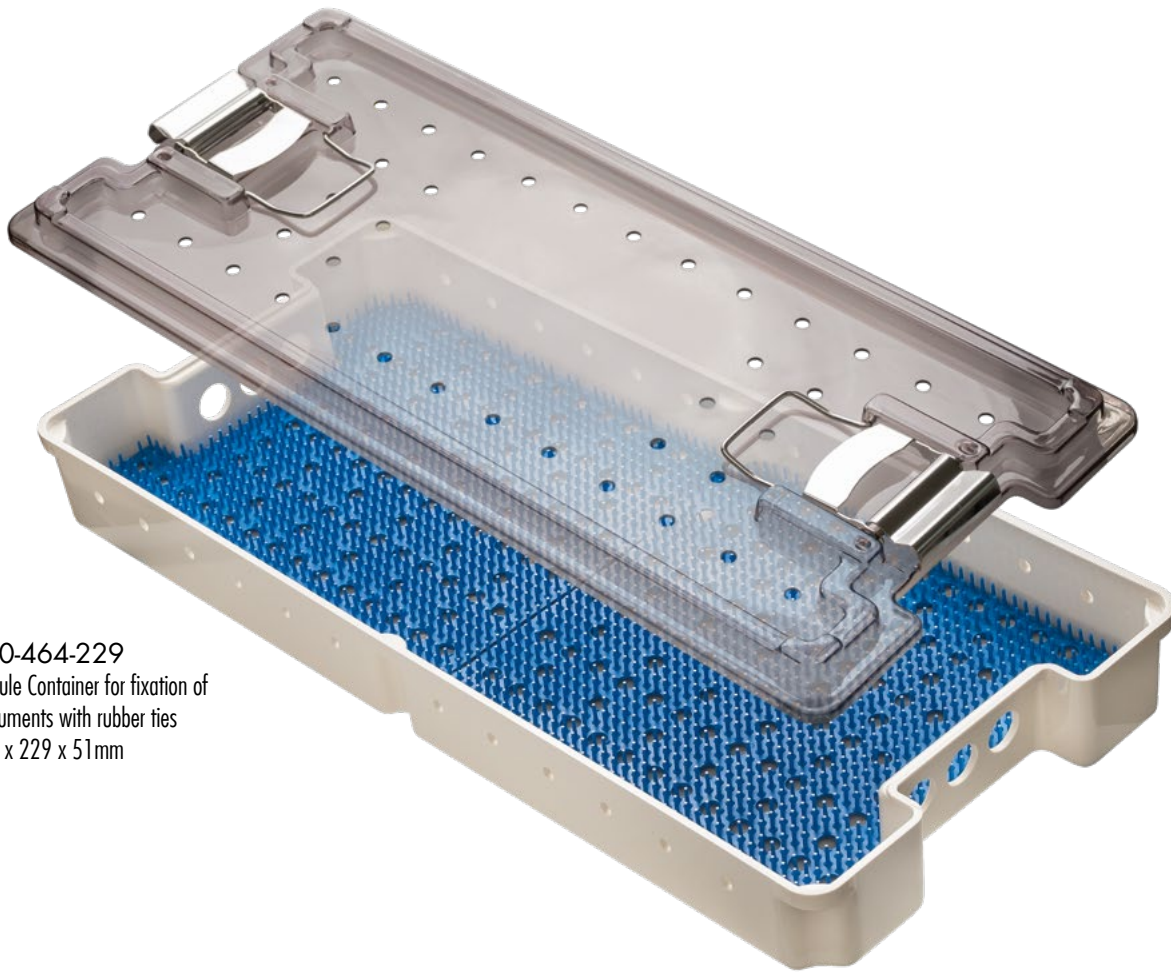

600-464-229
Module Container for fixation of
instruments with rubber ties
464 x 229 x 51mm

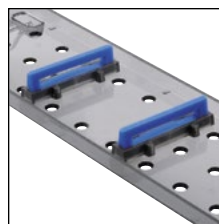
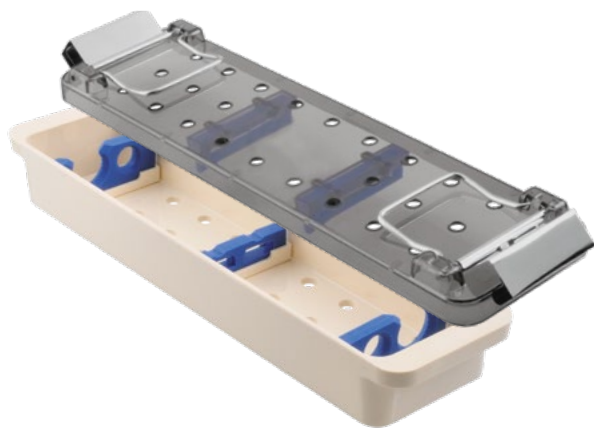

Safe and clean
with silicone bars on
base and lid

600-505-002 Safe+Clean double scope sterilization container to hold 2
short scopes with maximum length of 190 mm.
Dimensions: 271 mm x 70 mm x 35 mm

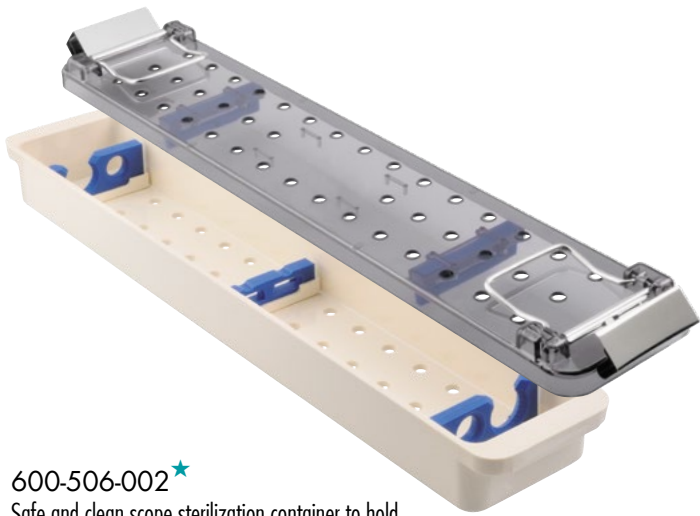

600-506-002★
 Safe and clean scope sterilization container to hold
 2 medium scopes with maximum length of 390 mm.
 Dimensions: 394 mm x 70 mm x 35 mm

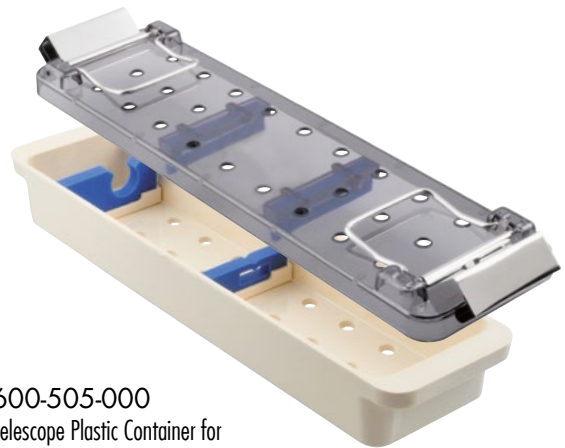

600-505-000
 Telescope Plastic Container for
 1 Telescope Ø 1-10mm max. length 270mm
 271 x 70 x 35mm

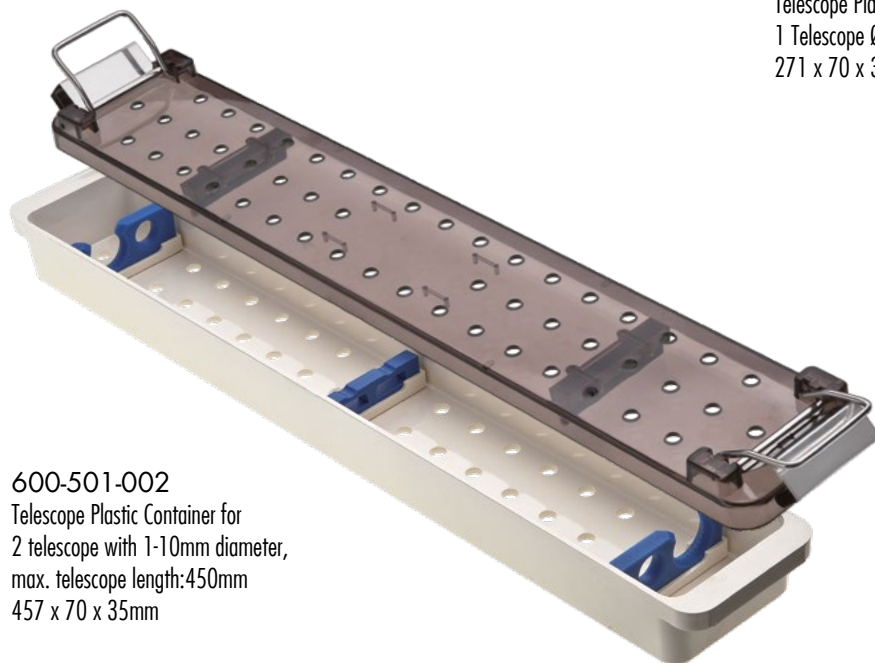

600-501-002
 Telescope Plastic Container for
 2 telescope with 1-10mm diameter,
 max. telescope length:450mm
 457 x 70 x 35mm

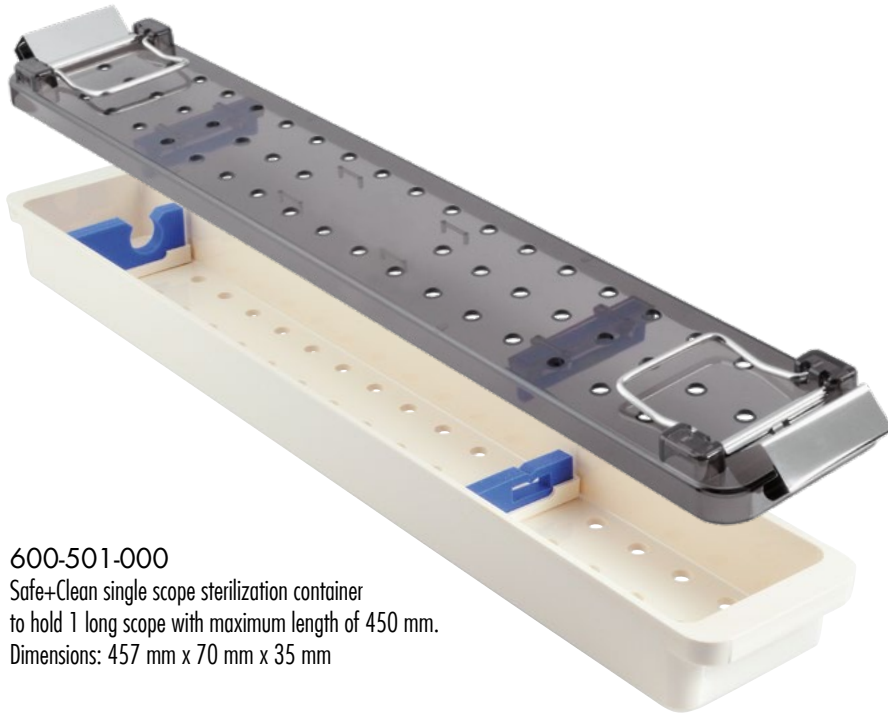

600-501-000
 Safe+Clean single scope sterilization container
 to hold 1 long scope with maximum length of 450 mm.
 Dimensions: 457 mm x 70 mm x 35 mm

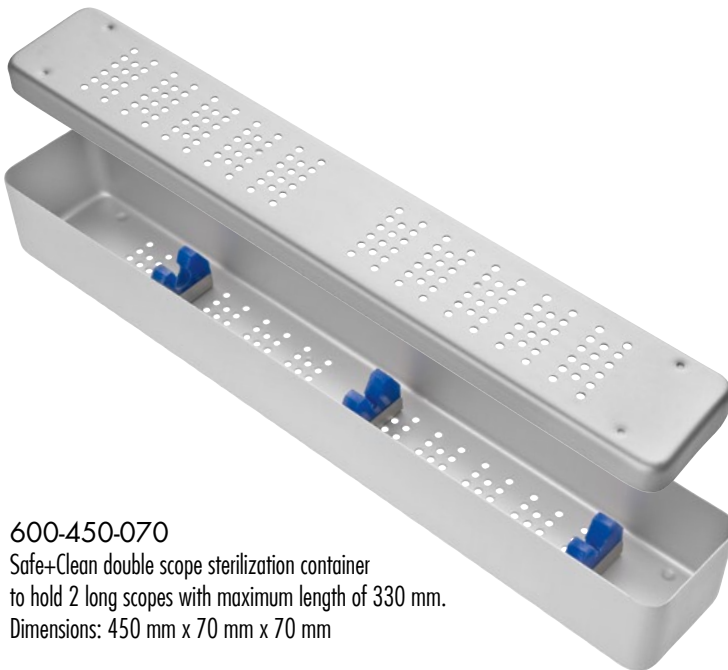

600-450-070
 Safe+Clean double scope sterilization container
 to hold 2 long scopes with maximum length of 330 mm.
 Dimensions: 450 mm x 70 mm x 70 mm

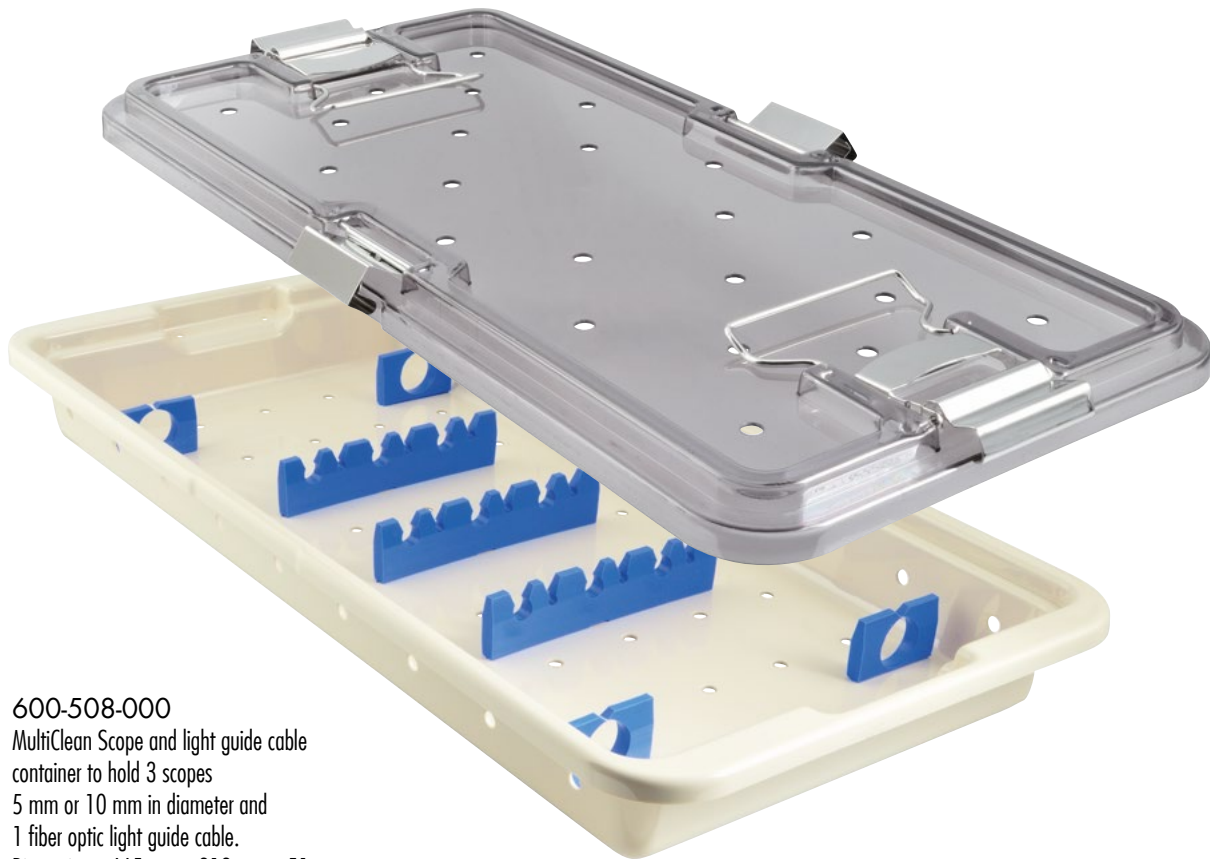

600-508-000
MultiClean Scope and light guide cable
container to hold 3 scopes
5 mm or 10 mm in diameter and
1 fiber optic light guide cable.
Dimensions: 465 mm x 212 mm x 51 mm



600-511-000
Universal Plastic Container, suitable for
sterilization of various instruments on 2 levels.
Dimensions: 502mm x 239mm x 102mm



600-140-003
Stainless Steel Box, non perforated
210x100x30mm



600-140-013
Stainless Steel Box, perforated
210x100x30mm



600-140-004
Stainless Steel Box, non perforated
210x100x50mm



600-140-014
Stainless Steel Box, perforated
210x100x50mm

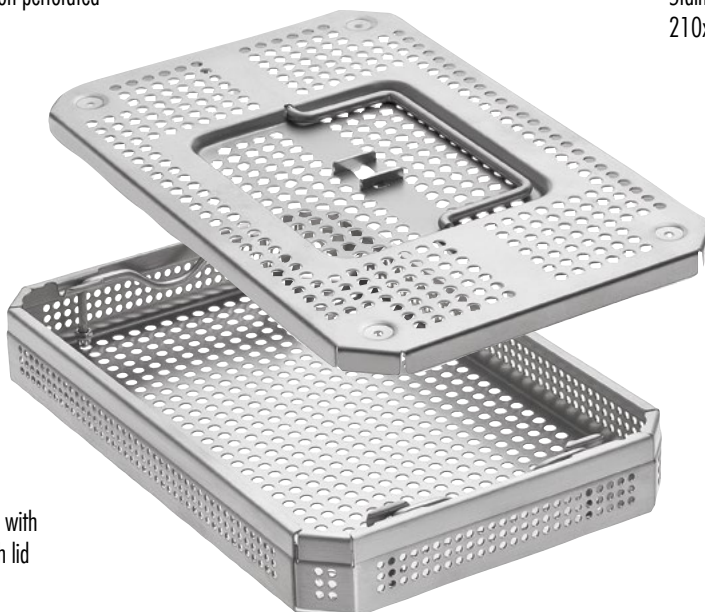

600-265-543
Stainless Steel Basket with
round perforation, with lid
265x175x43mm

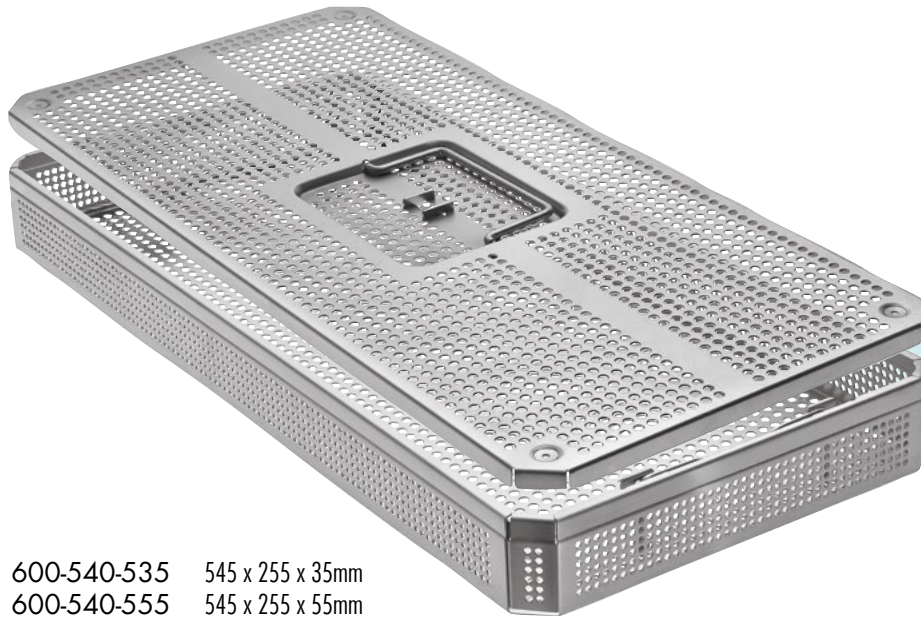

Stainless Steel Basket with
round perforation, with lid

545mm length

- 600-540-535 545 x 255 x 35mm
- 600-540-555 545 x 255 x 55mm
- 600-540-575 545 x 255 x 75mm
- 600-540-605 545 x 255 x 105mm



- Lid only
- 600-540-500 545 x 255 mm



- Bottom only
- 600-540-530 545 x 255 x 30mm
- 600-540-550 545 x 255 x 50mm
- 600-540-570 545 x 255 x 70mm
- 600-540-600 545 x 255 x 100mm

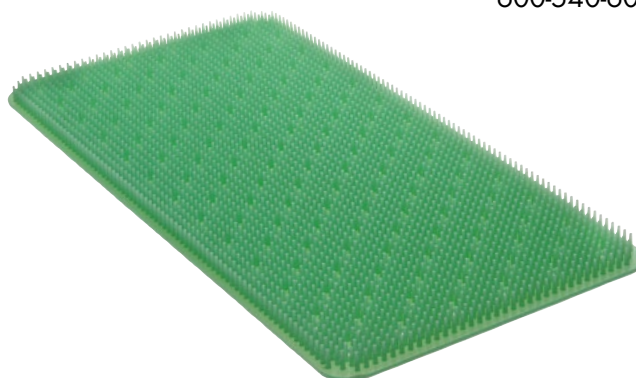

- 600-281-004 Silicone Mat green, 520x230mm

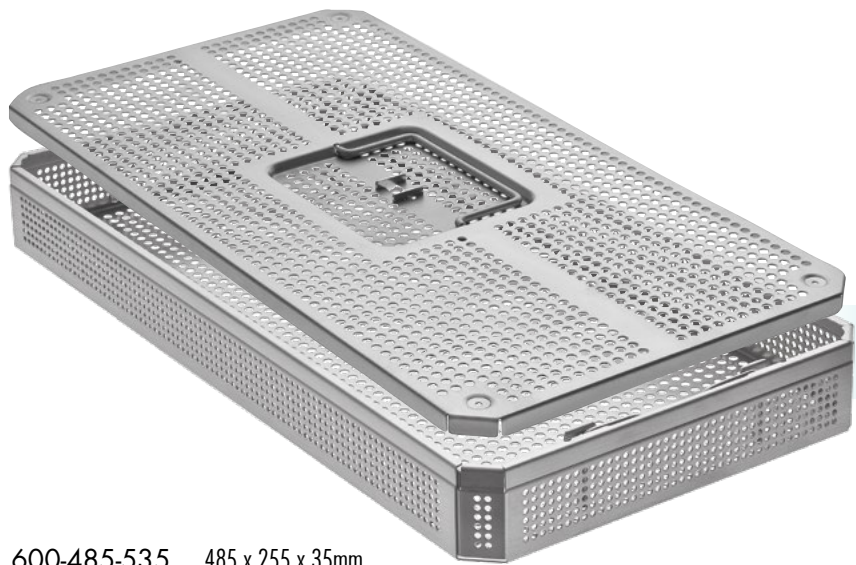

Stainless Steel Basket with round perforation, with lid

485mm length

- 600-485-535 485 x 255 x 35mm
- 600-485-555 485 x 255 x 55mm
- 600-485-575 485 x 255 x 75mm
- 600-485-605 485 x 255 x 105mm



- Lid only
- 600-485-500 485 x 255 mm

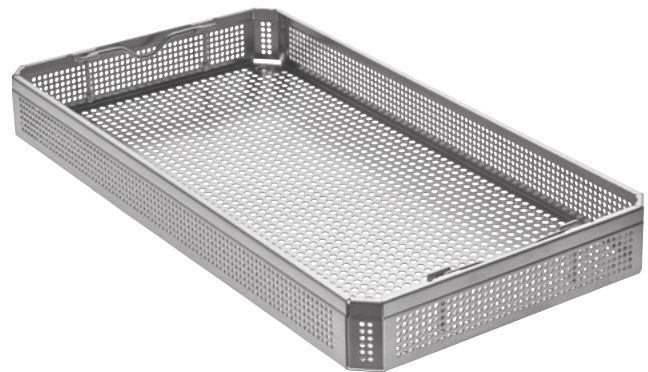

- Bottom only
- 600-485-530 485 x 255 x 30mm
 - 600-485-550 485 x 255 x 50mm
 - 600-485-570 485 x 255 x 70mm
 - 600-485-600 485 x 255 x 100mm

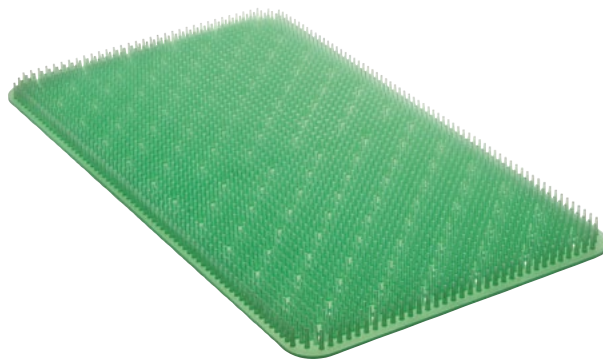

- 600-281-003 Silicone Mat green, 440x230mm

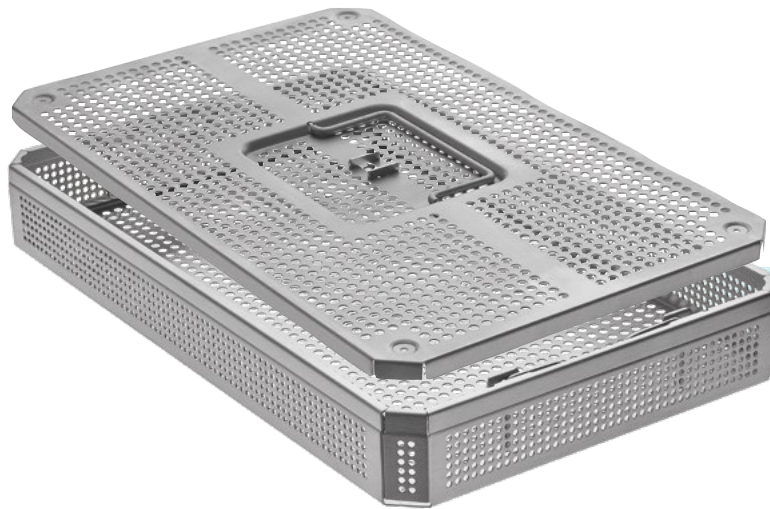

Stainless Steel Basket with round perforation, with lid

3/4
405mm length

- 600-405-535 405 x 255 x 35mm
- 600-405-555 405 x 255 x 55mm
- 600-405-575 405 x 255 x 75mm
- 600-405-605 405 x 255 x 105mm

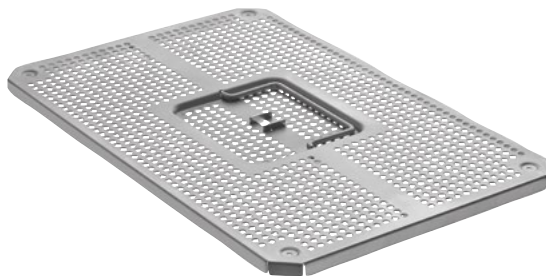

- Lid only
- 600-405-500 405 x 255 mm



- Bottom only
- 600-405-530 405 x 255 x 30mm
- 600-405-550 405 x 255 x 50mm
- 600-405-570 405 x 255 x 70mm
- 600-405-600 405 x 255 x 100mm

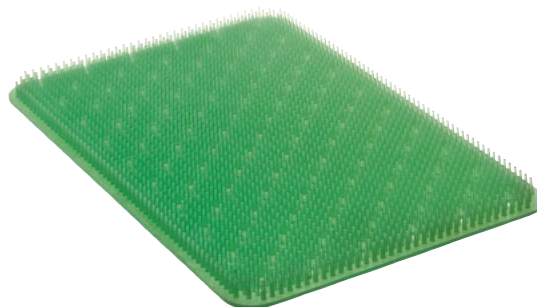

- 600-281-002 Silicone Mat green, 380x230mm



Stainless Steel Basket with
round perforation, with lid

1/2
255mm length

| | |
|-------------|-------------------|
| 600-255-535 | 255 x 245 x 35mm |
| 600-255-555 | 255 x 245 x 55mm |
| 600-255-575 | 255 x 245 x 75mm |
| 600-255-605 | 255 x 245 x 105mm |

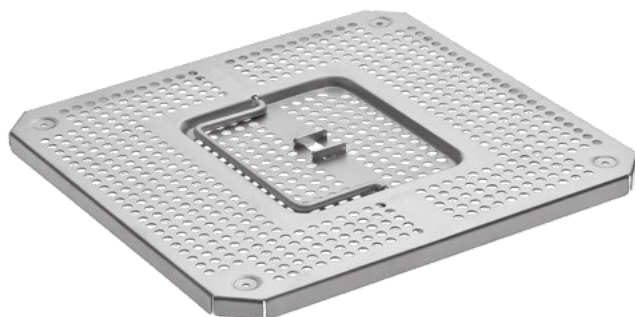

Lid only
600-255-500 255 x 245 mm



Bottom only
600-255-530 255 x 245 x 30mm
600-255-550 255 x 245 x 50mm
600-255-565 255 x 245 x 70mm
600-255-600 255 x 245 x 100mm



600-281-001 Silicone Mat green, 220x230mm



600-100-000
RZ-Aquajet
Water Jet Pistol complete
with 9 tips and 1m pressure
tubing, with strap and
suspension hook



700-900-160
Instrument Oil in 50ml bottle

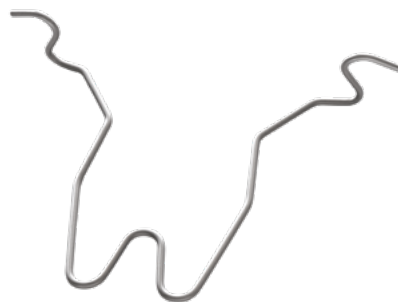

660-166-100
Holding Device for cleaning & sterilization

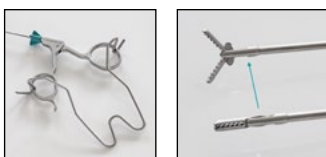

300-135-905
Cleaning brush for \varnothing 5mm, 500mm length (1 piece per box)



300-135-910
Cleaning brush for \varnothing 10mm, 500mm length (1 piece per box)



300-215-000
Cleaning brush, length 215mm, brush length 60mm, brush \varnothing 13mm



300-420-065
Cleaning brush, length 420mm, brush length 65mm, brush \varnothing 3mm



700-900-250
Oil Dispenser, 140mm



700-900-220
Special Cotton for polishing
metal sheaths and instruments

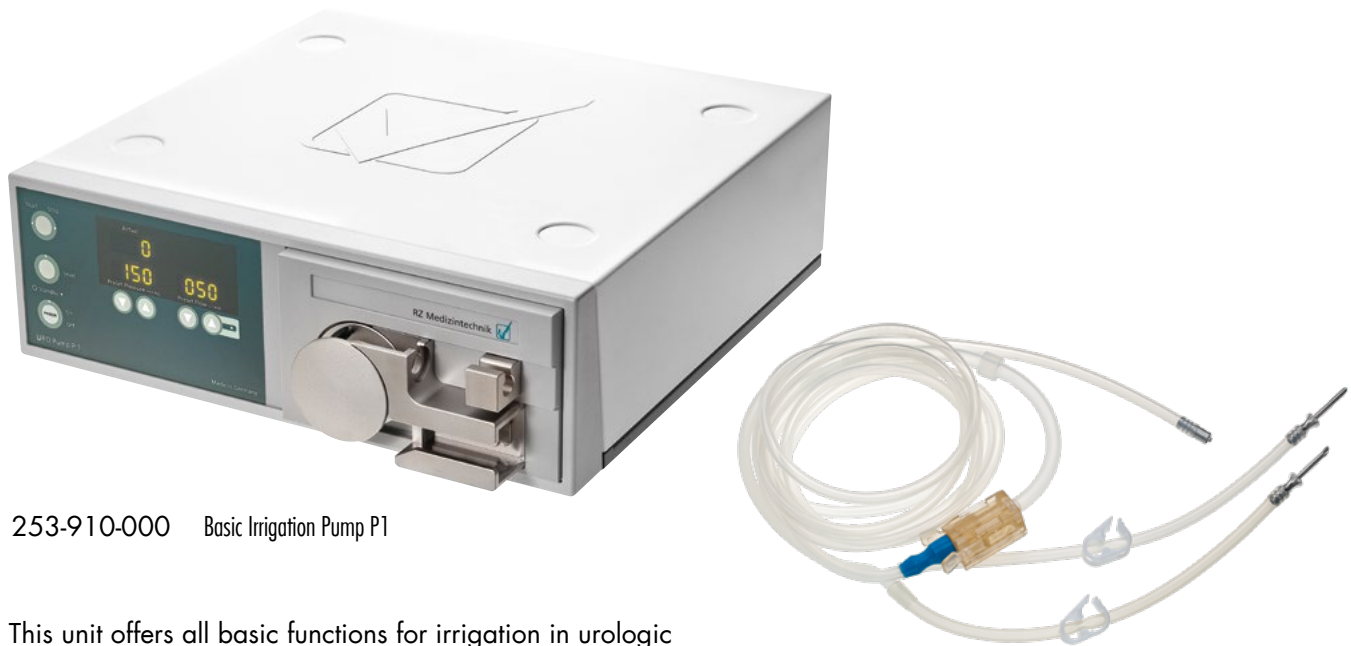

253-910-000 Basic Irrigation Pump P1

This unit offers all basic functions for irrigation in urologic surgery. Thanks to hydrostatic pressure regulation, the precise pressure in the treated body part is displayed. State-of-the-art and reliable technology features this versatile Pump.

Features:

- Hydrostatic pressure regulation
- Silicone tubing set included (225-910-001)
- Easy to operate, splash-proofed display
- Highly reliable tube guide and handling
- Skid-proof pedestals

Accessories (Urology)

| | | | |
|-------------|---|-------------|----------|
| 253-910-001 | Irrigation tubing set, silicone, autoclavable | non-sterile | included |
| 253-910-002 | Irrigation tubing set, PVC, 20 pieces, daily tube | sterile | optional |
| 253-910-003 | Patient tube, PVC, 2.5m, 40 pieces | sterile | optional |

Delivery contains:

- Pump device
- Tubing set
- Mains cable
- 2 Spare fuses

Technical data

| | |
|------------------|---------------------------|
| Line Voltage | 100-240 VAC |
| Power Input | 80VA |
| Irrigation Power | 0 - 1.0L/min |
| Pressure Range | 10 - 150mmHG |
| Measurements | 380 x 130 x 400mm (WxHxD) |
| Weight | approx. 11kg |



253-750-100
L 100 Lithotripter

- Energy transmission occur purely mechanically resulting an high efficient stone fragmentation
- The smallest probe diameter is only 0.6mm, which ensures a larger lumen for efficient irrigation. Auxiliary instruments can also be inserted
- The handling of the RZ URO LITH is very simple and all parts are easy to disassemble for cleaning purposes
- Our system is compatible to other RZ and other instruments for the therapy of ureteric, renal and bladder stones
- The hand piece as well as the intracorporale probe are non conductive elements which ensure the safety for patients as well as users against current conduct



253-750-010
Air compressor, 4 bar maximum



Litho Probe, 605mm working length

| | | | |
|-------------|-------|-------------|---------------------|
| 253-850-006 | 0.6mm | 253-850-016 | 1.6mm |
| 253-850-008 | 0.8mm | 253-850-020 | 2.0mm, 450mm length |
| 253-850-010 | 1.0mm | 253-850-025 | 2.5mm, 450mm length |
| 253-850-012 | 1.2mm | | |

253-750-011
PVC tube, 2.5m to connect lithotripter and air compressor (not illustrated)

253-750-201
Silicone tube to connect handpiece and lithotripter (not illustrated)



253-750-150
Footswitch



253-750-200
Hand piece, anodised

Technical data

| | |
|--------------------------|---|
| Line Voltage | 115-230 VAC |
| Pneumatic power source | 3.5 – 6.5 bar, compressed medical air |
| Pulse rate control (ppm) | 50 – 600 ppm 10 ppm increments between 50 - 100 ppm 50 ppm increments between 100 - 600 ppm |
| Dimensions | 254 x 113 x 305mm (WxHxD) |
| Weight | 6.5kg |

L100 Lithotripter Modular System Chart



Handpiece + RZ Probes

253-750-200

253-850-006/-008/-010
/012

URETEROSCOPY

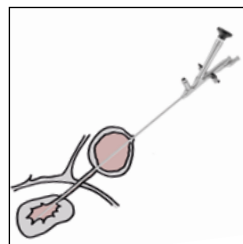

Telescope + Sheaths

253-905-540

Auxillary Instruments

253-954-005

253-750-200

253-850-020/-025

CYSTOSCOPY

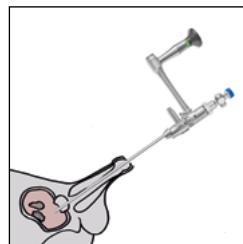

253-900-101

253-900-111
253-900-116

253-900-210

253-750-200

253-850-020/-025

PERCUTANEOUS NEPHROSCOPY

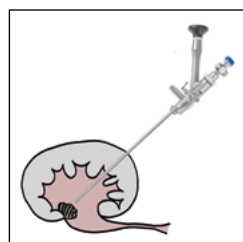

253-900-100

253-900-110
253-900-115

253-900-205



300-001-840 4K 3-Chip UHD-Camera K 4000

Features:

- 4K UHD resolution with 3-Chip technology
- Image algorithms enhancement of color and structure
- True natural colours for excellent live surgery imaging
- Recording function (video and picture)
- Camera head with 4 push buttons
- Boost function
- Zoom, freeze, fog reduction
- 10 USER modes configurations
- Multilingual menu
- SDI 4K Output

DELIVERY CONTAINS:

- Main Unit (300-001-840) • Camera head (300-001-842)
- HDMI cable • USB Pen Drive
- Mains cable • Operating manual

4K

**Ultra High Definition Quality
3840 x 2160 PIXELS**



Recording function on USB pen drive



Camera head with 4 raised push buttons



300-001-841
UHD 3-Chip Camera Head
(included in the set)



300-001-031
UHD 4K Monitor, 31", 4096 x 2160 pixels resolution



300-001-615
Title generator keyboard, waterproof IP68
US-Layout, cable 1.8m, color: grey,
305x140x15mm, 600gr.



300-001-610
Footswitch for HD Cameras
cable length: 2m

Technical data

| | |
|-------------------|-------------------------|
| Line Voltage | 100-240 VAC |
| Power consumption | 60VA |
| Image Sensor | 3 MOS |
| Resolution | 3840 x 2160 pixels (4K) |
| Index ratio | 16:9 |
| N/N ratio | 54db |

| | |
|---------------|---|
| Video outputs | 1x HDMI 4K 1x HDMI FullHD 1x SDI 4K 1x SDI FullHD |
| Dimensions | Control unit: 355 x 103 x 350mm (WxDxH) Weight control unit: 6.2kg Weight camera head: 145g |

FULL HD



300-001-804 3-Chip HD Camera F4

FEATURES:

- 3-Chip Full HD camera with latest MOS technology
- Pure Natural Colors technology
- Multitude of digital video outputs for best possible picture transmission to medical grade monitors
- 3 programmable remote control buttons
- User-friendly multilingual menu allows a large variety of setups to individual procedures and surgeons preferences
- Full HD 60fps video recording
- Full HD image saving
- USB pen drive included
- Boost function
- On-screen-menu
- 3 user settings storable
- 2.5x digital zoom
- Freeze function
- Text generator (optional with keyboard)

DELIVERY CONTAINS:

- Main Unit
- Camera head
- YPbPr/RGB cable
- 2x BNC cable
- HDMI - DVI cable
- HDMI cable
- S-Video cable
- Jack Cable
- USB Pen Drive
- Mains cable
- Operating manual

PURE NATURAL COLORS

Technical data

| | |
|------------------|-----------------------------|
| Line Voltage | 100-240 VAC |
| Power input | 20W |
| Image Sensor | 3 MOS |
| Resolution | 1920 x 1080 pixels (FullHD) |
| Image resolution | >1000 TV lines, horizontal |
| Index ratio | 16:9 |
| Min. sensitivity | < 3lx (1/1.4) |

Video outputs

Digital

2 x HD SDI
1 x HDMI / DVI 2x CVBS

Analog

1 x YpBPr / RGB
1 x Y/C (Pal/NTSC)
1 x CVBS (Pal/NTSC)

Shutter speed

1/50 (1/60) to 1/100.000sec

Dimensions

Control unit: 380 x 120 x 360mm (WxHxD)
Weight control unit: 11kg
Weight camera head: 145g

3-CHIP FULL HD IMAGING

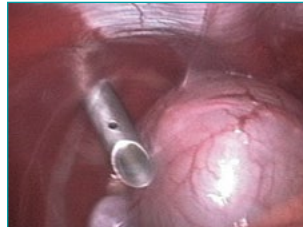

4:3 standard

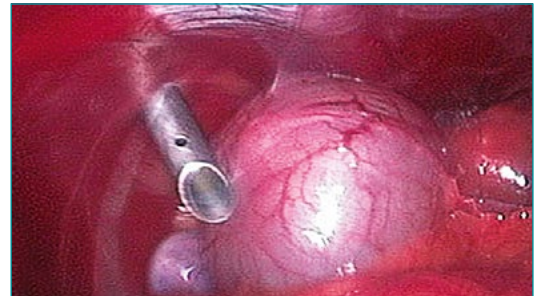

Latest 3-Chip MOS 16:9 technology

- 3-Chip Full HD camera with latest MOS technology for brilliant picture quality
- Pure Natural Colors technology
- Multitude of digital video outputs for best possible picture transmission to medical grade monitors



300-001-615
Title generator keyboard, waterproof IP68
US-Layout, PS/2 Connector, cable 1.8m
Color: grey, 305x140x15mm, 600gr.



300-001-610
Footswitch for HD Cameras,
cable length: 2m

ERGONOMIC CAMERA HEAD

(300-001-802)



- 3 programmable remote control buttons
- User-friendly multilingual menu allows a large variety of setups for individual procedures and surgeons preferences

FULL HD RECORDING

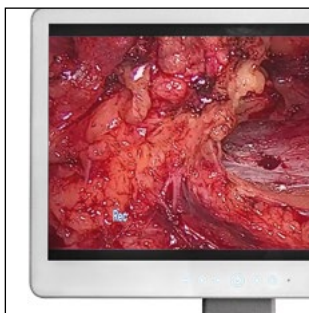

Full HD recording function



Recording and image controls

- Full HD 60fps video recording
- Full HD image saving
- USB pen drive included
- Boost function
- On-screen-menu
- 3 user settings storable
- 2.5x digital zoom
- Freeze function
- Text generator (optional with keyboard)

FULL HD



300-001-800 HD Camera F3 - High End

PURE NATURAL COLORS

Features:

- 3-Chip Full HD camera with latest MOS technology for brilliant picture quality
- User-friendly multilingual menu allows a large variety of setups for individual procedures and surgeons preferences
- Ergonomic camera head with 3 programmable remote control buttons by the user as required during surgery
- Multitude of digital video outputs for best possible picture transmission to the medical grade monitors
- Full HD
- HDMI output
- White balance, boost function
- On-screen-menu
- 3 user settings storable
- 2.5x digital zoom
- Freeze function
- Character generator

Delivery contains:

- Main Unit
- Camera head
- YPbPr/RGB cable
- BNC cable
- HDMI - DVI cable
- HDMI cable
- S-Video cable
- Jack Cable
- Mains cable
- User manual



FULL HD

300-001-802
High-End 3-Chip Camera Head
Full HD 1920 x 1080 pixels
(included)



300-001-615
Title generator keyboard, waterproof IP68
US-Layout, PS/2 Connector, cable 1.8m
Color: grey, 305x140x15mm, 600gr.



300-001-610
Footswitch for HD Cameras,
cable length: 2m

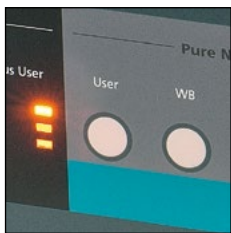

User-friendly, splash-
proofed display



Skid-proof pedestals

Technical data

| | |
|------------------|-----------------------------|
| Line Voltage | 100-240 VAC |
| Power input | 20W |
| Image Sensor | 3 - Chip |
| Resolution | 1920 x 1080 pixels (FullHD) |
| Image resolution | >1000 TV lines, horizontal |
| Index ratio | 16:9 |
| Min. sensitivity | < 3lx (1/1.4) |

| | |
|---------------|--|
| Video outputs | 1 x HDMI / DVI 1 x YPbPr (Component) 1 x Y/C (Pal/NTSC) 1x CVBS (Pal/NTSC) |
| Shutter speed | 1/50 (1/60) to 1/100.000sec |
| Dimensions | Control unit: 380 x 120 x 360mm (WxHxD) Weight control unit: 11kg Weight camera head: 145g |



300-001-601 HD Camera F2 PRO

Full HD

Features:

- 1-Chip Full HD camera of the latest generation, with superior image quality in high definition
- Natural color reproduction
- High-end image quality is provided by fully digital, high-speed image processing, separated for red, green and blue channels
- Significantly higher image quality and virtually all movements are eliminated
- Full HD 60fps video recording
- Full HD image storage
- USB pen drive included
- Full HD • HDMI out • White balance, boost function
- On-screen-menu • 3 user settings storable
- 2.5x digital zoom
- Freeze function
- Character generator

Delivery contains:

- Main Unit • Camera head
- USB pen drive • HDMI - DVI cable
- HDMI cable • S-Video cable
- RGB-Cable • BNC cable
- Mains cable • Operating manual

Optional available:

- 300-001-602 Camera Head
- 300-001-615 Title Generator Keyboard
- 300-001-610 Footswitch for HD Cameras

Technical data

| | |
|------------------|-----------------------------|
| Line Voltage | 100-240 VAC |
| Power input | 30W |
| Image Sensor | 1/3" MOS |
| Resolution | 1920 x 1080 pixels (FullHD) |
| Image resolution | >1000 TV lines, horizontal |
| Index ratio | 16:9 |
| Min. sensitivity | < 3lx (1/1.4) |

| | |
|---------------|---|
| Video outputs | 2 x HD SDI (optional) 1 x HDMI / DVI 1 x Y-Pb-Pr (Component) 1 x Video (PAL/NTSC) 1x S-Video (PAL/NTSC) |
| Dimensions | Control unit: 380 x 120 x 360mm (WxHxD) Weight control unit: 11kg Weight camera head: 105g |



300-001-600 HD Camera F1

FULL HD

Features:

- 1-Chip Full HD camera of the latest generation, with superior image quality in high definition
- Natural color reproduction
- High-end image quality is provided by fully digital, high-speed image processing, separated for red, green and blue channels
- Significantly higher image quality and virtually all movements are eliminated
- Full HD
- HDMI out
- White balance, boost function
- On-screen-menu
- 3 user settings storable
- 2.5x digital zoom
- Freeze function
- Character generator

Delivery contains:

- CCU
- Camera head with 3m cable
- Mains cable
- YPbPr/RGB cable
- BNC cable
- HDMI - DVI cable
- HDMI cable
- RGB cable
- User manual

Optional available:

- 300-001-602 Camera Head
- 300-001-615 Title Generator Keyboard
- 300-001-610 Footswitch for HD Cameras

Technical data

| | |
|------------------|-----------------------------|
| Line Voltage | 100-240 VAC |
| Power input | 20W |
| Image Sensor | 1/3" MOS |
| Resolution | 1920 x 1080 pixels (FullHD) |
| Image resolution | >1000 TV lines, horizontal |
| Index ratio | 16:9 |
| Min. sensitivity | < 3lx (1/1.4) |

| | |
|----------------------|---|
| Video outputs | 1 x HDMI |
| | 1 x YPbPr / RGB |
| | 1 x S-Video (Y/C; Pal / NTSC) |
| | 1 x Video (CVBS; Pal / NTSC) |
| Dimensions | Control unit: 380 x 120 x 360mm (WxHxD) |
| | Weight control unit: 11kg |
| | Weight camera head: 105g |



300-001-410 Camera Z2

Features:

- 1-Chip MOS FullHD Camera
- All features of the camera can be directly controlled and set up on a menu
- Digital Anti Moiré filter automatically eliminates disturbing distortions when using flexible endoscopes
- To be prepared to work under extreme illumination conditions, the control unit offers further features to improve the image quality (WINDOW- and PEAK-function)
- Lightweight camera head
- 3 programmable remote control buttons on the camera head
- Additional USB port for flash drives allows external storage of recorded data.

Delivery contains:

- Main Unit (300-001-410)
- Camera head (300-001-410.1)
- HDMI/DVI Cable
- HDMI cable
- 4GB USB Pen Drive
- Mains cable
- Operating manual

Technical data

| | |
|--------------|---|
| Line Voltage | 100-240 VAC |
| Image Sensor | 1/3" MOS |
| Resolution | 1920 x 1080 pixels (FullHD) |
| Index ratio | 16:9 |
| Outputs | 1x HDMI |
| Connections | 1x USB, 1x Remote IN 2 x Remote OUT, 2x RJ45 |

| | |
|------------------------------|---|
| Safety Class (EN 60601-1) | I |
| Classification (EU 2017/745) | I |
| Application part | BF |
| Dimensions | Control Unit: 380 x 132 x 378 mm Camera Head: Ø38 x 79mm |
| Weight | Control Unit: approx. 9kg Camera Head: 180g |



300-001-400 Camera Z1

Features:

- 1-Chip MOS FullHD Camera
- All features of the camera can be directly controlled and set up on a menu
- Digital Anti Moiré filter automatically eliminates disturbing distortions when using flexible endoscopes
- To be prepared to work under extreme illumination conditions, the control unit offers further features to improve the image quality (WINDOW- and PEAK-function)
- Lightweight camera head
- 3 programmable remote control buttons on the camera head

Delivery contains:

- Main Unit (300-001-410)
- Camera head (300-001-410.1)
- HDMI/DVI Cable
- HDMI cable
- Mains cable
- Operating manual

Technical data

| | |
|--------------|---|
| Line Voltage | 100-240 VAC |
| Image Sensor | 1/3" MOS |
| Resolution | 1920 x 1080 pixels (FullHD) |
| Index ratio | 16:9 |
| Outputs | 1x HDMI |
| Connections | 1x USB, 1x Remote IN 2 x Remote OUT, 2x RJ45 |

| | |
|------------------------------|---|
| Safety Class (EN 60601-1) | I |
| Classification (EU 2017/745) | I |
| Application part | BF |
| Dimensions | Control Unit: 380 x 132 x 378 mm Camera Head: Ø38 x 79mm |
| Weight | Control Unit: approx. 9kg Camera Head: 180g |

TV COUPLER



300-001-823 f=14mm
 300-001-824 f=25mm
 300-001-825 f=28mm
 c-mount, soakable,
 4K and FullHD compatible



250-015-030
 Zoom-TV-Adapter
 f=15 - 30mm
 c-mount, soakable,
 4K and FullHD compatible



250-020-025 F=25mm (splitting 90/10)
 250-020-030 F=30mm (splitting 90/10)
 Beamsplitter, allows simultaneous video and
 direct views, c-mount, soakable, Full HD

RZ MEDIA WORKSTATION Innovative Documentation System – the stand alone “all in one” solution

Sophisticated users get a comprehensive tool for creating, documenting and archiving of videos, pictures and findings.

An extensive set of tools gives the ability for easy creation of individual and complex findings reports. Easy integration into IT-environment ensures an optimal workflow. The database provides long-term availability of picture findings with almost no capacity limitation.

Diagnostics & Results

- Recording of videos and pictures
- PACS support DICOM worklist/store
- Playing videos with abstraction of individual images
- Manual input of comments and markers for sessions and recordings
- Graphical markers with individual comments
- Creation of reports incl. patient information, pictures, videos and comments
- Full-text search in data base
- User management including import, adaption and export of patients
- LIVE OR communication via e.g. Zoom, Skype or Teams
- Hospital Safety guidelines (Windows based network and firewall)



Documentation System 21" touch

300-001-199 OR version with DICOM worklist
300-001-198 without DICOM worklist





| Order number | Description |
|--------------|--|
| 300-900-300 | LUMEN LED 3 PRO Light Source, 110 - 230V |

The new RZ LUMEN LED 3 PRO Light Source provides latest LED technology. Extensive light output with pure daylight quality (approx. 6500 Kelvin) gives you the exclusive vision on all anatomical structures. An easy-to-use turret connector helps to connect the most common cables.



- A OLYMPUS
- B WOLF
- C GYRUS/ACMI
- D STORZ

Turret, multi connector

- Daylight quality
- Strong light output
375W equivalent
- Compatible to
different light cables

Delivery contains:

- Main unit
- BNC cable
- Mains cable
- User manual

Technical data

| | |
|------------------|--|
| Line Voltage | 100-240 VAC |
| Video input | 1x Video, BNC |
| Protection class | 1 (acc. IEC 60601-1) 1 (acc. MDD 93/42/EEC) |
| Safety class | BF |
| Standard | IEC 60601-1-2 |
| Dimensions | 380 x 120 x 360mm (WxHxD) |
| Weight | approx. 11kg |

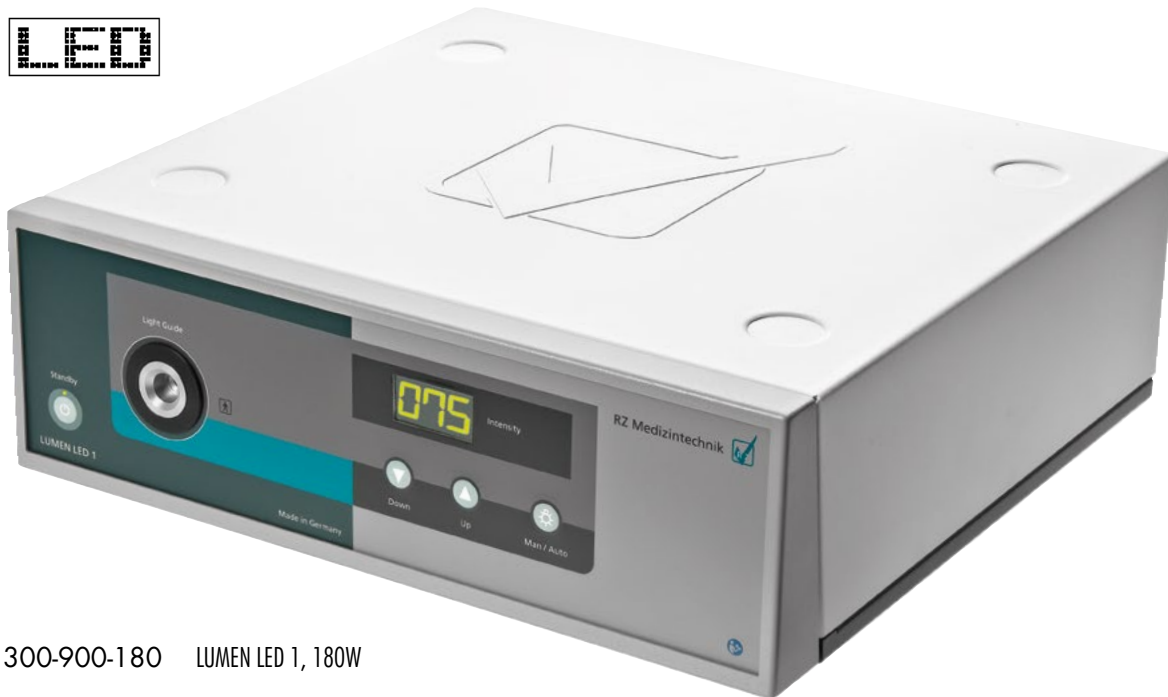

300-900-180 LUMEN LED 1, 180W

Benefit of the newest LED technology - this Light Source offers increased luminous efficiency by lowest heat conduction and operating costs. The daylight quality LED Lamp lifetime is more than 20.000 hours to provide enhanced working.

Delivery contains:

- Light source
- Mains cable
- BNC cable
- User manual

Features:

- More than 20.000h lamp lifetime
- Manual or automatic light control
- Waterproof touch control panel
- Low heat conduction by improved LED technology
- Daylight color temperature 6000 – 6500° K for accurate color representation
- Boost function: temporarily increase of light power of 20% additionally to the 100% light output



Automatic or manual light intensity control



Digital light intensity display

Technical data

| | |
|-------------------|--|
| Line Voltage | 100-240 VAC |
| Power consumption | 130VA |
| Video input | 1x Video, 1x S-Video (Y/C) (automatic version only) |
| Protection class | 1 (acc. IEC 60601-1) 1 (acc. MDD 93/42/EEC) |
| Safety class | BF |
| Dimensions | 380 x 120 x 360mm (WxHxD) |
| Weight | approx. 11kg |

High Temperature LED/Xenon Light Cables

The advanced High Temperature Xenon Light cables feature a built-in glass rod on the light source side to protect the fibers from melting when the cables are used with high-power Xenon light sources.

All 3.5mm and 4.8mm light cables feature a robust silicone hose to protect the light cables against damages like cuts or crushes.

A bending protection on the connectors is a basic feature of every RZ High Temperature Xenon Light cable.





Adapter pieces for fibre light guide to use with **light source**

XENON light guide, without adapter pieces

- 250-025-230 \varnothing 2.5 mm, 2300 mm
- 250-025-300 \varnothing 2.5 mm, 3000 mm
- 250-035-180 \varnothing 3.5 mm, 1800 mm
- 250-035-230 \varnothing 3.5 mm, 2300 mm
- 250-035-300 \varnothing 3.5 mm, 3000 mm
- 250-048-180 \varnothing 4.8 mm, 1800 mm
- 250-048-230 \varnothing 4.8 mm, 2300 mm
- 250-048-300 \varnothing 4.8 mm, 3000 mm



250-039-000 RZ/Storz



250-037-000 Wolf



250-038-000 ACMI/British Standard
CUDA



250-044-000 Olympus



250-048-000 Luxtec



250-045-000 Olympus - Standard



250-051-000 Stryker



250-052-000 Heine



250-042-000 RZ/Storz/Olympus



250-040-000 Wolf



250-041-000 ACMI/British Standard



250-059-000 Pentax

Adapter pieces for fibre light guide to use with **endoscope**



COMPATIBILITY NOTE:

A fiber optic cable with a bigger diameter should not be connected to a smaller diameter scope.
For example: a \varnothing 4.8mm fiber optic cable adapted to a \varnothing 2.9mm or \varnothing 4mm endoscope may lead to burning at the light entry of the endoscope and even endanger the patient.

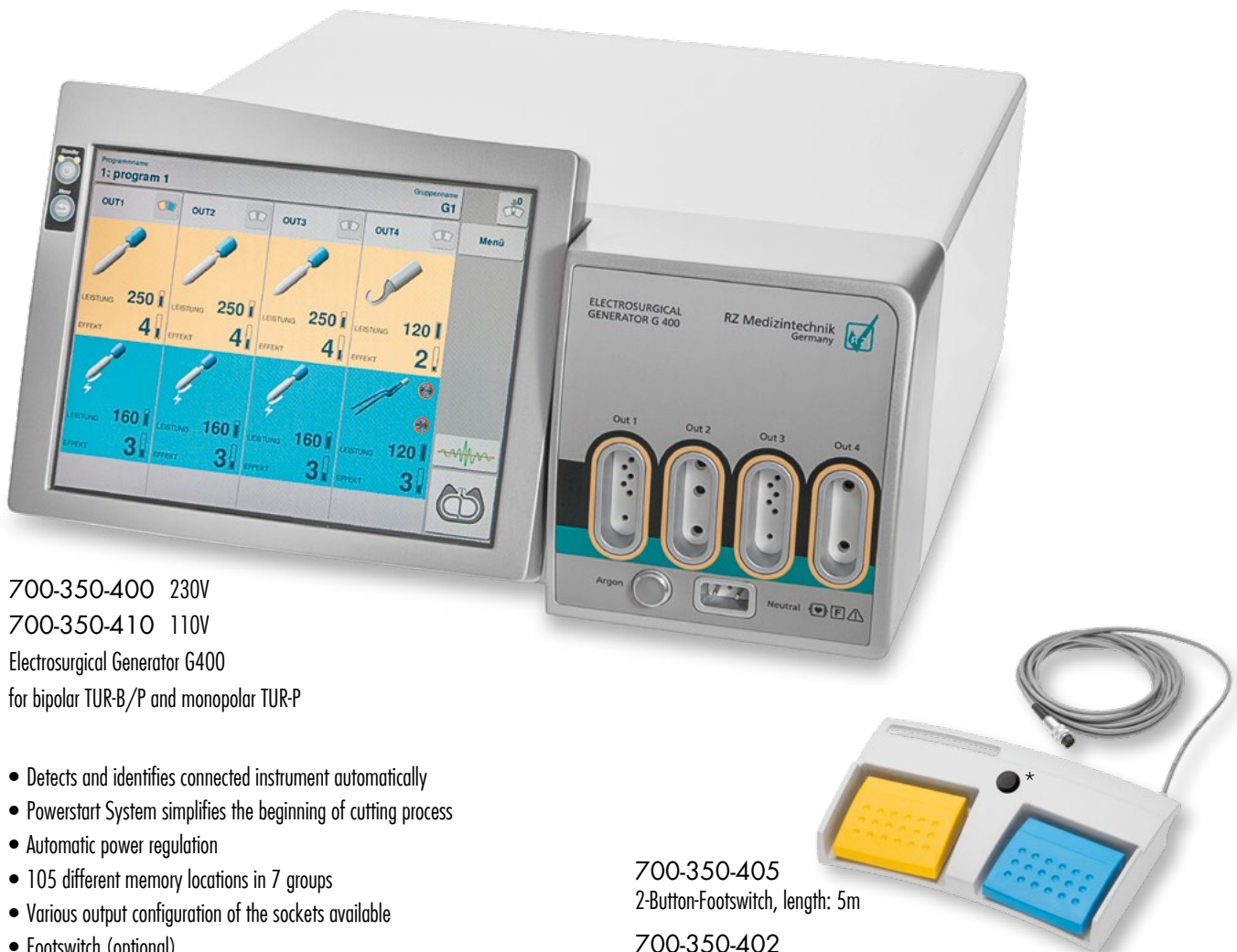

700-350-400 230V
700-350-410 110V
Electrosurgical Generator G400
for bipolar TUR-B/P and monopolar TUR-P

- Detects and identifies connected instrument automatically
- Powerstart System simplifies the beginning of cutting process
- Automatic power regulation
- 105 different memory locations in 7 groups
- Various output configuration of the sockets available
- Footswitch (optional)
- Available with Argon and / or the RZeal

700-350-405
2-Button-Footswitch, length: 5m

700-350-402
*2-Button-Footswitch and 1 Vario-Switch-Button, length: 5m

Technical data

| | |
|-----------------------------------|---|
| Line Voltage | 110-230 VAC |
| Power consumption | 500W |
| Generator operation frequency | 333kHz |
| Defibrillation impulse resistance | acc. to to EN 60601-1 |
| NEM system | neutral electrode control optical indication 7 levels required resistance < 240 Ω |
| Gas type | pure argon 4.8 (99,998%) or higher |
| Inlet gas pressure | 0.25-0.4 [MPa] |

| | |
|-----------------------|---|
| Gas outflow | 0.1-10 l/min, regulated 0.1 l/min in whole range |
| Pressure range | reducer (0.4 MPa) on argon cylinder |
| Vessel sealing system | 9 effects/300W |
| AutoStop | automatic stop of sealing process after achieving the optimal effect |
| Dimensions | 495 x 415 x 225mm (LxWxH) |
| Weight | 12.2kg |

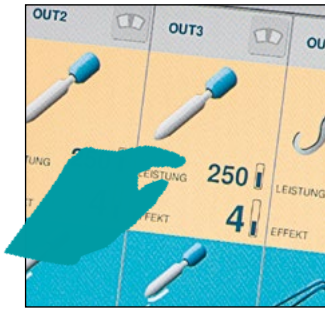

10" Touchscreen



Easy readable interface design

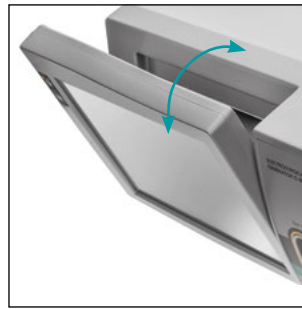

Tiltable display



Instrument detecting sockets

Cutting and Coagulation features

MONOPOLAR CUTTING

| | |
|---------------|----------------|
| Mono Cut | 9 effects/350W |
| Precise Cut | 9 effects/50W |
| Mixed Cut | 9 effects/150W |
| Polipo Cut** | 9 levels |
| Papillo Cut** | 9 levels |
| Arthro Cut** | 9 levels |
| Uro Cut** | 9 levels |
| Hystero Cut** | 9 levels |
| Argon Cut** | 9 effects/350W |

BIPOLAR CUTTING

| | |
|-----------------|----------------|
| Bi-Cut** | 9 effects/120W |
| Uro Bi-Cut** | 9 levels |
| Arthro Bi-Cut** | 9 levels |

MONOPOLAR COAGULATION

| | |
|-----------------|----------------|
| Soft Coag | 9 effects/200W |
| Forced Coag | 9 effects/200W |
| Spray Coag | 80W |
| Hybrid Coag | 9 effects/200W |
| Standard Argon* | 80W |
| Endo Argon* | 40W |
| Pulse Argon* | 40W |
| Uro Coag** | 9 levels |
| Arthro Coag** | 9 levels |
| Hystero Coag** | 9 levels |

BIPOLAR COAGULATION

| | |
|------------------|--------------------------------------|
| Soft Bi-Coag | 9 effects/120W AutoStart/AutoStop |
| Forced Bi-Coag | 9 effects/120W AutoStop |
| Uro Bi-Coag** | 9 levels |
| Arthro Bi-Coag** | 9 levels |
| Sciss Bi-Coag** | 9 levels |



700-503-003
Cable for Disposable Neutral Electrode
5m, only RZ compatible



700-503-000 Adults
700-503-001 Children
Disposable Neutral Electrode
hydrogel, split, for adults or children
10x5 pcs. per package

Modifications of technical specification or design are subject to change without prior notice.

* available only for Argon version

** special mode available only for dedicated SDS cable/instrument connected



700-340-400 230V
 700-340-410 110V
 Electrosurgical Generator G44

- Intelligent Instrument detection system
- Intuitive Touchscreen
- Automatic power regulation
- Configurable working modes
- Real-time parameter control
- Special endoscopic modes
- Bipolar resection
- Easy software update



700-503-003
 Cable for Disposable Neutral Electrode
 5m, only RZ compatible



700-350-405
 2-Button-Footswitch, length: 5m

700-350-402
 *2-Button-Footswitch and 1 Vario-Switch-Button, length: 5m



700-503-000 Adults
 700-503-001 Children
 Disposable Neutral Electrode
 hydrogel, split, for adults or children
 10x5 pcs. per package

| | |
|-------------------------|--|
| Display | TFT 7" WVGA |
| SpectrumResult system | automatic power regulation |
| Length / Width / Height | 385mm / 305mm / 141mm |
| Weight | 7kg |
| Power Supply Voltage | 220-240 V ± 10% 50/60 Hz or 110-120 V ± 10% 50/60 Hz |
| Rated power input | 1100 VA |

Safety features

| | |
|-----------------------------------|--|
| Protection against electric shock | I / CF |
| Low-frequency leakage currents | according to IEC 60601-1 |
| High-frequency leakage currents | according to IEC 60601-2-2 |
| Generator operation frequency | 333 kHz |
| Defibrillation impulse resistance | according to IEC 60601-1 |
| NEM System | neutral electrode control, optical indication, required resistance < 240 Ω |

Monopolar Coagulation max. 200W (200 Ω)

| | |
|--------------|------------------|
| Soft Coag | 9 effects |
| Forced Coag | 9 effects |
| Spray Coag | 80 effects / 80W |
| Hybrid Coag | 9 effects |
| Uro Coag | 9 effects |
| Hystero Coag | 9 effects |

Monopolar Cutting max. 400W (100 Ω)

| | |
|-------------|-----------|
| Mono-Cut | |
| Precise Cut | |
| Mixed Cut | 9 effects |
| Uro Cut | |
| Hystero Cut | |

Bipolar Coagulation max. 400W (25 Ω)

| | |
|----------------|--------------------------------|
| Soft Bi-Coag | 9 effects AutoStart / AutoStop |
| Forced Bi-Coag | 9 effects AutoStop |
| Uro Bi-Coag | 9 effects |
| Sciss Bi-Coag | 9 effects |

Bipolar Cutting max. 330W (150 Ω)

| | |
|------------|-----------|
| Bi-Cut | 9 effects |
| Uro Bi-Cut | 9 effects |



300-001-168
Endovue 32" HD Monitor

300-001-158
Endovue 24" HD Monitor

Technical data

| | |
|-------------------|--|
| Screen size | 31.5" / 24" diagonal |
| Resolution | 1920 x 1080 |
| Aspect ratio | 16:9 |
| Viewing angle | 178° |
| Numbers of colors | 16.7 Million (8-bit) |
| Video Inputs | DVI-D, RGBS/VGA/YPbPr (HD-15 or DVI-I via adapter), S-Video, Composite |
| Video Outputs | DVI-D |
| Weight | 8.8kg (300-001-168) 6.7kg (300-001-158) |



300-001-232
Radiance 32" HD Monitor

300-010-226
Radiance 27" HD Monitor

Technical data

| | |
|-------------------|---|
| Screen size | 32" / 27" diagonal |
| Resolution | 1920 x 1080 |
| Aspect ratio | 16:9 |
| Viewing angle | 178° |
| Numbers of colors | 1.07 Billion (10-bit) |
| Video Inputs | DVI-I and 3G-SDI Input/Output |
| Video Outputs | DVI-D |
| Weight | 11.0kg (300-001-232) 8.9kg (300-010-226) |



300-001-031
UHD 4K Monitor, 31"

Technical data

| | |
|---------------|--|
| Screen size | 31" diagonal |
| Resolution | 4096 x 2160 |
| Video Inputs | 1 x HDMI 2.0 1 x DP 1.2 (SST) & 1 x DP 1.2 (MST) 1 x DVI (single link) 4 x SDI (3G) |
| Video Outputs | 1 x DP 1.2 (SST) 1 x DVI (single link) 4 x SDI (3G) |
| Weight | 10.5kg |

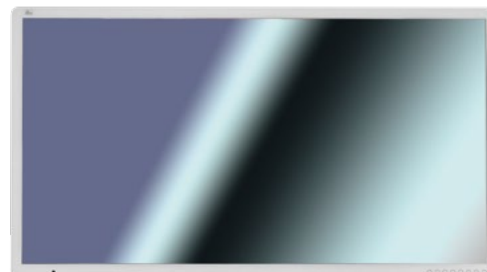

300-001-055
UHD 4K Monitor, 55"

Technical data

| | |
|-------------------|---|
| Screen size | 55" diagonal |
| Resolution | 3840 x 2160 |
| Aspect ratio | 16:9 |
| Viewing angle | 178° |
| Numbers of colors | 1.08 Billion (10-bit) |
| Video Inputs | 1 x HDMI 2.0, 2 x DP 1.2 (SST) 1 x DVI (single link), 2 x DVI (dual link) 4 x SOi (3G), 2 x SOi (12G) |
| Video Outputs | 1 x DVI (single link), 1 x DP 1.2 (SST) 4 x SDI (3G), 2x SDI (12G) |
| Weight | 37.35kg |

With the „Giuseppe“ Urology Resection Trainer, essential hand movements and techniques can be learned. With the specifically anatomical substrate, the ongoing surgeon can learn how to detect and remove pathological structures using the common resection procedures. The Urology Simulator helps convincing customers about the products at workshops, fairs or, thanks to the mobile design, directly at the customer's location.

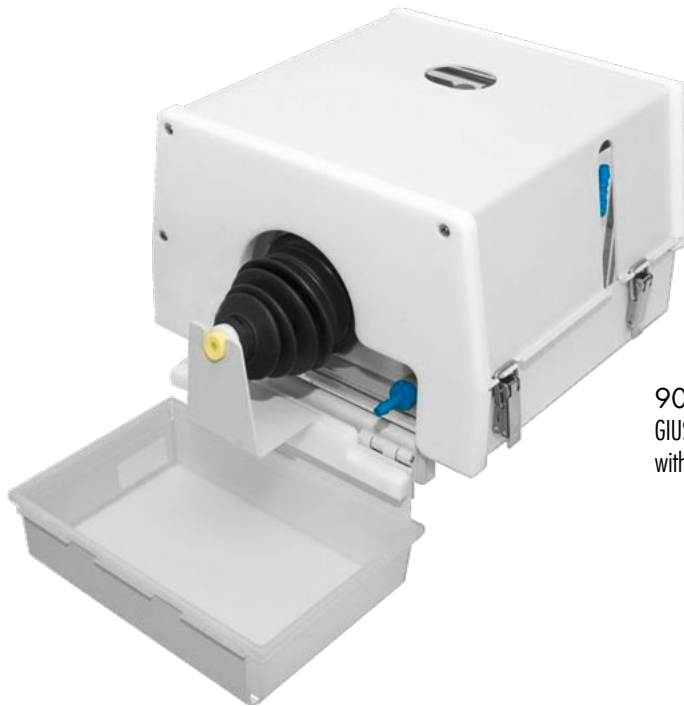

900-253-000
GIUSEPPE Urological Simulator / Trainer, prostate and bladder, incl. pump and accessories, without substrates

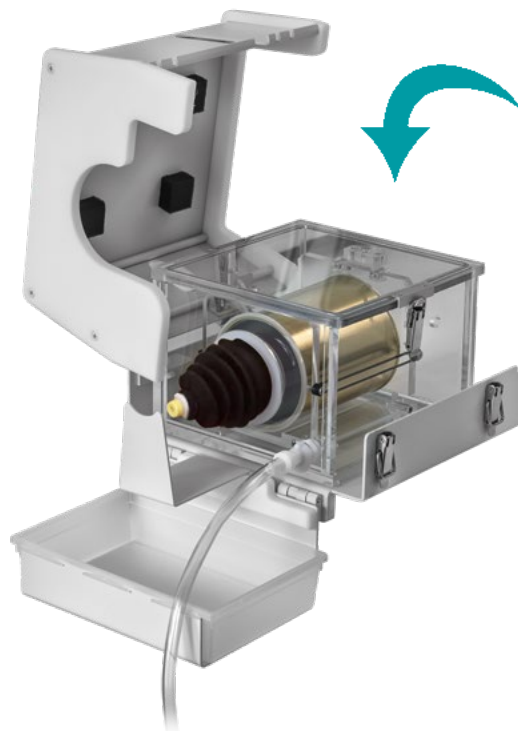
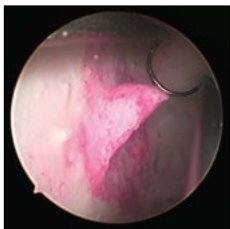
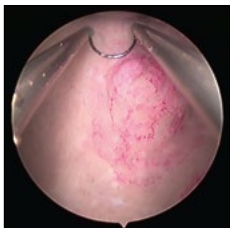

Urological Substrate with anatomical structures

- Realistic tissue
- Myomas and Polyps structures
- Close to reality environment

| Order-No. | Quantity | storable for |
|----------------|----------|--------------|
| 900-253-001* | 12 | 6 months |
| 900-253-002** | 6 | 3 months |
| 900-253-003*** | 12 | 12 months |

* anatomical structure of prostate

** anatomical structure of bladder

*** without anatomical structure



EQUIPMENT

Notes

| | |
|------|--|
| 10 | |
| 250 | |
| - | |
| 240 | |
| - | |
| 230 | |
| - | |
| 220 | |
| - | |
| 210 | |
| - | |
| 200 | |
| - | |
| 190 | |
| - | |
| 180 | |
| 7 | |
| - | |
| 170 | |
| - | |
| 160 | |
| - | |
| 150 | |
| - | |
| 140 | |
| - | |
| 130 | |
| 5 | |
| - | |
| 120 | |
| - | |
| 110 | |
| - | |
| 100 | |
| 4 | |
| - | |
| 90 | |
| - | |
| 80 | |
| 3 | |
| - | |
| 70 | |
| - | |
| 60 | |
| - | |
| 50 | |
| 2 | |
| - | |
| 40 | |
| - | |
| 30 | |
| 1 | |
| - | |
| 20 | |
| - | |
| 10 | |
| - | |
| INCH | |
| MM | |

VASECTOMY

Vasectomy is the only permanent method of contraception for men. It's safe, simple and effective and is the worldwide recommended family planning method for men who want a permanent solution to their contraceptive needs.

Vasectomy is a surgical procedure which seals the sperm carrying tubes (vas deferens), preventing sperm penetrating into the ejaculated fluid.

Currently there are only two contraceptive options available for men: - condoms and vasectomy. Men whose family planning is completed, may want to consider undergoing a vasectomy. Any man who has doubts about having children, ought not consider this procedure because it is a permanent method.

Many myths existing about vasectomy. Some men are afraid of a painful and complicated procedure. The truth is, that the operation takes around five minutes and can be carried out under local anaesthesia.

A recent international survey conducted by Mary Stopes is showing that 90% of vasectomy patients want to encourage other men to choose the same procedure.

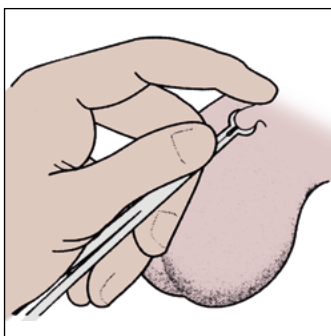

Puncture of the scrotal skin by using the RZ – Vasectomy Forceps

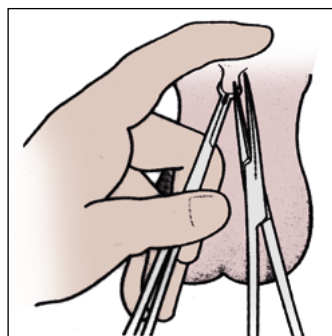

Fixation of the vas under the scrotal skin using the RZ – Vasectomy ring forceps

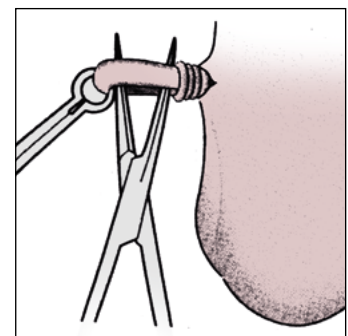

Dissecting blood vessel and sheath of vas prior to division and ligature or cauterization of the lumen



140-353-125
No-Scalpel Vasectomy Forceps, 5 inch, with sharp, pointed, smooth curved jaw

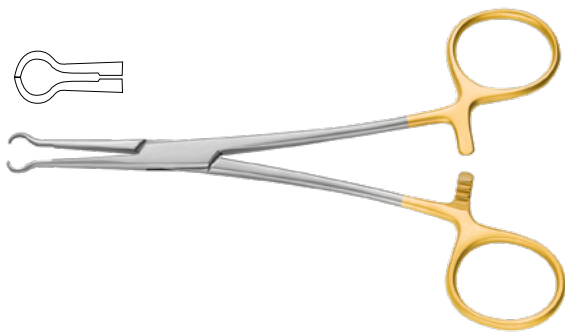

140-352-140
No-Scalpel Vasectomy Fixator Ring Forceps, 5^{1/2} inch, with blunt tips, ø 4.7 mm ring size



140-353-140
No-Scalpel Vasectomy Mini Fixator Ring Forceps, 5^{1/2} inch, with blunt tips, ø 3.0 mm ring size

BiPOstyle Bipolar Scissors and Forceps

RZ Micro Scissors are especially made for precise cutting when it comes to highly delicate surgery. Its thin scissors blades are a major advantage e.g. for plastic and reconstructive surgery.

combining the reliable mechanical pressure with the thermal effect of high frequency surgery to seal the vessel and tissue structures permanently.

RZ BiPOstyle clamps and forceps allow

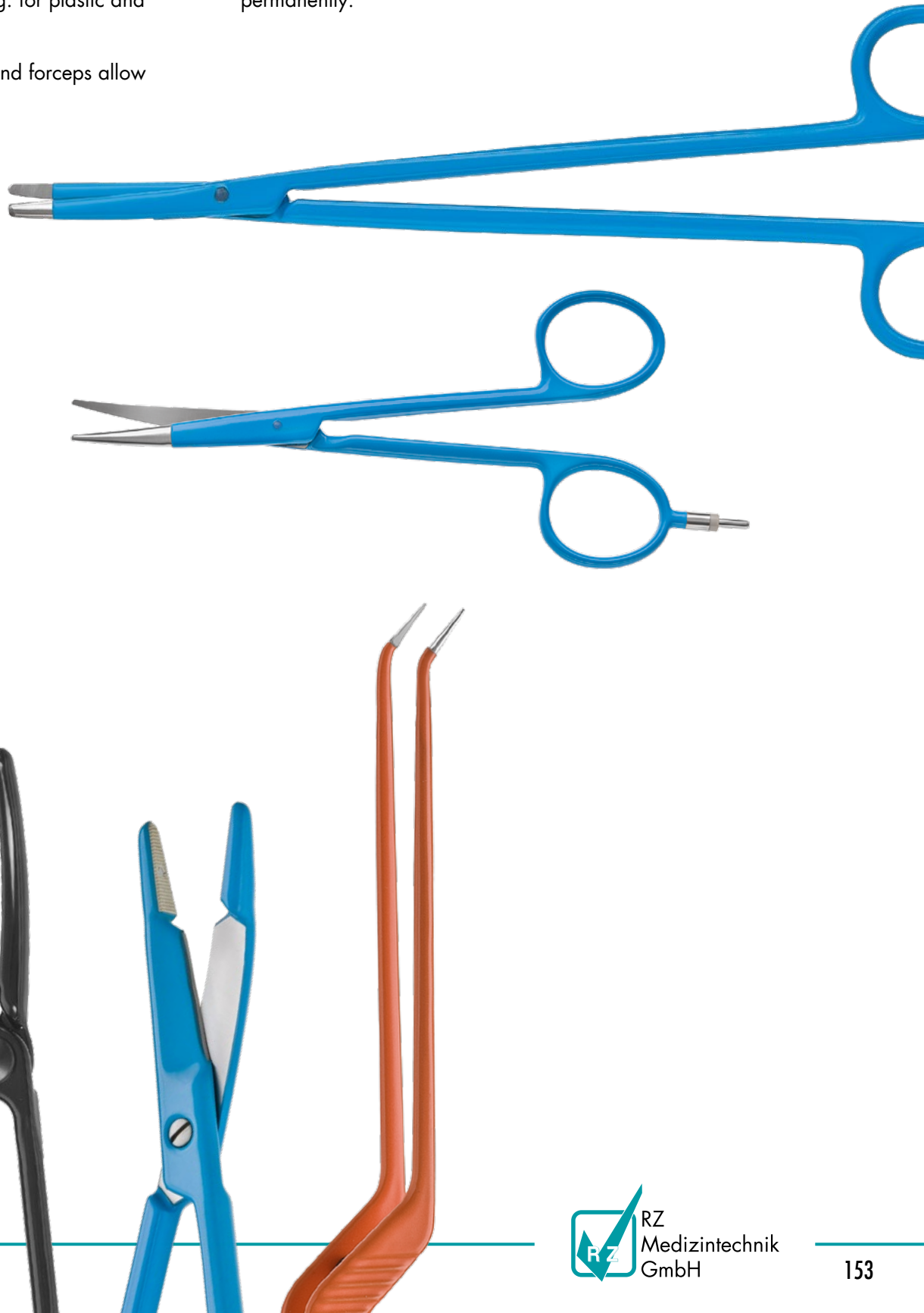

BIPOLAR SCISSORS for highly precise working



Ceramic coating



Single plug



- 120-742-130 130mm, 5"
 - 120-742-140 140mm, 5 1/2"
 - 120-742-175 175mm, 7"
- Micro Blade, curved

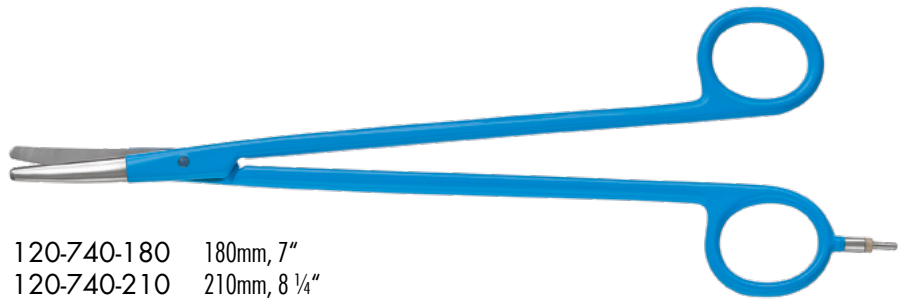

- 120-740-180 180mm, 7"
 - 120-740-210 210mm, 8 1/4"
 - 120-740-230 230mm, 9"
 - 120-740-280 280mm, 11"
- Standard blade, curved

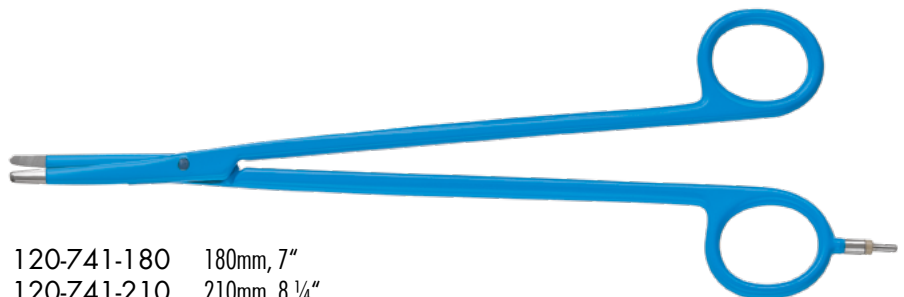

- 120-741-180 180mm, 7"
 - 120-741-210 210mm, 8 1/4"
 - 120-741-230 230mm, 9"
 - 120-741-280 280mm, 11"
- Delicate blade, curved

STANDARD BIPOLAR SCISSORS



Standard blades



Ethicon plug



120-743-130 130mm, 5"
Micro Blade, curved

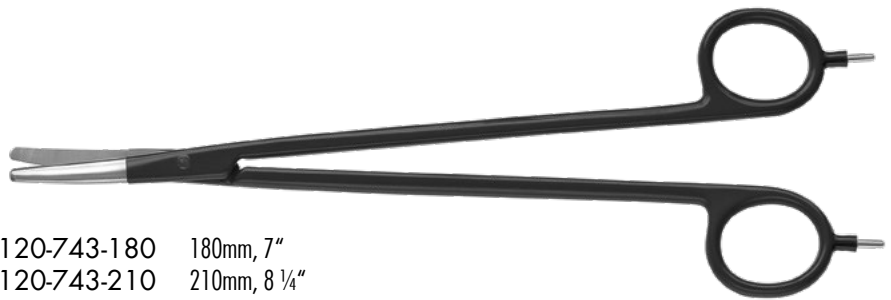

120-743-180 180mm, 7"
120-743-210 210mm, 8 1/4"
120-743-230 230mm, 9"
120-743-280 280mm, 11"
Standard blade, curved

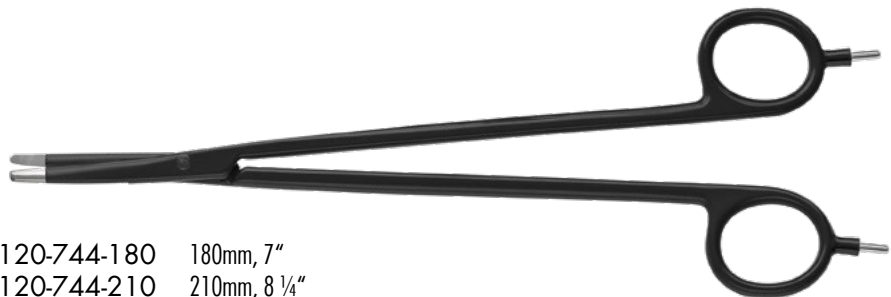

120-744-180 180mm, 7"
120-744-210 210mm, 8 1/4"
120-744-230 230mm, 9"
120-744-280 280mm, 11"
Delicate blade, curved



700-730-230 RZ Bipolar Clamp, curved jaws, 230mm, 9"



700-731-500 Bipolar Cable for RZ Bipolar Clamp, with 2 banana plugs, 5m length, not available with CE marking within Europe

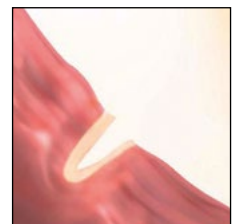
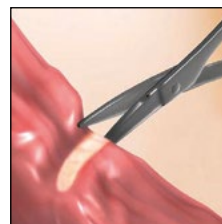
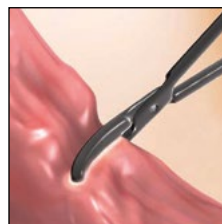
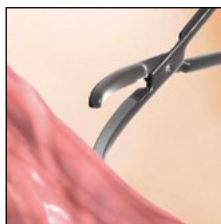

This special bipolar forceps is a combination of a thermal effect, obtained due to the use of especially modulated high frequency current with a mechanical pressure of the clamps. The result is a permanent sealing of the vessel membranes and tissue structures. The vessel can easily be cut with the use of surgical

scissors without the risk of bleeding. Vessels closed with the use of the RZ system are capable of withstanding significant pressure. The safety of the closure with the use of the RZ system is comparable to the one obtained with the use of other mechanical methods.



The RZ bipolar scissors-forceps enables powerful grasping and compression of tissue, combined with bipolar coagulation or sealing of blood vessels. Now, tissue can be cut without changing the instrument.



700-120-190 RZ bipolar scissors-forceps, straight, with serrated jaws, without ratchet, 19.0 cm, 7 1/2"
 700-120-140 RZ bipolar scissors-forceps, straight, with serrated jaws, without ratchet, 14.0 cm, 5 1/2"



700-121-190 RZ bipolar scissors-forceps, **curved**, with serrated jaws, without ratchet, 19.0 cm, 7 1/2"
 700-121-140 RZ bipolar scissors-forceps, **curved**, with serrated jaws, without ratchet, 14.0 cm, 5 1/2"

Perfect thermal conductivity with the RZ Bipolar Non-Stick Forceps

By using a polished noble material with excellent thermal properties for the forceps' tip, the undesirable effect of sticking tissue is now completely eliminated and non-stop working is ensured.

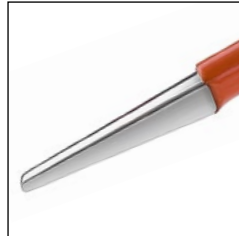

The polished noble metal forceps' tips offer excellent thermal conductivity which prevents the sticking of tissue. The non-stick effect is permanently ensured, as the tips are made of solid noble metal. Even after redressing the surface and frequent sterilisation, the non-sticking properties will be retained.

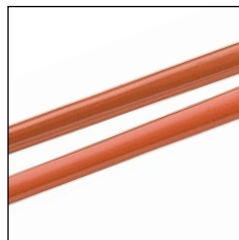

The resistant and well-proven insulation coating resists principally every highly alkaline cleaning agents. This ensures the electrical safety of the instrument reliably.



A wide fluted handle surface for safe and convenient handling ensures working without getting tired. Except the tips, the entire instrument is made of hardened stainless steel. This ensures a consistent optimum spring tension.

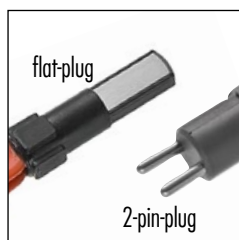

The plastic safety plugs enclose the complete connection area, even between the contact surfaces, in order to avoid the deposit of impurities in areas which are difficult to access for cleaning. All forceps are available with flat-plug or 2-pin-plug (2-pin-Standard).



| | | 150mm | 180mm | 200mm | 220mm |
|---------------|-------|---------------|-------------|---------------|-------------|
| Width of tips | Plug | straight tips | angled tips | straight tips | angled tips |
| point 0.3mm | flat | 700-610-150 | 700-611-150 | 700-610-180 | 700-611-180 |
| | 2-pin | 700-612-150 | 700-613-150 | 700-612-180 | 700-613-180 |
| blunt 0.6mm | flat | 700-620-150 | 700-621-150 | 700-620-180 | 700-621-180 |
| | 2-pin | 700-622-150 | 700-623-150 | 700-622-180 | 700-623-180 |
| blunt 1.0mm | flat | 700-630-150 | 700-631-150 | 700-630-180 | 700-631-180 |
| | 2-pin | 700-632-150 | 700-633-150 | 700-632-180 | 700-633-180 |
| blunt 2.0mm | flat | 700-640-150 | 700-641-150 | 700-640-180 | 700-641-180 |
| | 2-pin | 700-642-150 | 700-643-150 | 700-642-180 | 700-643-180 |



Jeweler Type

110mm

| Width of tips | Plug | straight tips | angled tips |
|---------------|-------|---------------|-------------|
| point 0.25mm | flat | 700-601-710 | 700-601-730 |
| | 2-pin | 700-601-711 | 700-601-731 |
| blunt 0.6mm | flat | 700-601-712 | 700-601-732 |
| | 2-pin | 700-601-713 | 700-601-733 |
| blunt 1.0mm | flat | 700-601-714 | 700-601-734 |
| | 2-pin | 700-601-715 | 700-601-735 |



straight tips

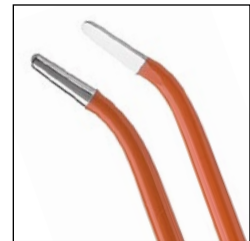

angled tips



Bayonet shape

180mm

200mm

220mm

240mm

| Width of tips | Plug | straight tips | straight tips | straight tips | straight tips |
|---------------|-------|---------------|---------------|---------------|---------------|
| point 0.3mm | flat | 700-650-180 | 700-650-200 | 700-650-220 | 700-650-240 |
| | 2-pin | 700-652-180 | 700-652-200 | 700-652-220 | 700-652-240 |
| blunt 0.6mm | flat | 700-660-180 | 700-660-200 | 700-660-220 | 700-660-240 |
| | 2-pin | 700-662-180 | 700-662-200 | 700-662-220 | 700-662-240 |
| blunt 1.0mm | flat | 700-670-180 | 700-670-200 | 700-670-220 | 700-670-240 |
| | 2-pin | 700-672-180 | 700-672-200 | 700-672-220 | 700-672-240 |
| blunt 2.0mm | flat | 700-680-180 | 700-680-200 | 700-680-220 | 700-680-240 |
| | 2-pin | 700-682-180 | 700-682-200 | 700-682-220 | 700-682-240 |

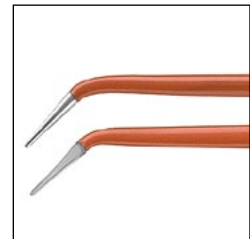

angled down

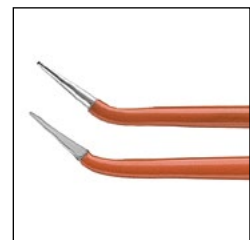

angled up

Bayonet shape

200mm

220mm

| Width of tips | Plug | angled up tips | angled up tips |
|---------------|-------|----------------|----------------|
| blunt 1.0mm | flat | 700-670-201 | 700-670-221 |
| | 2-pin | 700-672-201 | 700-672-221 |

Bayonet shape

200mm

220mm





| Width of tips | Plug | angled down tips | angled down tips |
|---------------|-------|------------------|------------------|
| blunt 1.0mm | flat | 700-670-203 | 700-670-223 |
| | 2-pin | 700-672-203 | 700-672-223 |



Bipolar Cables

| Generator end | | | | | | |
|---------------|-------------------------------|-----------|-------------------|-------------------|-------------|-------------|
| | | Flat plug | Flat plug, angled | Flat plug, square | 2-pin plug | |
| | 2-Banana * | 3m | 700-350-030 | 300-860-100 | 700-350-130 | 700-351-030 |
| | | 5m | 700-350-050 | 300-860-111 | 700-350-150 | 700-351-050 |
| | Erbe | 3m | 700-101-001 | 700-100-130 | 700-101-130 | 700-100-102 |
| | | 5m | 700-100-101 | 700-100-150 | 700-101-150 | 700-100-103 |
| | Martin, Aesculap Berchtold | 3m | 700-287-030 | 700-200-130 | 700-287-130 | 700-200-132 |
| | | 5m | 700-287-050 | 700-200-150 | 700-287-150 | 700-200-152 |
| | Valleylab Lamidey, EMC | 3m | 700-351-031 | 700-300-003 | 700-351-131 | 700-300-203 |
| | | 5m | 700-351-051 | 700-300-005 | 700-351-151 | 700-300-205 |

* Not available with CE marking within Europe

|  |  |  |  |  |  |  |
|---|---|---|---|---|---|---|
| 2-pin plug, angled | 2-pin plug, angled | Round plug | R. Wolf plug | Karl Storz plug | Ethicon Scissors plug | Aesculap plug |
| 700-345-403 700-345-405 | 700-345-003 700-345-005 | 700-739-003 700-739-005 | 700-630-003 | 700-351-047 700-351-048 | 700-351-053 700-351-055 | 700-200-030 700-200-050 |
| 700-101-230 700-101-250 | | 700-100-202 700-100-303 | 700-100-104 700-100-105 | 700-100-302 700-100-305 | 700-100-402 700-100-405 | 700-100-502 700-100-505 |
| 700-287-230 700-287-250 | | 700-200-232 700-200-253 | 700-390-030 700-390-050 | 700-200-332 700-200-352 | 700-200-432 700-200-452 | 700-200-532 700-200-552 |
| 700-351-231 700-351-251 | 700-300-403 700-300-405 | 700-736-003 700-736-005 | 700-300-503 700-300-505 | 700-300-603 | 700-300-703 700-300-705 | 700-300-805 |