



PROFILE

Nationality: Italian

Date of birth: April 19., 1976

Medical Degree: 2003
University of Palermo

Languages: Italian (native)
English

Consultant: Tokyo (2003)
Eritrea (2008)
Milano (2015)
Bergamo (present)

Present status:
Working for Policlinico Universitario
Paolo Giaccone di Palermo

Mentions:
Hysteroscopy Unit, Scientific Consultant of RZ Medizintechnik, developer of Rotating Hysteroscopy Instruments, Bipolar Resection Set and Accardi's Cold Knives.

Dr. Antonio Accardi

- Clinical and surgery formation in the most important Cancer Center of Italy, now collaboration with Gyn Onco department directed by Prof. Chiantera
- Hysteroscopic surgery formation in two of the most important Hysteroscopy schools of the world, learning the office surgery at Prof. Bettocchi, Endoscopy Department and resectoscopy at Prof. Mazzon Clinic
- Founder and chief of Hysteroscopy outpatient unit, Humanitas Cancer Center and Research Hospital, Milano, Italy
- Consultant for RZ Medizintechnik to develop and patent new instruments to improve Hysteroscopy
- Tutor, Teacher and Mentor for medical specialists who want to learn the Hysteroscopic technique
- 15 years of experience and expertise in the fields of Gynecology and Hysteroscopy



CONFIGURATIONS by RZ

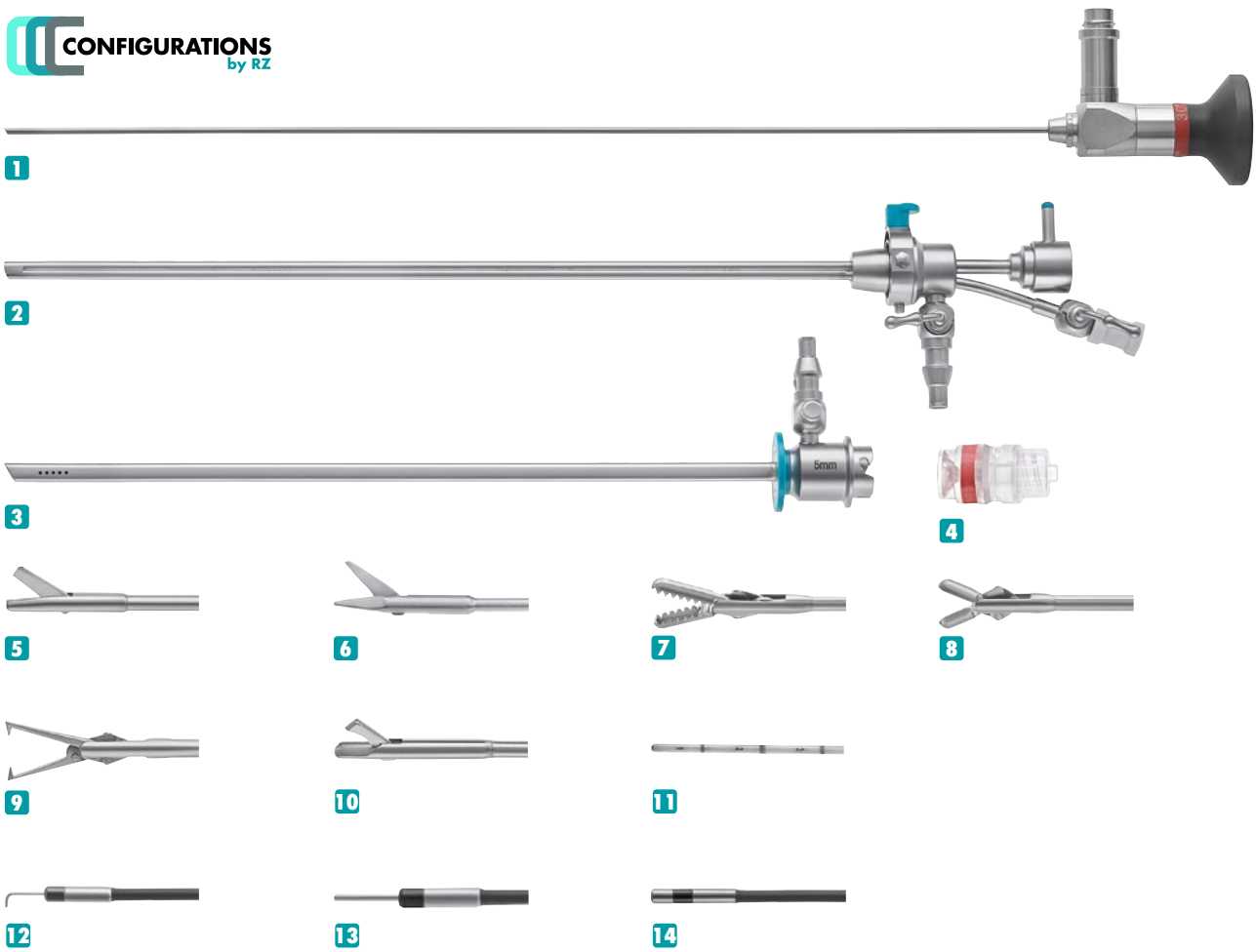

| | Article-No. | Description | Page | Qty. |
|-----------|-------------|---|------|--------|
| 1 | 351-829-030 | Midi Hysteroscope, \varnothing 2.9mm, 30° | 6 | 1 pc. |
| 2 | 351-400-143 | Operating Sheath, 5 Charr. | 8 | 1 pc. |
| 3 | 351-400-150 | Outer Sheath, \varnothing 5mm | 8 | 1 pc. |
| 4 | 351-905-105 | Disposable Silicon Valve, package with 10 pcs. | 13 | 1 pcs. |
| 5 | 351-100-305 | 5 Charr. semi-rigid Scissors, blunt, 400mm working length | 15 | 1 pc. |
| 6 | 351-118-305 | 5 Charr. semi-rigid Scissors, sharp, 400mm working length | 15 | 1 pc. |
| 7 | 351-116-305 | 5 Charr. semi-rigid Grasping Forceps, 400mm working length | 15 | 1 pc. |
| 8 | 351-120-305 | 5 Charr. semi-rigid Biopsy Forceps, 400mm working length | 15 | 1 pc. |
| 9 | 351-117-305 | 5 Charr. semi-rigid Tenaculum Forceps, 400mm working length | 15 | 1 pc. |
| 10 | 351-126-305 | 5 Charr. semi-rigid Biopsy Punch Forceps, 400mm working length | 15 | 1 pc. |
| 11 | 351-125-105 | 5 Charr. Palpation Probe, 400mm working length | 17 | 1 pc. |
| 12 | 351-360-015 | 5 Charr. Bipolar Needle Electrode, 90°, 360mm working length | 18 | 1 pc. |
| 13 | 351-360-005 | 5 Charr. Bipolar Needle Electrode, straight, 360mm working length | 18 | 1 pc. |
| 14 | 351-370-105 | 5 Charr. Bipolar Ball Electrode, 360mm working length | 18 | 1 pc. |



| | Article-No. | Description | Page | Qty. |
|-----------|-------------|-----------------------------------|------|--------|
| 1 | 351-100-200 | Basic Irrigation Pump P1 | 58 | 1 pc. |
| 2 | 300-001-804 | 3-Chip HD Camera F4 | 64 | 1 pc. |
| 3 | 300-001-813 | TV-Coupler, f=14mm | 69 | 1 pc. |
| 4 | 300-010-226 | 27" Radiance Monitor | 70 | 1 pcs. |
| 5 | 300-900-180 | LUMEN LED 1 Light Source | 74 | 1 pc. |
| 6 | 250-035-230 | Fiber Optic Light Cable, 2300mm | 75 | 1 pc. |
| 7 | 250-039-000 | Adapter RZ/Storz | 75 | 1 pc. |
| 8 | 250-042-000 | Adapter RZ/Storz/Olympus | 75 | 1 pc. |
| 9 | 300-001-999 | RZ Trolley | - | 1 pc. |
| 10 | 700-340-400 | Highfrequency Generator G44, 230V | 78 | 1 pc. |



Mini Diagnostic Hysteroscope Set Ø 2mm

For many years Hysteroscopy was not the first choice procedure for Gynaecologists as instruments had a big diameter and a painful dilation of the cervical channel was necessary. Now, RZ Medizintechnik GmbH offers a Mini-Diagnostic Hysteroscope and Operative Set. Our real Hysteroscopes ensure a long life-time of smallest endoscopes, making Hysteroscopy a fast, safe and cost-effective procedure in Gynecology.

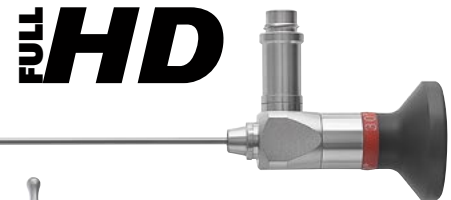
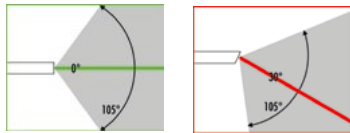

Mini-Hysteroscope, Ø 2.0mm, working length: 260mm, overall length: 315mm
 351-720-000 0°
 351-720-030 30°

Diagnostic sheath for 2.0mm Hysteroscope, including obturator, Ø 2.9mm, working length: 228mm

1:1
 351-720-200 for 0° Hysteroscope

1:1
 351-720-300 for 30° Hysteroscope



Continuous-Flow Mini Diagnostic sheaths without working channel

351-720-500
 Diagnostic sheath, Ø 2.9mm, 218mm working length, with inflow stopcock, including obturator, for use with outer sheath 351-720-600 and Mini Hysteroscope 351-720-030

351-720-600
 Outer sheath, Ø 3.7mm, 200mm working length, with outflow stopcock, for use with diagnostic sheath 351-720-500

Mini Operating Hysteroscope Set Ø 2mm



Continuous-Flow Mini Operating sheaths with working channel

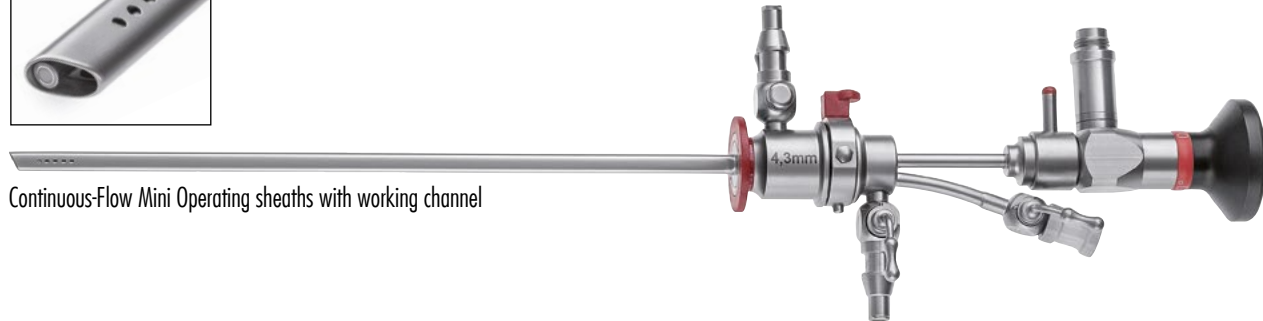

351-720-550

Operating sheath, with working channel for use with 5 Charr. instruments, with inflow stopcock, for use with outer sheath 351-720-650 and Mini Hysteroscope 351-720-030



351-720-650

Outer sheath, Ø 4.3mm, oval shape, 192mm working length, with outflow stopcock, for use with operating sheath 351-720-550

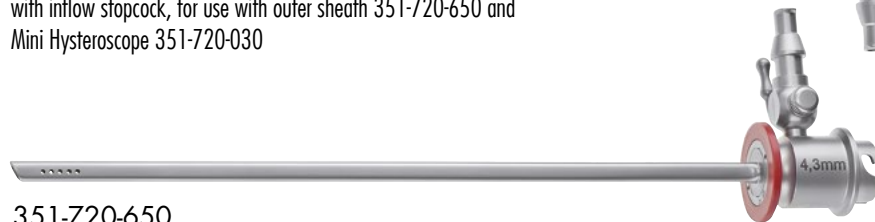

351-400-040

Compact Continuous-Flow sheath, Ø 4.3mm, oval shape, working length: 170mm, with working channel for use with 5 Charr. instruments and 2 stopcocks for inflow and outflow for use with Mini Hysteroscope 351-720-030

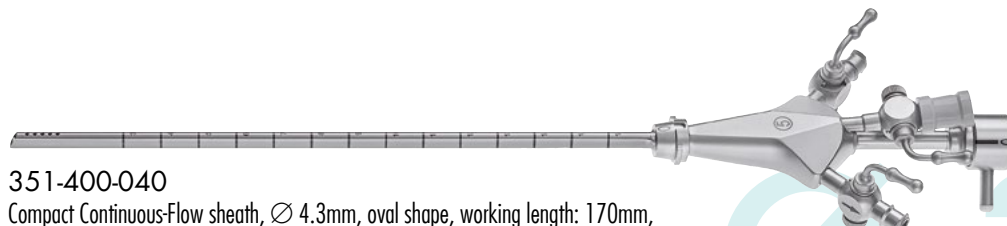

Ø 2mm



Midi Diagnostic Hysteroscope Set Ø 2.9mm

FULL HD



Rigid Rod Lens Midi Hysteroscope

351-829-000 Midi Hysteroscope, Ø 2.9mm, 0° direction of view, 300mm working length, overall length: 355mm

351-829-030 Midi Hysteroscope, Ø 2.9mm, 30° direction of view, 300mm working length, overall length: 355mm

Midi diagnostic sheaths

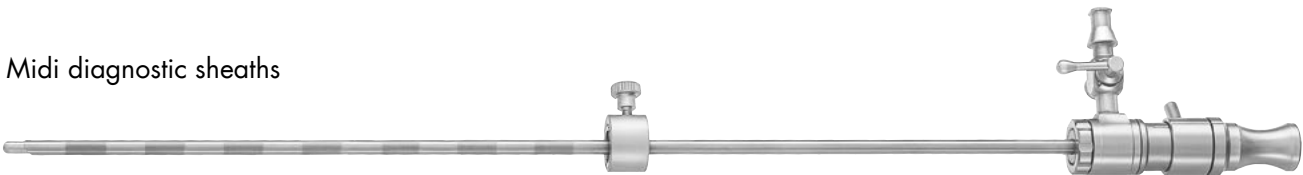

351-230-040

Diagnostic sheath, Ø 4.0mm, 270mm working length, with rotating stopcock, including obturator and distance holder, for use with 351-829-030 or 351-829-130



Diagnostic Sheath, Ø 4.0mm, 270mm working length, with rotating stopcock, including obturator

 1:1
351-300-040 for 0° Hysteroscope

 1:1
351-330-040 for 30° Hysteroscope

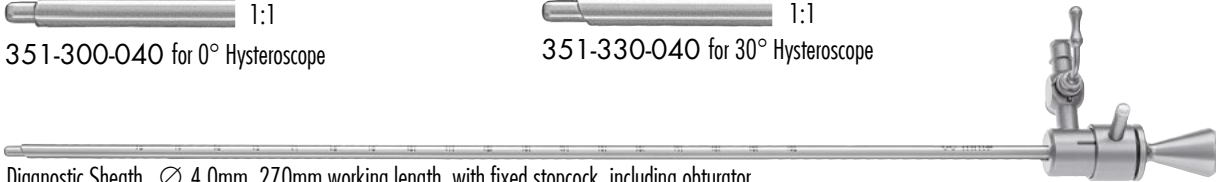

Diagnostic Sheath, Ø 4.0mm, 270mm working length, with fixed stopcock, including obturator, recommended for **CO₂ gas dilation**

 1:1
351-500-040 for 0° Hysteroscope

 1:1
351-530-040 for 30° Hysteroscope

Continuous-Flow Midi Diagnostic sheaths without working channel

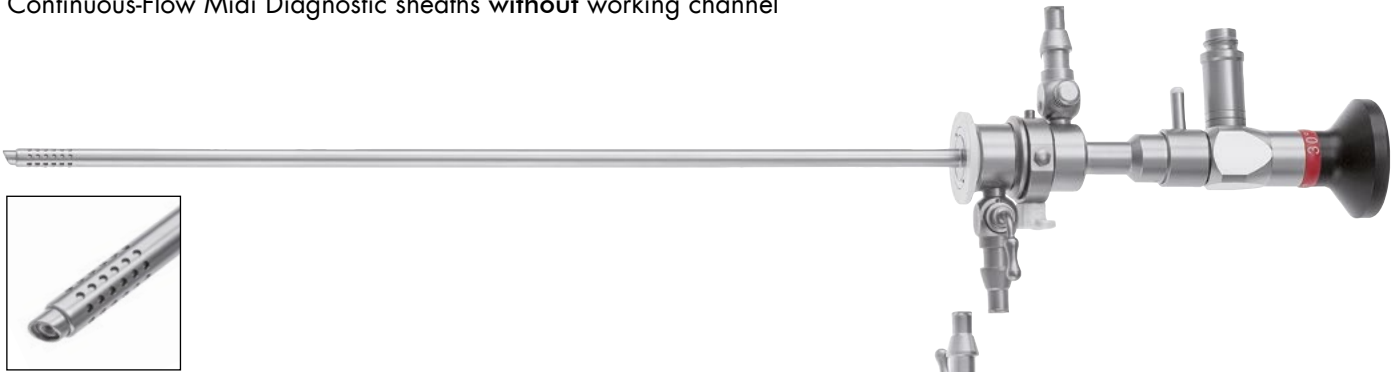

351-300-037

Diagnostic sheath, Ø 4.0mm, 267mm working length, with inflow stopcock, including obturator, for use with outer sheath 351-300-050 and Midi Hysteroscope 351-829-030 or 351-829-130

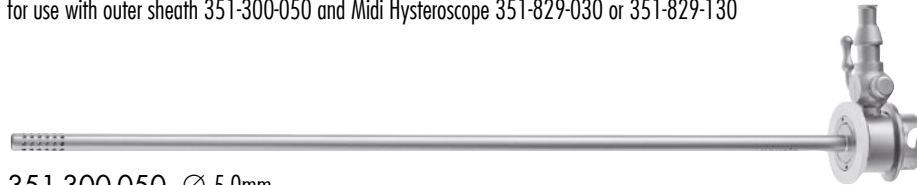

351-300-050 Ø 5.0mm

Outer sheath, 240mm working length, with outflow stopcock, for use with diagnostic sheath 351-300-037

Midi Operating Hysteroscope Sheath Ø 2.9mm



351-400-037

Operating sheath, with working channel for use with 5 Charr. instruments, Ø 5mm, pear-shaped sheath, 248mm working length, with inflow and outflow stopcock, for use with 351-829-030 or 351-829-130

Ø 2.9mm

Midi Operating Hysteroscope Set Ø 2.9mm

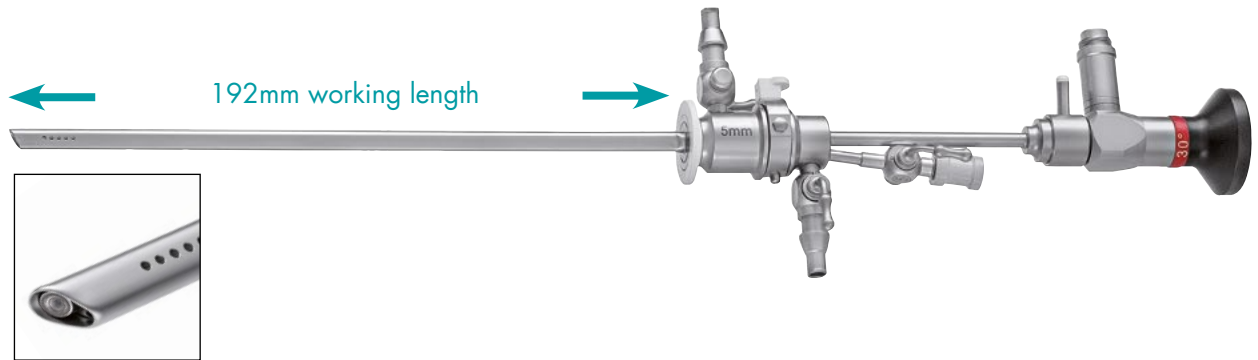

351-400-043

Operating Sheath, with working channel for use with 5 Charr. instruments, with inflow stopcock, for use with outer sheath 351-400-050 and Midi Hysteroscope 351-829-030 or 351-829-130

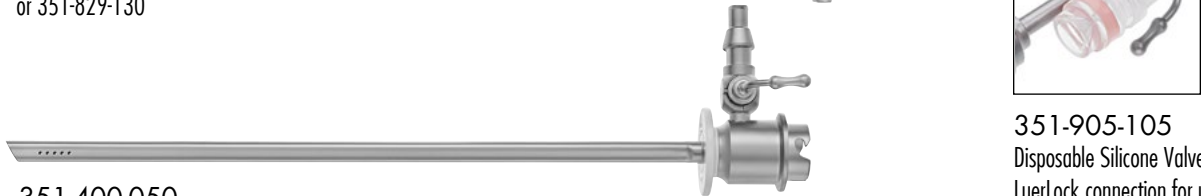

351-400-050

Outer Sheath, Ø 5.0mm, pear-shaped sheath, 192mm working length, with outflow stopcock, for use with operating sheath 351-400-043

351-905-105
Disposable Silicone Valve with LuerLock connection for use with 3 - 10 Charr. instruments sterile packed, package with 10 pieces

EXTENDED working length

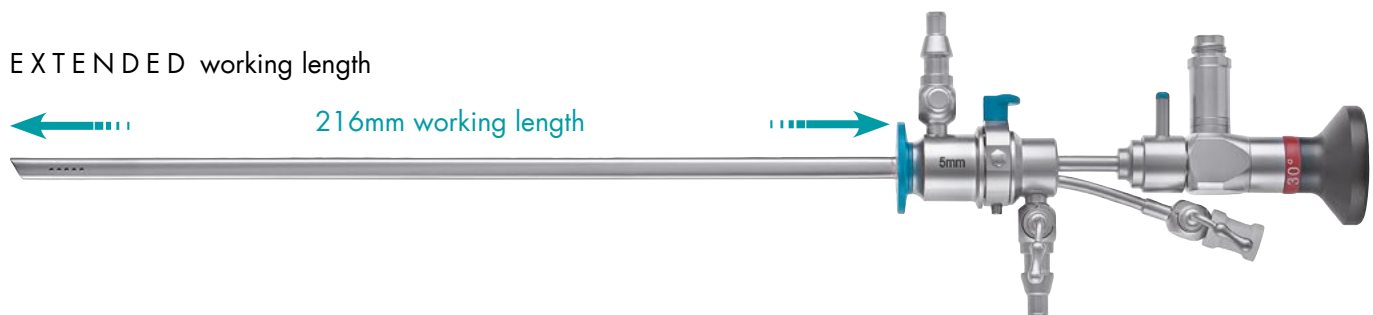

351-400-143

Operating Sheath, with working channel for use with 5 Charr. instruments, with inflow stopcock, for use with outer sheath 351-400-150 and Midi Hysteroscope 351-829-030 or 351-829-130

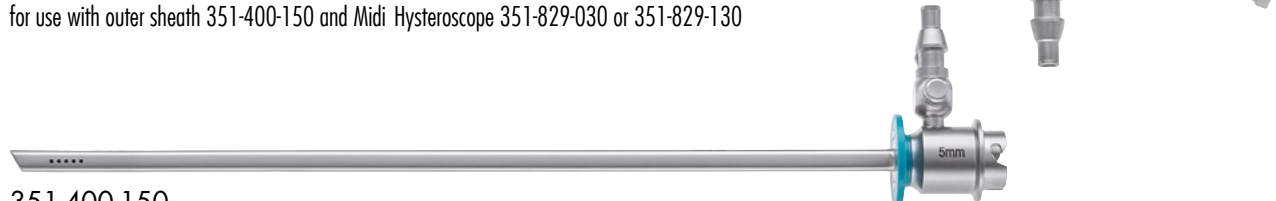

351-400-150

Outer Sheath, Ø 5.0mm, pear-shaped sheath, 216mm working length, with outflow stopcock, for use with operating sheath 351-400-143



HYSTEROSCOPY

Ø 2.9mm Midi Operating
Hysteroscope

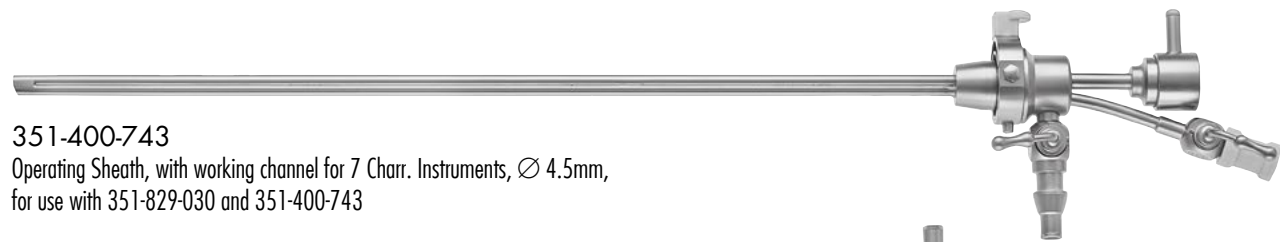
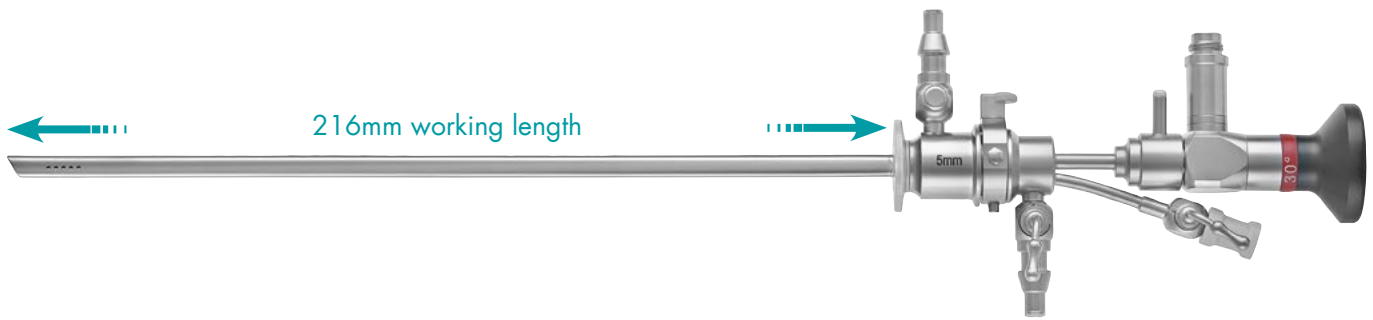

351-400-743
Operating Sheath, with working channel for 7 Charr. Instruments, Ø 4.5mm,
for use with 351-829-030 and 351-400-743



351-400-750
Outer Sheath, Ø 5.0mm, 216mm working length,
for use with 351-829-030 and 351-400-750

Ø 2.9mm

Midi Operating Compact Hysteroscope Set Ø 2.9mm

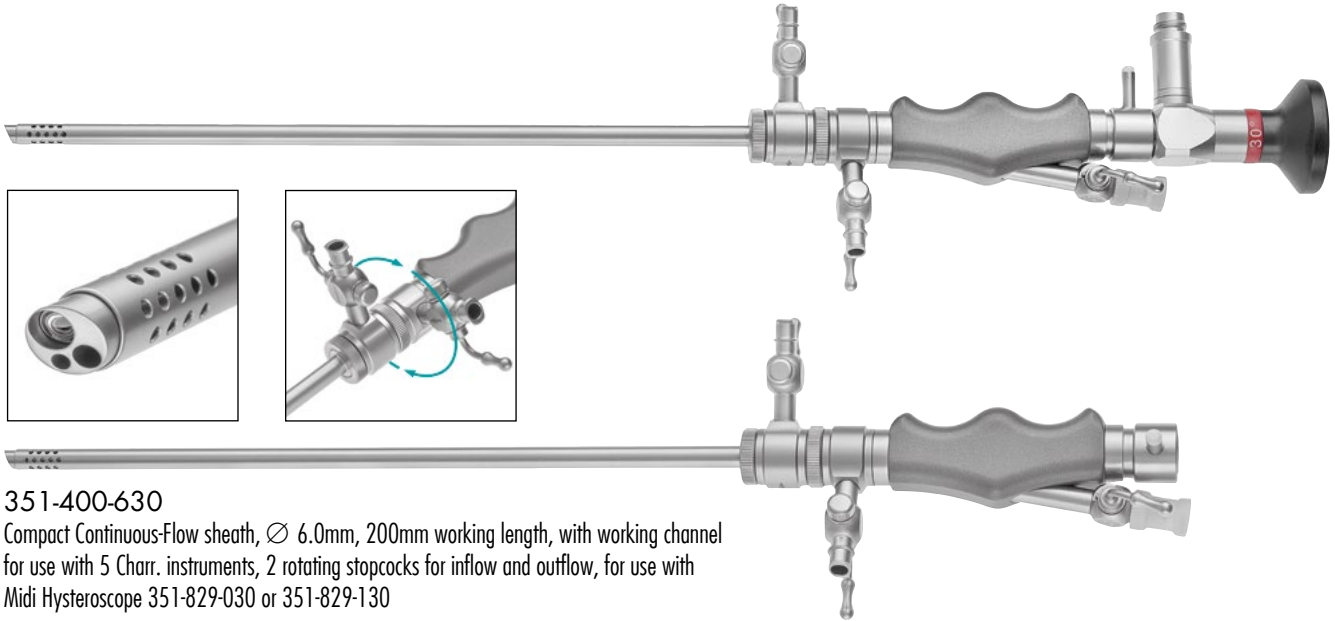

351-400-630

Compact Continuous-Flow sheath, Ø 6.0mm, 200mm working length, with working channel for use with 5 Charr. instruments, 2 rotating stopcocks for inflow and outflow, for use with Midi Hysteroscope 351-829-030 or 351-829-130

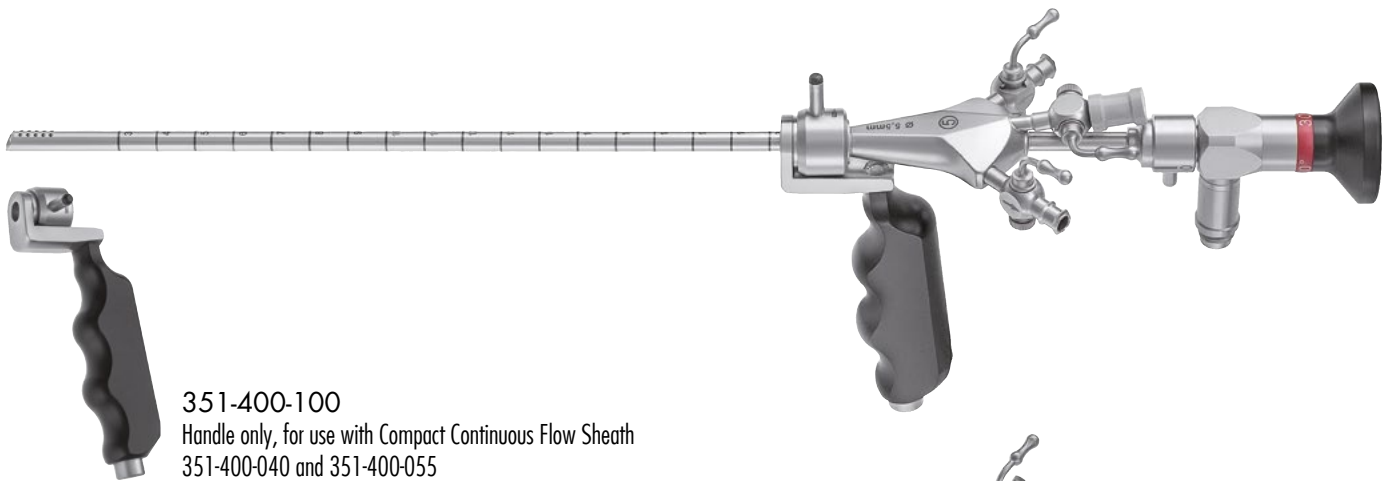

351-400-100

Handle only, for use with Compact Continuous Flow Sheath 351-400-040 and 351-400-055

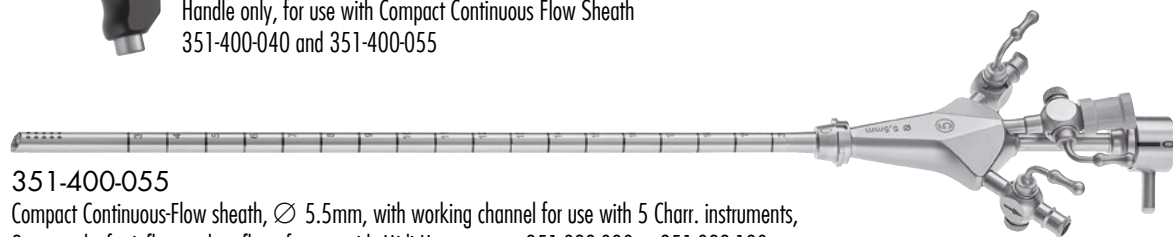

351-400-055

Compact Continuous-Flow sheath, Ø 5.5mm, with working channel for use with 5 Charr. instruments, 2 stopcocks for inflow and outflow, for use with Midi Hysteroscope 351-829-030 or 351-829-130

Ø 2.9mm

Grand Diagnostic Hysteroscope Set ∅ 4mm

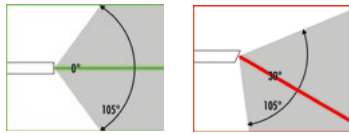

Hysteroscopes, ∅ 4.0mm, 300mm working length, overall length: 355mm

- 351-804-000 0°
- 351-804-030 30°

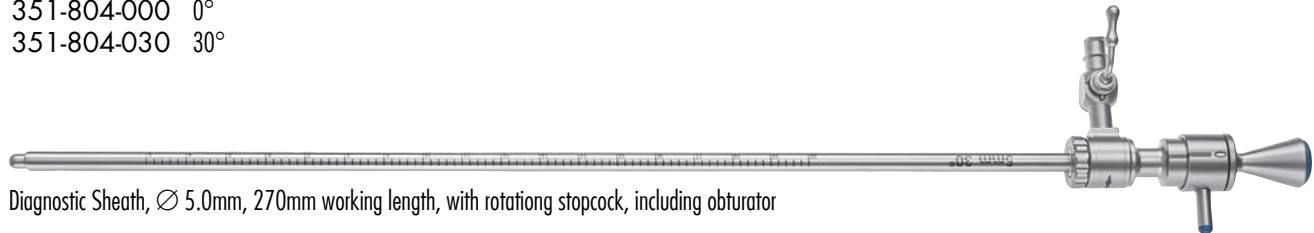

Diagnostic Sheath, ∅ 5.0mm, 270mm working length, with rotating stopcock, including obturator



1:1

351-500-050 for 0° Hysteroscope



1:1

351-530-050 for 30° Hysteroscope

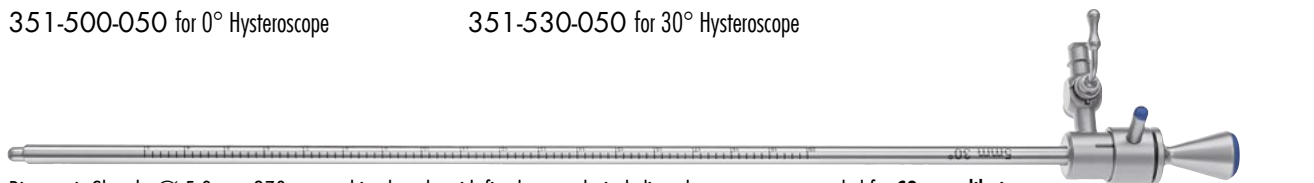

Diagnostic Sheath, ∅ 5.0mm, 270mm working length, with fixed stopcock, including obturator, recommended for CO₂ gas dilation



1:1

351-630-050 for 30° Hysteroscope

Continuous-Flow Diagnostic sheaths without working channel

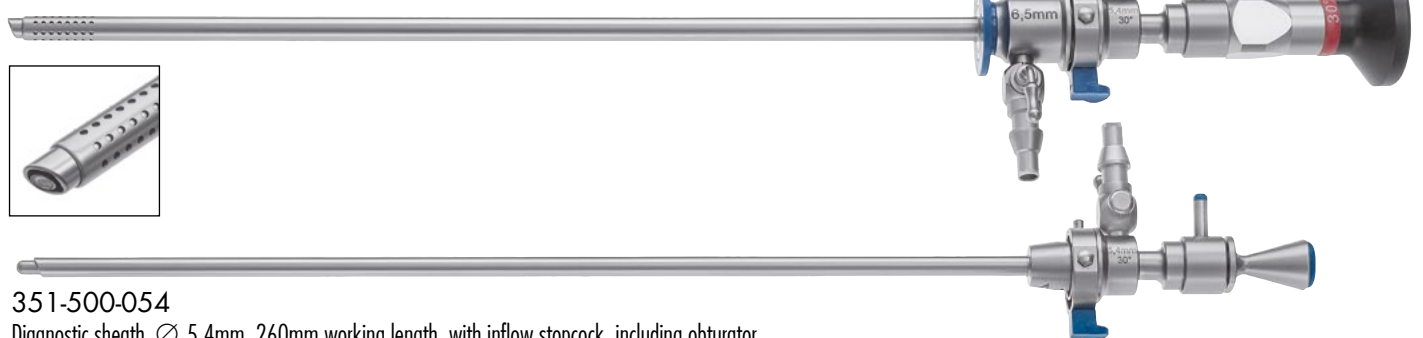

351-500-054

Diagnostic sheath, ∅ 5.4mm, 260mm working length, with inflow stopcock, including obturator, for use with outer sheath 351-500-065 and Hysteroscope 351-804-030

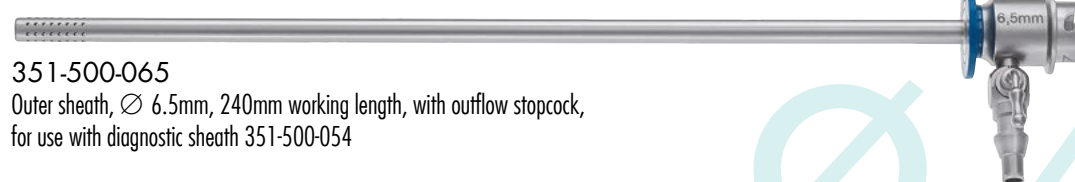

351-500-065

Outer sheath, ∅ 6.5mm, 240mm working length, with outflow stopcock, for use with diagnostic sheath 351-500-054

∅ 4mm

Grand Operating Hysteroscope Set ∅ 4mm

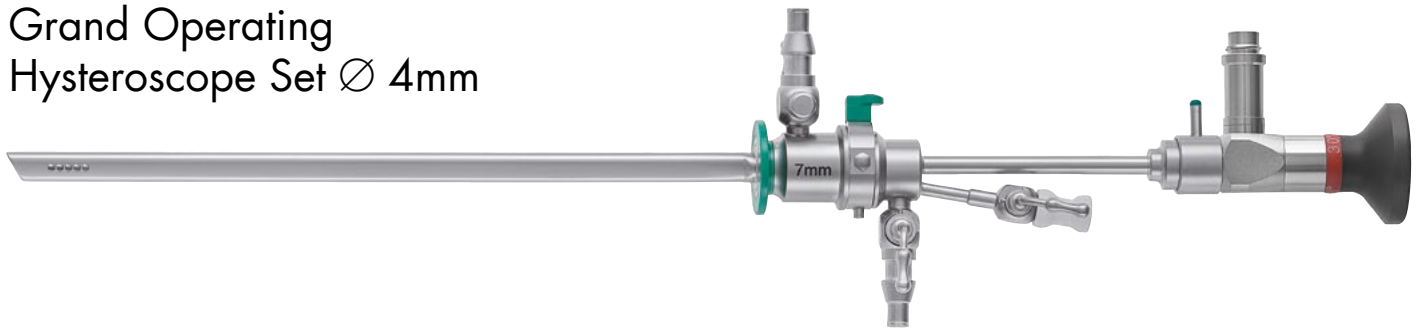

351-500-170
Operating sheath, with working channel for use with 7 Charr. instruments, with inflow stopcock,
for use with outer sheath 351-500-070 and Hysteroscope 351-804-030



351-500-070
Outer sheath, ∅ 7.0mm, pear-shaped sheath, 192mm working length, with outflow stopcock,
for use with operating sheath 351-500-170

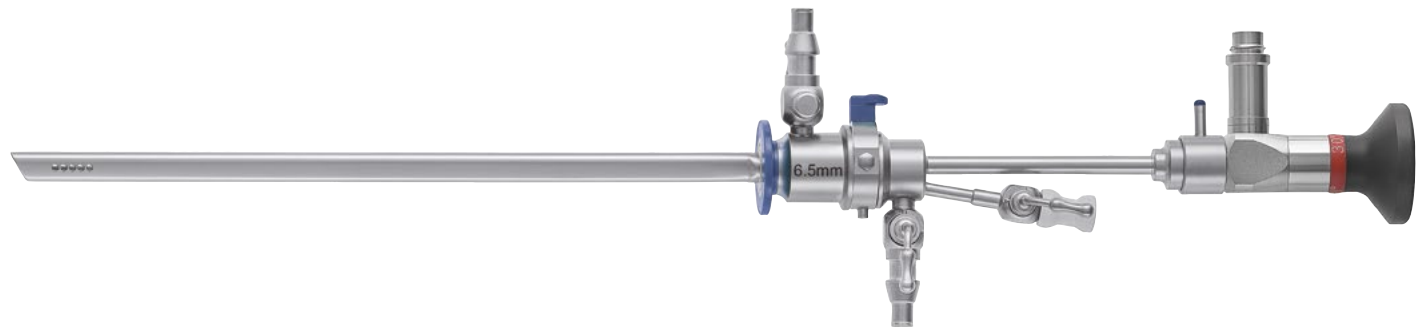
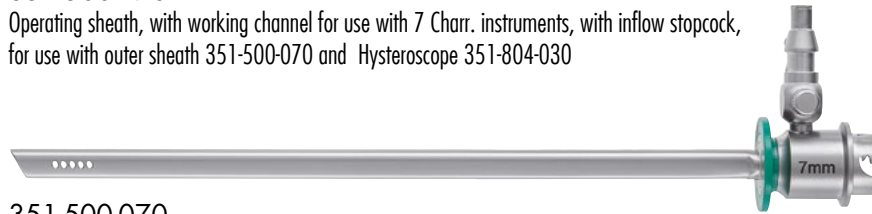

351-500-160
Operating sheath, with working channel for use with 5 Charr. instruments, with inflow stopcock,
for use with outer sheath 351-500-060 and Hysteroscope 351-804-030



351-500-060
Outer sheath, ∅ 6.5mm, pear-shaped sheath, 192mm working length, with outflow stopcock,
for use with operating sheath 351-500-160

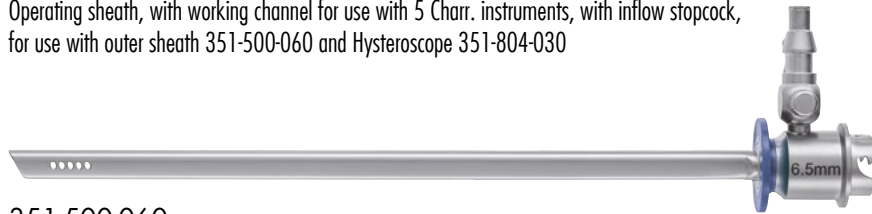

∅ 4mm



300-011-181
LuerLock tube
connector 9mm



300-011-506
LuerLock tube
connector 6mm



300-011-184
LuerLock Tuohy
Borst Adapter

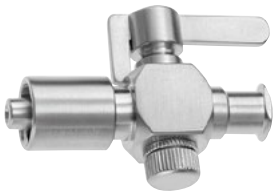

300-011-178
LuerLock one-way stop-cock
with spring screw cap



300-011-179
LuerLock tube connector with stopcock



300-011-506
Luer-Lock tube connector



301-701-100
Grey Rubber cap for use
on all working channels



351-905-105
Disposable Silicone Valve with
LuerLock connection for use
with 3 - 10 Charr. instruments
sterile packed,
package with 10 pieces



351-905-110
Silicone Valve, reusable,
for instruments up to $\varnothing 1.8\text{mm}$ (5.5Charr.)
with LL-Connection,
10pcs. per package

360° rotating and color coded instruments, 5 Charr.

The unique design and features of the rotating color coded instruments have been designed in cooperation with Dr Accardi. Multiple years of experience in using dedicated instruments have led to this design and functionality.

The automatic holding mechanism combined with the 360° rotation of the jaw and the light design will improve your comfort.

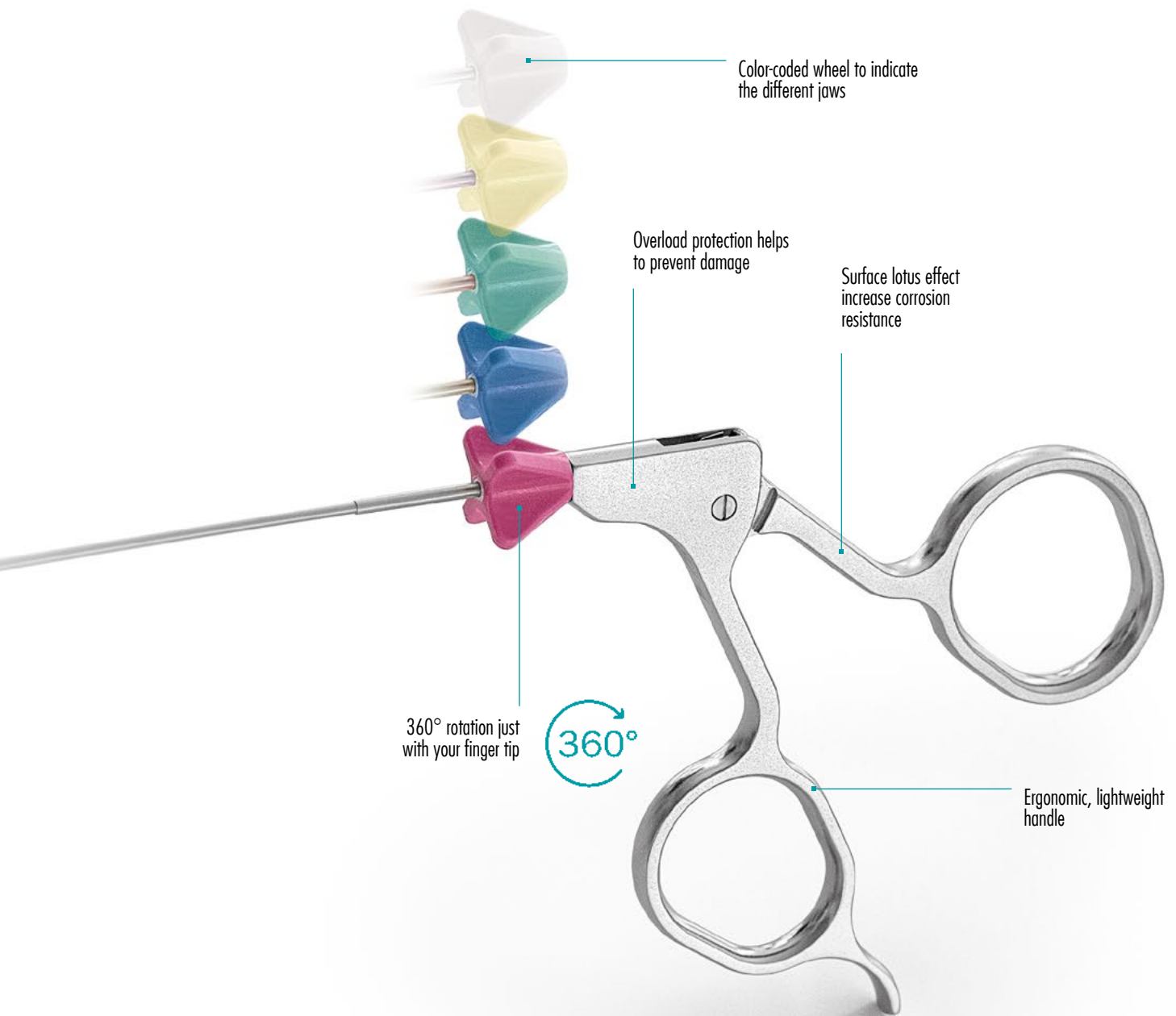

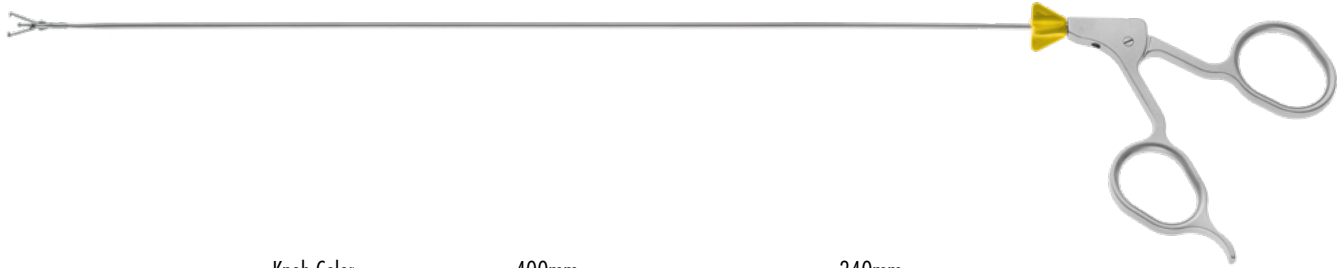

| | Knob Color | 400mm | 340mm | |
|--|------------|-------------|-------------|--|
| | | 351-116-305 | 351-116-335 | Grasping Forceps with cup, serrated, double action |
| | | 351-118-305 | 351-118-335 | Scissors, sharp tips, single action |
| | | 351-100-305 | 351-100-335 | Scissors, blunt tips, single action |
| | | 351-126-305 | 351-126-335 | Biopsy Punch Forceps, single action |
| | | 351-120-305 | 351-120-335 | Biopsy Forceps, double action |
| | | 351-117-305 | 351-117-335 | Tenaculum Forceps, 1x1 teeth, double action |
| | | 351-115-305 | 351-115-335 | SHARK Tenaculum Grasping Forceps |
| | | 351-119-305 | 351-119-335 | Accardi HARPOON Grasping Forceps, with barbs |

6 Charr. flexible insulated Hysteroscopy Instruments for use with 7 Charr. working channel

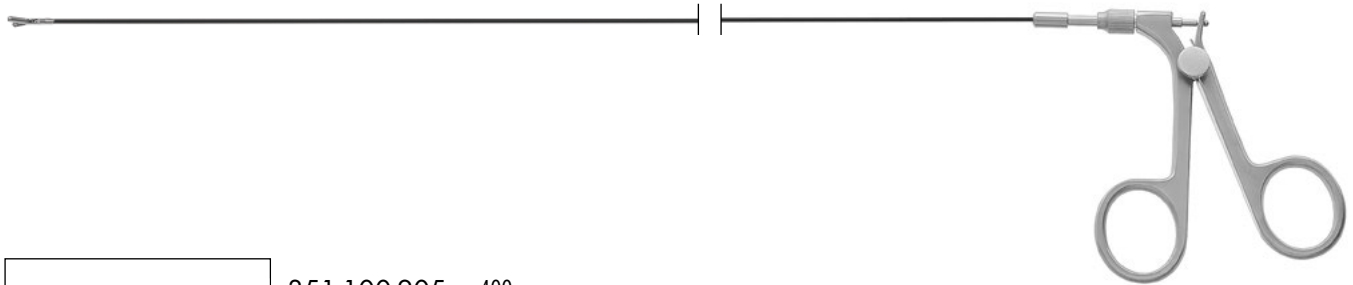

351-100-205 400mm
351-100-235 340mm
Scissors, blunt tips, single action



351-116-205 400mm
351-116-235 340mm
Grasping Forceps with cup, serrated,
double action



351-120-205 400mm
351-120-235 340mm
Biopsy Forceps, double action

5 Charr. and 7 Charr. semi-rigid Hysteroscopy instruments

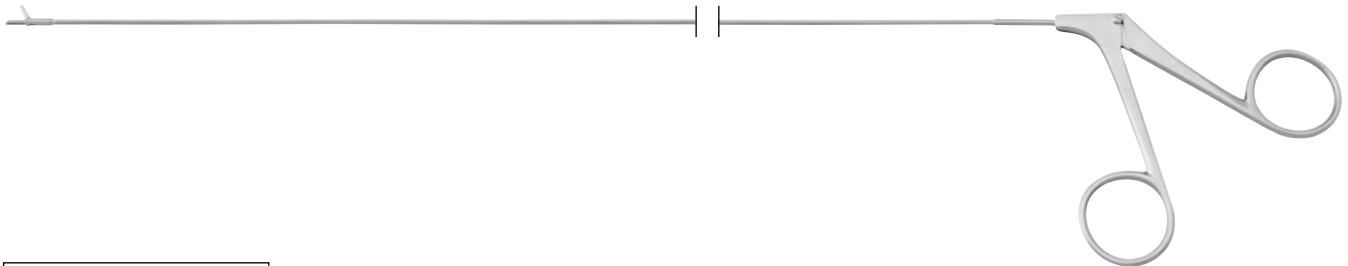

351-410-425 5 Charr.
351-410-427 7 Charr.
Scissors, blunt tips, single action,
400mm working length



351-410-325 5 Charr.
351-410-327 7 Charr.
Biopsy Forceps, oval cup, serrated,
400mm working length

5 Charr. Hexagonal Handle Hysteroscopy Instruments



351-125-105 400mm
351-125-135 340mm
Palpation Probe, graduated

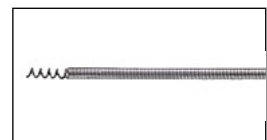

351-124-105 400mm
351-124-135 340mm
Myoma Fixation Screw, semi-rigid

5 Charr. Hysteroscopy Electrodes



351-360-005
Bipolar Needle Electrode, straight tip,
360mm working length



351-360-015
Bipolar Needle Electrode, 90° angled tip,
360mm working length



351-370-105
Bipolar Ball Electrode,
360mm working length

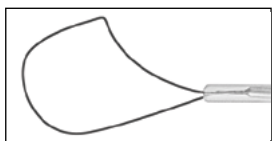

253-570-005
Polypectomy Snare,
340mm working length



351-380-360
Monopolar Needle Electrode,
360mm working length



351-385-360
Monopolar Ball Electrode,
360mm working length



BIPOLAR CABLES for Electrodes



Generator end



2-Banana *

Erbe

Valleylab
Lamidey, EMC

Martin, Aesculap
Berchtold

SDS plug

| | Flat plug | Flat plug, angled | Flat plug, square |
|----|-------------|-------------------|-------------------|
| 3m | 700-350-030 | 300-860-100 | 700-350-130 |
| 5m | 700-350-050 | 300-860-111 | 700-350-150 |
| 3m | 700-101-001 | 700-100-130 | 700-101-130 |
| 5m | 700-100-101 | 700-100-150 | 700-101-150 |
| 3m | 700-351-031 | 700-300-003 | 700-351-131 |
| 5m | 700-351-051 | 700-300-005 | 700-351-151 |
| 3m | 700-287-030 | 700-200-130 | 700-287-130 |
| 5m | 700-287-050 | 700-200-150 | 700-287-150 |
| 3m | 700-500-300 | | |
| 5m | 700-500-500 | | |

* Not available with CE marking within Europe

MONOPOLAR CABLES for Electrodes



| | | |
|--|-------------|--------------------------------------|
| | 253-610-001 | with 5 mm plug for Erbe HF-unit |
| | 253-610-002 | with 4 mm plug for Martin HF-unit |
| | 253-610-003 | with 8 mm plug for Valleylab HF-unit |
| | 253-610-004 | with 4 mm plug for older HF-units |
| | 700-501-453 | SDS Plug (Hysteroscopy coded) |

18.5 Charr. Grazia Hybrid Resectoscope - Set

The RZ Grazia HYBRID Resectoscope can be used in the common bipolar as well as in the monopolar way. The Surgeon just needs to change the cable, the rinsing fluid and connect the neutral electrode for monopolar usage. The Resectoscope as well as the Electrodes can be used in an hybrid way. The small 18.5Charr system comes up with numerous advantages like the optimal and painless use with virgo patients.

Even with this small and handy system the surgeon is able to treat all the hysteroscopic pathologies like polyps, myomas, uterus septa, isthmocele and endometrial ablation. Direct vaginoscopy access is possible and no cervical dilation is needed to proceed time-saving surgeries with 16 Charr. Electrodes and Cold Knife components.

351-900-911 18.5 CHARR. GRAZIA HYBRID RESECTION SET

HYBRID
HYBRID



| | |
|-------------|---|
| 351-829-030 | Hysteroscope, 30°, Ø 2.9mm, autoclavable |
| 351-400-201 | Grazia HYBRID Working Element, active |
| or | (please choose) |
| 351-400-200 | Grazia HYBRID Working Element, passive |
| 351-000-185 | Resectoscope Sheath, rotatable, ceramic tip |
| 351-000-201 | Loop Electrode |
| 351-000-203 | Knife Electrode |
| 351-000-205 | Ball Electrode |
| 351-000-180 | Visual Obturator, with 5 Charr. working channel |
| 253-300-999 | Sterilization tubes for electrodes |
| 600-485-555 | Stainless Steel Container, perforated, 480x254x55mm, with lid |
| 600-281-003 | Silicone mat, green, 440x230mm |
| 700-500-453 | SDS Cable, 4.5m, bipolar |
| 700-501-453 | SDS Cable, 4.5m, monopolar |
| 700-503-003 | Cable for Neutral Electrode |
| 700-503-000 | Disposable Neutral Electrode, pack of 50 pcs. |



Neutral Electrode with cable

Further suitable Instruments can be found on pages 20-23

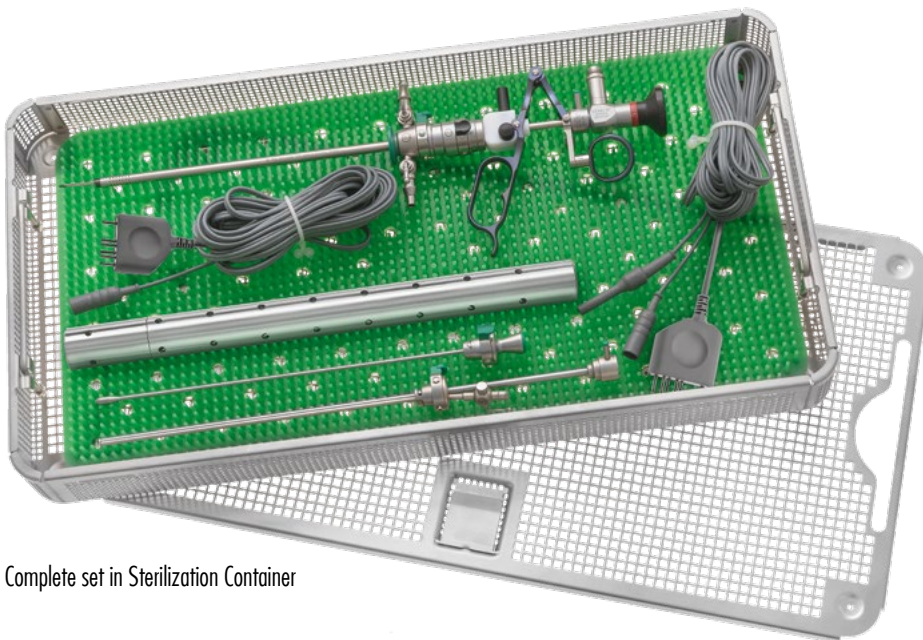
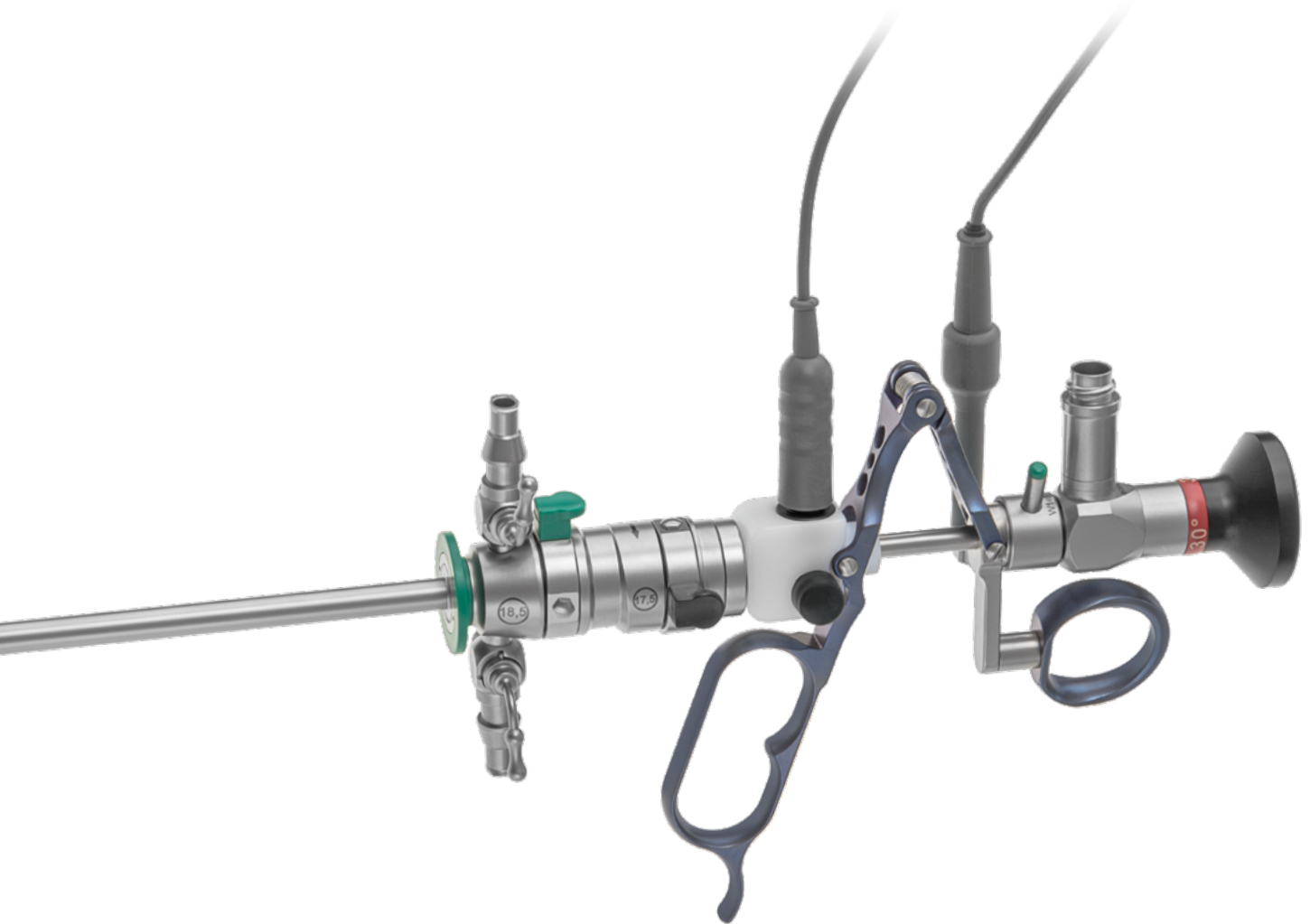

Complete set in Sterilization Container

Grazia HYBRID Resectoscope - 18.5 Charr.



HYBRID

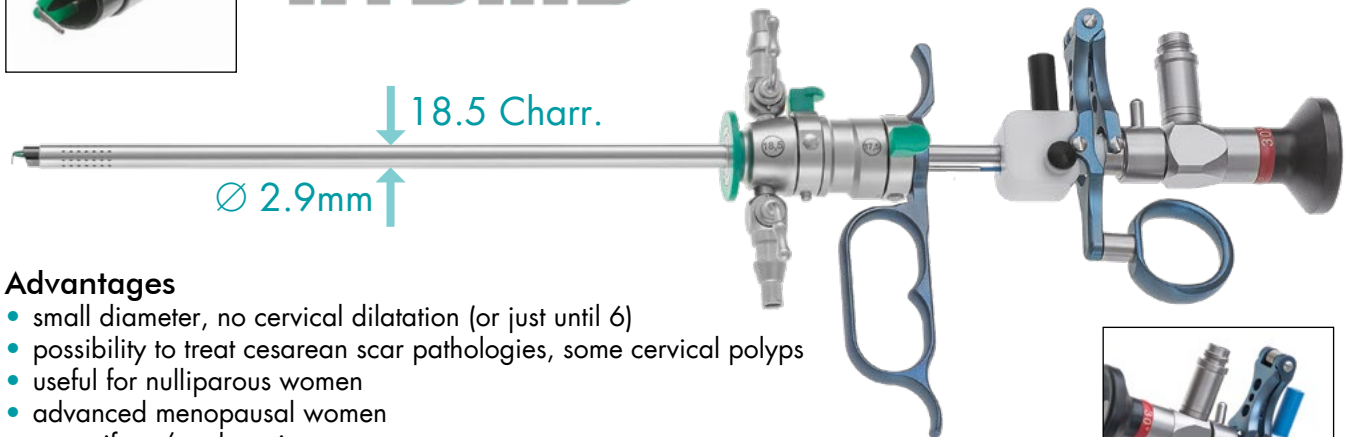

18.5 Charr.
 \varnothing 2.9mm

Advantages

- small diameter, no cervical dilatation (or just until 6)
- possibility to treat cesarean scar pathologies, some cervical polyps
- useful for nulliparous women
- advanced menopausal women
- tamoxifene/gn-rh patients
- cervical stenosis in general
- suspected endometrial and cervical cancer

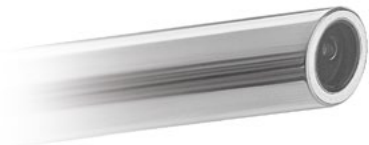
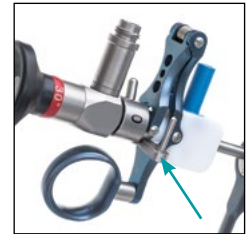

351-829-012
 Hysteroscope, \varnothing 2.9mm, 12° direction of view, 300mm working length, overall length: 355mm



351-829-030
 Hysteroscope, \varnothing 2.9mm, 30° direction of view, 300mm working length, overall length: 355mm



351-400-200
Passive Titanium Working Element for
Grazia HYBRID Resectoscope



351-400-201
Active Titanium Working Element for
Grazia HYBRID Resectoscope

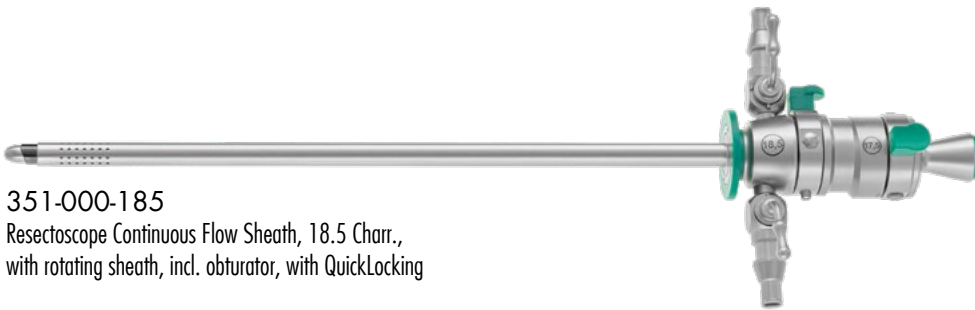

351-000-185
Resectoscope Continuous Flow Sheath, 18.5 Charr.,
with rotating sheath, incl. obturator, with QuickLocking



351-000-180
Visual Obturator, with 5 Charr. working channel

16 Charr. Electrodes Designed for RZ HF units shown on pages 80-83. Optimized and excellent for RZ Grazia HYBRID resection.



| | | |
|--|-------------|------------------------|
| | 351-000-201 | Cutting loop |
| | 351-000-202 | Cutting loop, straight |
| | 351-000-203 | Knife Electrode |
| | 351-000-205 | Ball Electrode |
| | 351-000-206 | Roller Electrode, 2mm |

26 Charr. HYBRID Resectoscope - Set

The RZ HYBRID Resectoscope can be used in the common bipolar as well as in the monopolar way. The Surgeon just needs to change the cable, the rinsing fluid and connect the neutral electrode for monopolar usage. The Resectoscope as well as the Electrodes can be used in an hybrid way. The small 18.5Charr system comes up with its numerous advantages like the optimal and painless use with virgo patients. This 26 Charr. Resectoscope with its classic instrumentation can be used for large-scale myomas, polyps and endometrial ablation.

351-900-912 26 CHARR. HYBRID RESECTION SET



| | |
|-------------|---|
| 351-804-030 | Hysteroscope, 30°, Ø 4mm, autoclavable |
| 253-000-401 | HYBRID Working Element, active |
| or | (please choose) |
| 253-000-400 | HYBRID Working Element, passive |
| 253-000-256 | Resectoscope Sheath, rotatable, ceramic tip |
| 253-400-201 | Cutting Electrode |
| 253-400-203 | Collins Coagulation Electrode |
| 253-400-205 | Ball Electrode |
| 253-000-094 | Visual Obturator, with 6 Charr. working channel |
| 253-300-999 | Sterilization tubes for electrodes |
| 600-485-555 | Stainless Steel Container, perforated, 480x254x55mm, with lid |
| 600-281-003 | Silicone mat, green, 440x230mm |
| 700-500-453 | SDS Cable, 4.5m, bipolar |
| 700-501-453 | SDS Cable, 4.5m, monopolar |
| 700-503-003 | Cable for Neutral Electrode |
| 700-503-000 | Disposable Neutral Electrode, pack of 50 pcs. |



Neutral Electrode with cable

Further suitable Instruments can be found on pages 26-29

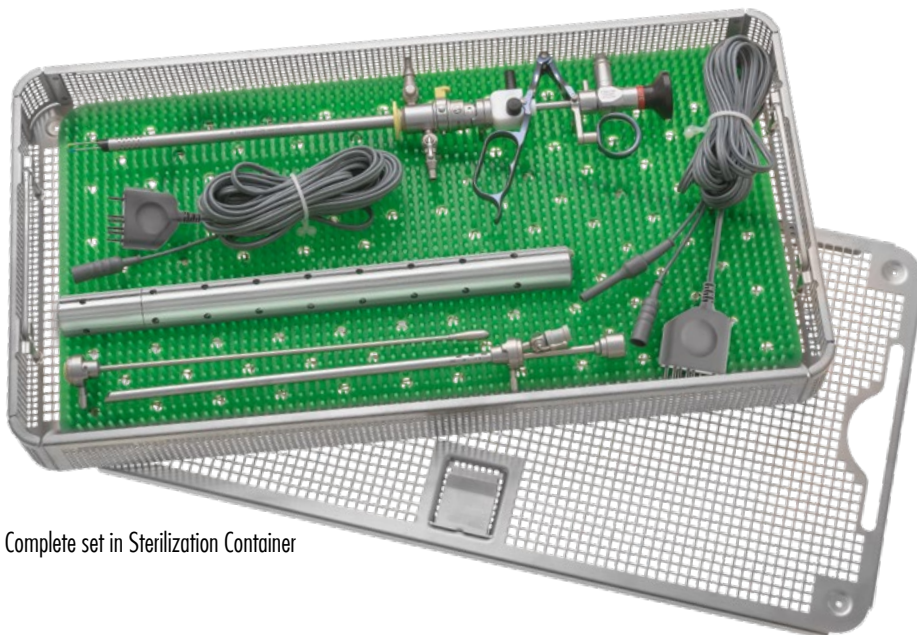
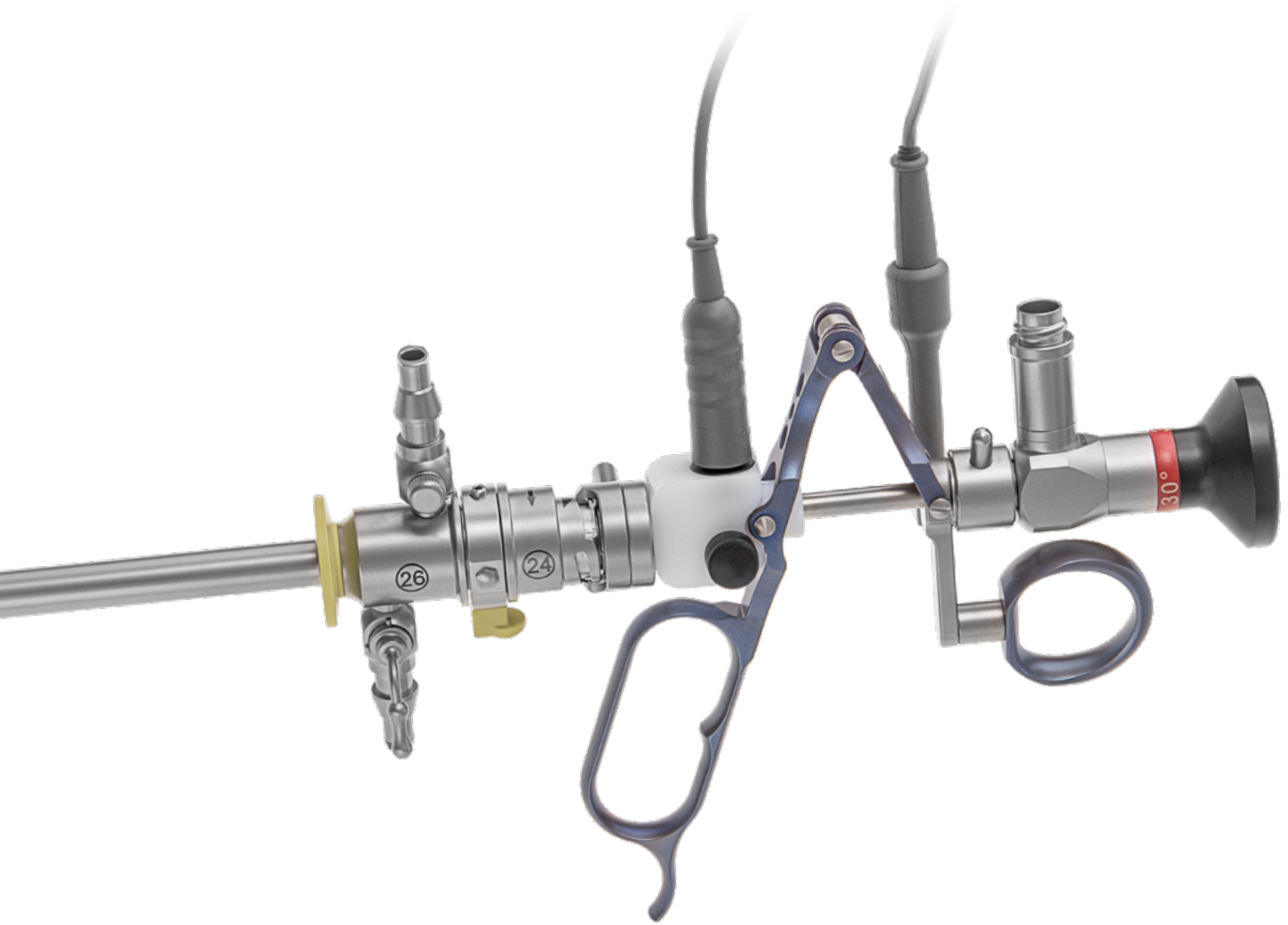

Complete set in Sterilization Container

Hybrid Resectoscope - 26 Charr.

HYBRID
HYBRID

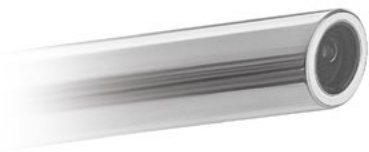
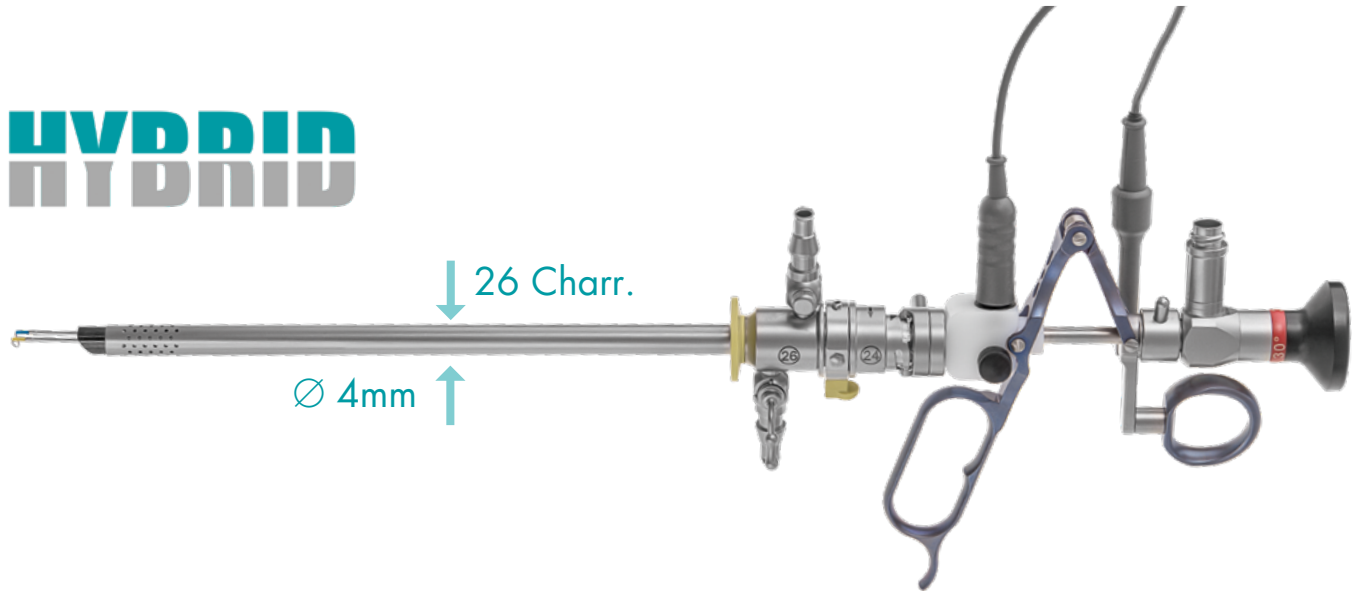

351-804-012
Hysteroscope, \varnothing 4mm, 12° direction of view, 300mm working length, overall length: 355mm



351-804-030
Hysteroscope, \varnothing 4mm, 30° direction of view, 300mm working length, overall length: 355mm

RZ HYBRID working elements features

- lightweight and unique design for maximum comfort during long surgeries
- titanium handle parts
- sealed locking mechanism
- ergonomic handle design with finger rest for maximum comfort even on long surgeries
- rotating titanium thumb ring

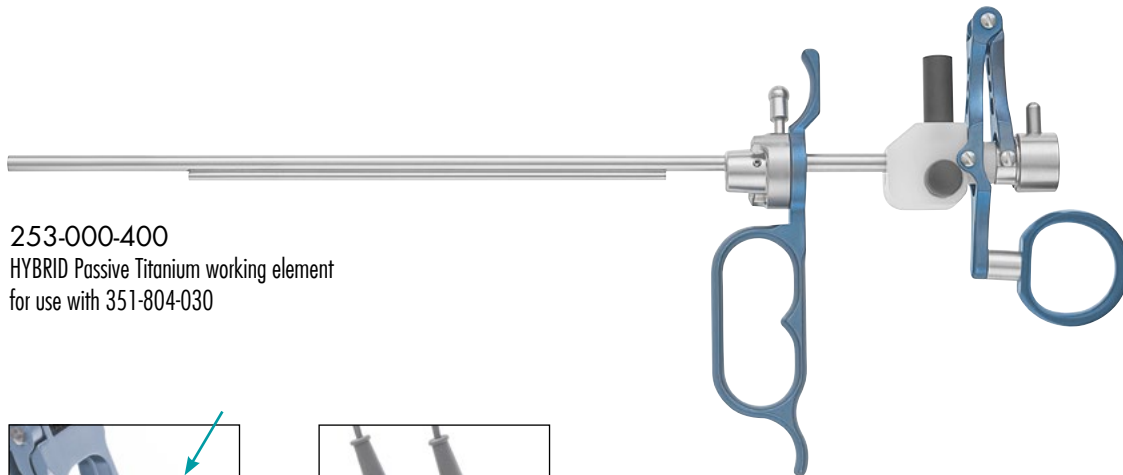

253-000-400
HYBRID Passive Titanium working element
for use with 351-804-030

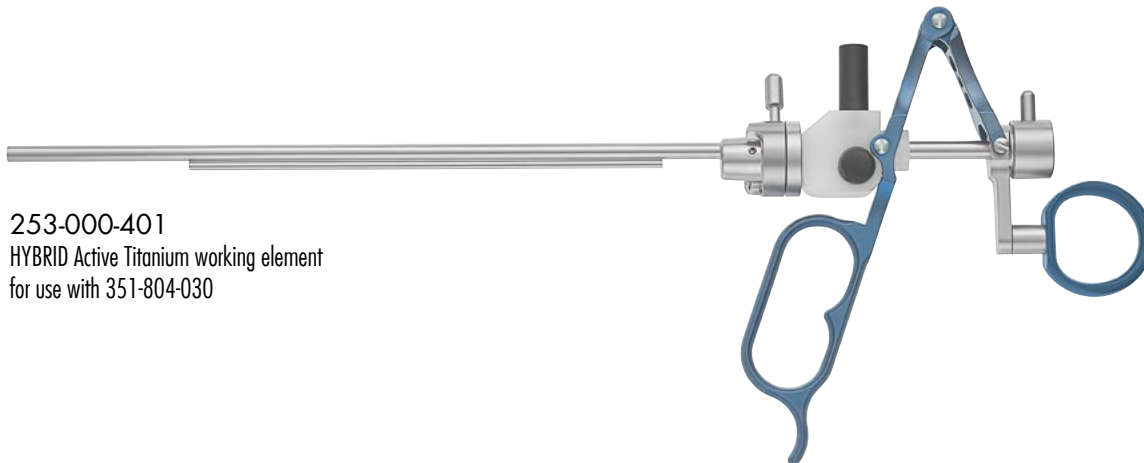
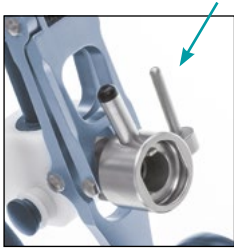

253-000-401
HYBRID Active Titanium working element
for use with 351-804-030

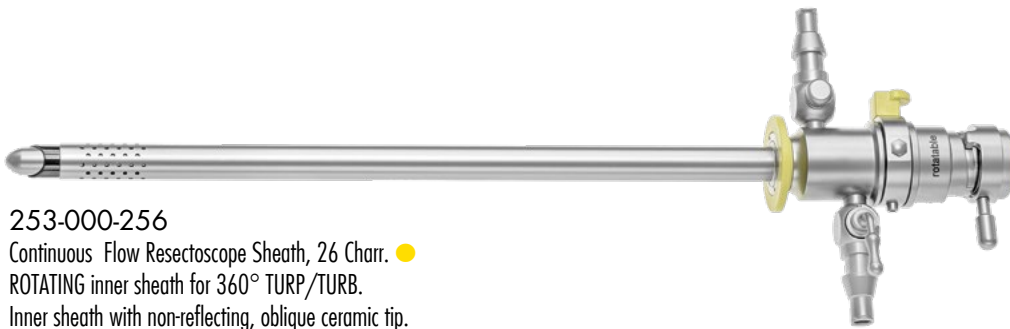

253-000-256
 Continuous Flow Resectoscope Sheath, 26 Charr. ●
 ROTATING inner sheath for 360° TURP/TURB.
 Inner sheath with non-reflecting, oblique ceramic tip.
 New RZ QuickLock mechanism for easy and fast assembling/disassembling.

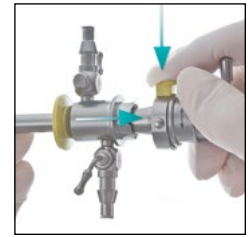

253-000-266
 Inner sheath with oblique ceramic tip for 253-000-256 ●

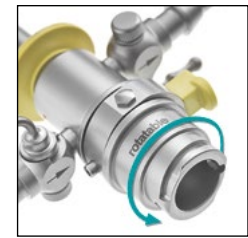

253-000-084
 Visual Obturator for 24/26 Charr. Resectoscope Sheaths
 and 4mm RZ Cystoscopes



253-000-094
 Visual Obturator with 5 Charr. working channel
 for 24/26 Charr. Resectoscope Sheaths and
 4mm RZ Cystoscopes



24 Charr. Electrodes

Designed for RZ HF units shown on pages 78-81. Optimized and fits excellent for RZ HYBRID resection.



253-400-200

Cutting loop, straight, for 12°/30° telescope



253-400-201

Cutting Loop, angled, for 12°/30° telescope



253-400-202

Cutting Loop, thick wire, angled, for 12°/30° telescope



253-400-203

Collins Coagulation Electrode, pointed



253-400-204

Coagulation Electrode, conical



253-400-205

Coagulation Electrode, ball shape, \varnothing 3mm



253-400-211

Roller-Electrode, \varnothing 3mm

Use the Accardi Cold Knives to perform „one step hysteroscopic myomectomies“ on all intramural-submucous myomas.

Advantages:







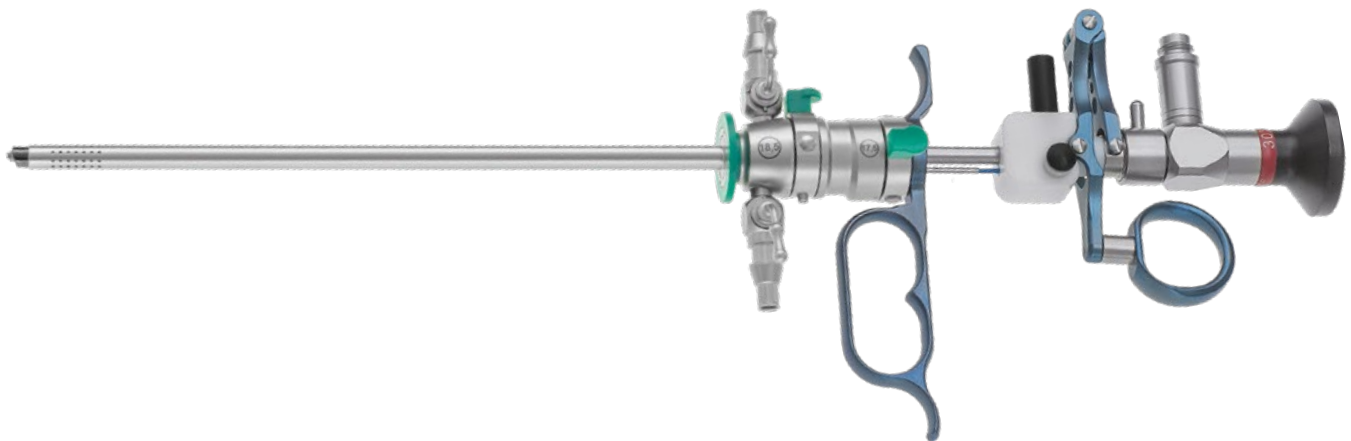

- Easy to use
- „one step“ procedure
- useful for all myomas G0 - G1 - G2
- safe procedure for the patient
- no electricity - no myometrial scar and damage
- no electricity - no perforation of the uterus
- available for 18.5 Charr. as well as 26 Charr. Resectoscope Systems



Accardi Cold Knives for use with the Grazia HYBRID Resectoscope - 18.5 Charr.



16 Charr.

| | | | |
|---|---|-------------|----------------|
|  |  | 351-400-410 | Accardi Cometa |
|  |  | 351-400-415 | Accardi Orbit |
|  |  | 351-400-420 | Accardi Hook |
|  |  | 351-400-430 | Accardi L-Hook |



Accardi Cold Knives for use with the
RZ Hybrid Resectoscope - 26 Charr.

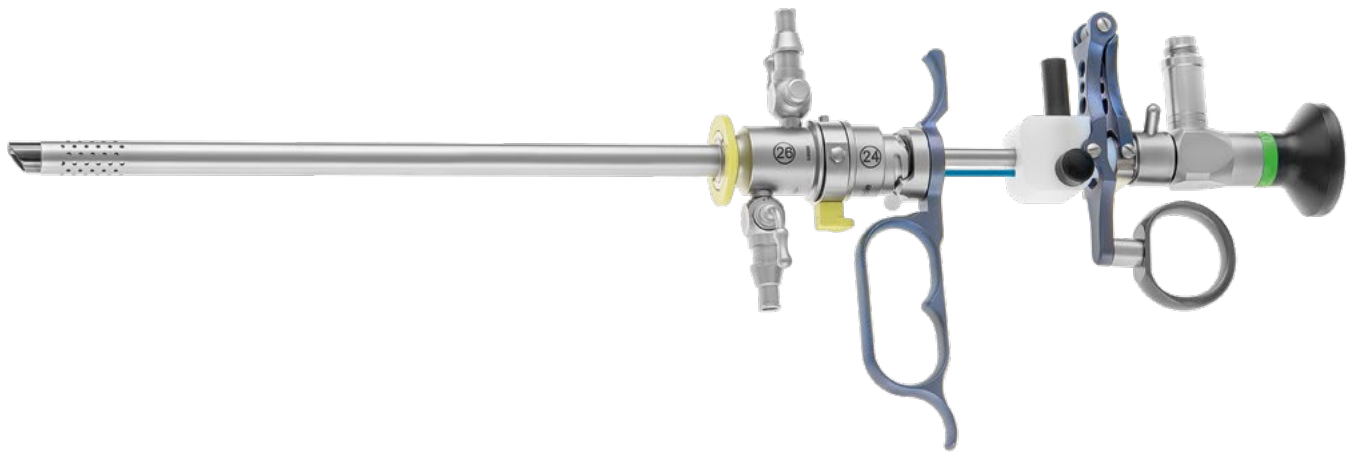

24 Charr.



351-000-410

Accardi Loop



351-000-415

Accardi Rake



351-000-420

Accardi Knife

 Italian Design  Made in Germany

DR. ACCARDI
INSTRUMENTS

Bipolar Working Elements for GYNECARE-VERSAPOINT Bipolar Electrodes

RZ compatible



351-000-400
Passive Titanium Working Element for use with
 RZ Resectoscope Sheaths 253-000-256/253-000-356
 and 4mm, 12°/30° RZ Hysteroscopes
 351-804-012/351-804-030

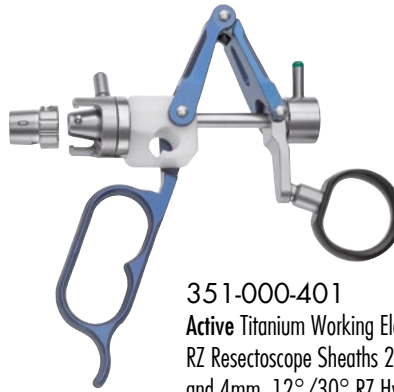

351-000-401
Active Titanium Working Element for use with
 RZ Resectoscope Sheaths 253-000-256/253-000-356
 and 4mm, 12°/30° RZ Hysteroscopes
 351-804-012/351-804-030

OLYMPUS compatible



351-000-500
Passive Titanium Working Element for use with
 OLYMPUS Resectoscope Sheaths and Telescopes



351-000-501
Active Titanium Working Element for use with
 OLYMPUS Resectoscope Sheaths and Telescopes

RICHARD WOLF  compatible



351-000-600
Passive Titanium Working Element for use with
 R. WOLF Resectoscope Sheaths and Telescopes



351-000-601
Active Titanium Working Element for use with
 R. WOLF Resectoscope Sheaths and Telescopes

Bipolar Cables for Resectoscopes

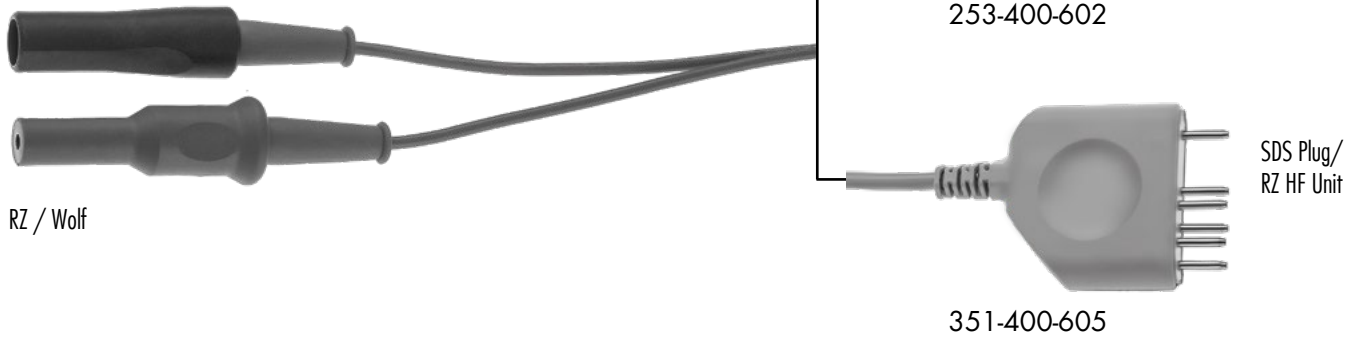

Monopolar Cables for Resectoscopes

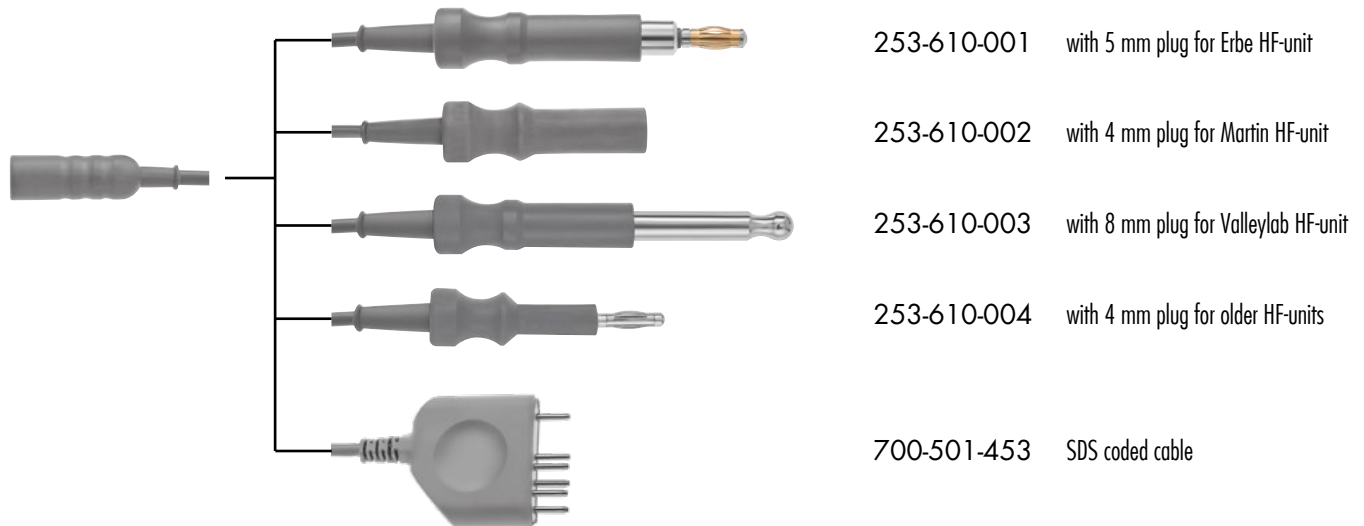

The complete instrument consists of a autoclavable handle with a connection for monopolar use and the loop which can be ordered also as a spare part. The instrument can be used with a normal 5.5 mm trocar.

The main advantage of the laparoscopic supracervical hysterectomy is the salvage of the cervix. Due to a lot of torns at the cervix, there will be no vaginal descensus.

Additionally the intervention proceeds more rapidly, more gently and with fewer complications. Among other things, there is no open abdominal section, which contributes to faster recovery of the patient.

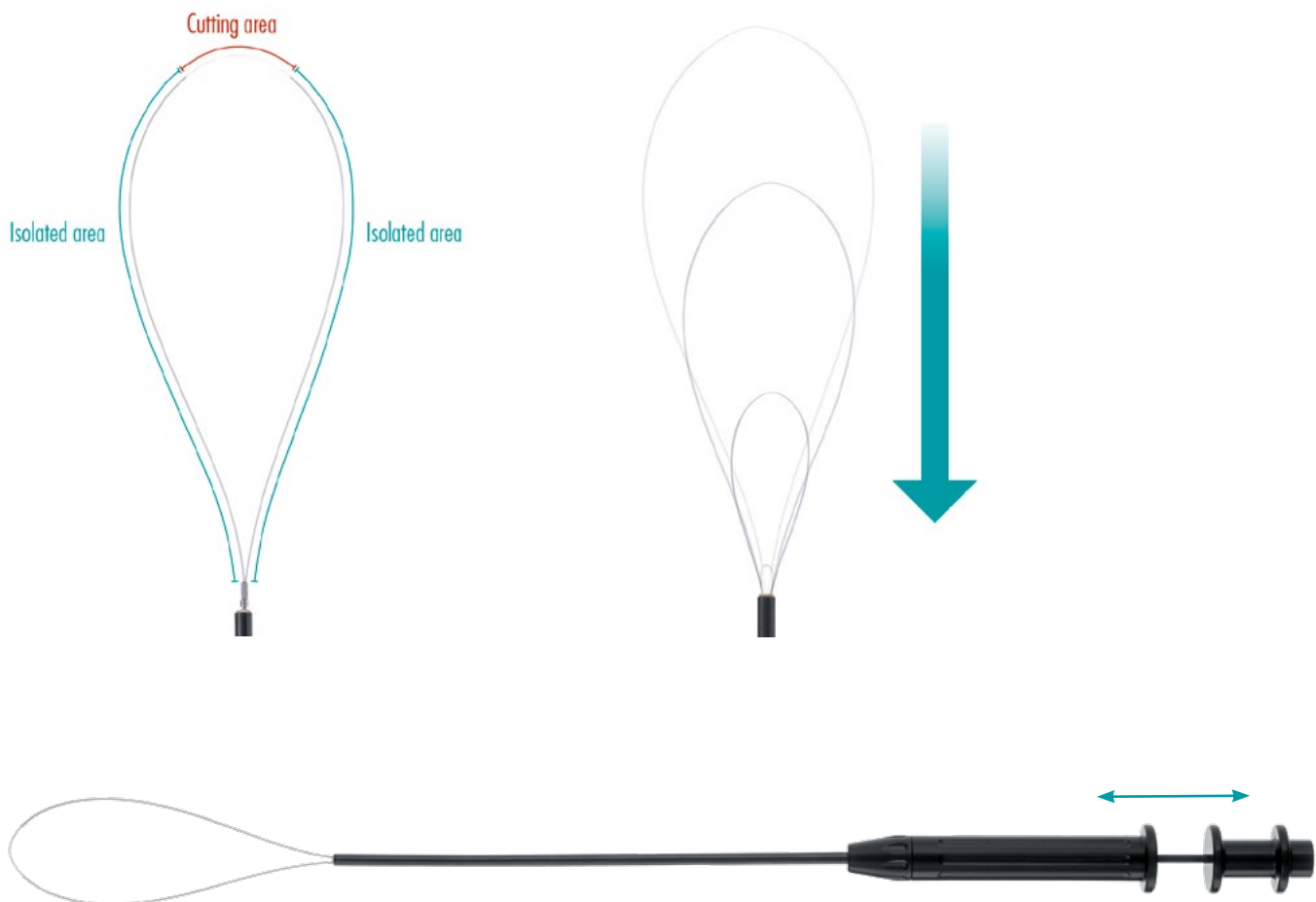

350-754-000
Hysterectomy Instrument with \varnothing 100mm wire loop electrode

- SPARE WIRE LOOPS (single use, non-sterile)
- 350-754-001 \varnothing 100mm
 - 350-754-002 \varnothing 125mm
 - 350-754-003 \varnothing 65mm

The needles of these monopolar electrodes are extremely delicate to ensure precise and exact cutting.

RZ offers two different types – a micro needle electrode with cutting function and a combined micro needle electrode with cutting and coagulation function. This combi instrument enables precise cutting with pulled out needle and stopping bleedings with retracted needle. Both of them can be retracted for safe handling during the surgery.

MICRO NEEDLE ELECTRODE



Pulled out needle
cutting function

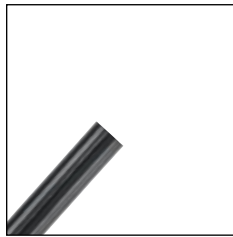

Retracted needle
Safe handling



350-752-320 320mm
350-752-420 420mm
Micro Needle Electrode for monopolar cutting

SPARE MICRO NEEDLE (Quantity: 12)
350-752-001

COMBINED MICRO NEEDLE ELECTRODE



Pulled out needle
Cutting & coagulation



Retracted needle
Only coagulation



350-753-320 320mm
350-753-420 420mm
Combined Micro Needle Electrode for cutting and coagulation

SPARE MICRO NEEDLE (Quantity: 12)
350-753-001

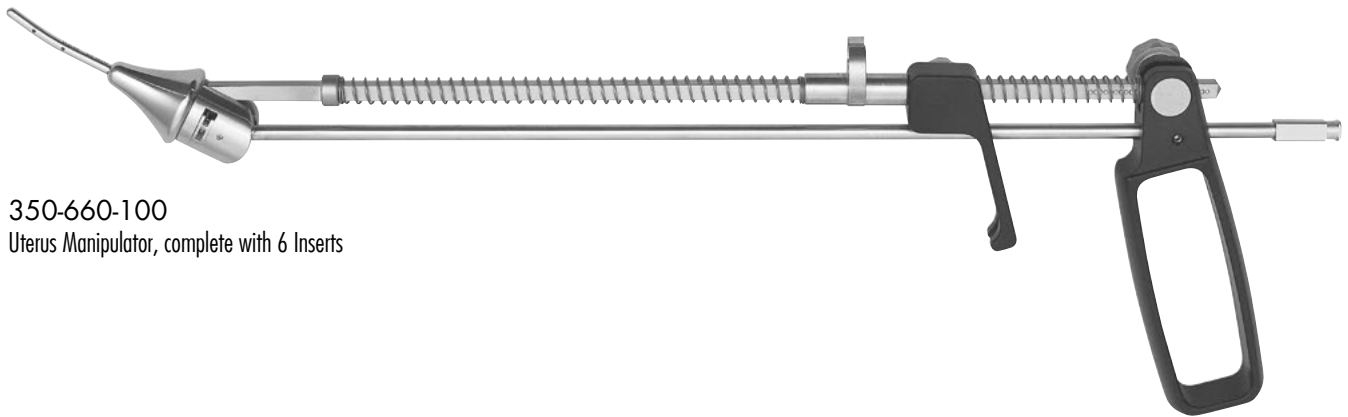

350-660-100
Uterus Manipulator, complete with 6 Inserts

Inserts



350-660-111
Ø 8 x 80mm



350-660-112
Ø 10 x 100mm



350-660-113
Ø 3 x 45mm



350-660-114
Ø 3 x 55mm



350-660-115
Ø 3.2 x 34mm



350-660-116
Ø 3.2 x 45mm



1
 350-740-000
Mangeshikar
 Uterus Manipulator, complete set

2
 350-740-005 35mm
 350-740-006 40mm
 350-740-007 45mm
 Tube with insulation ring

3
 350-740-040 4x40mm
 350-740-050 5x50mm
 350-740-060 6x60mm
 350-740-070 7x70mm
 350-740-080 8x80mm
 Intrauterus tip insert

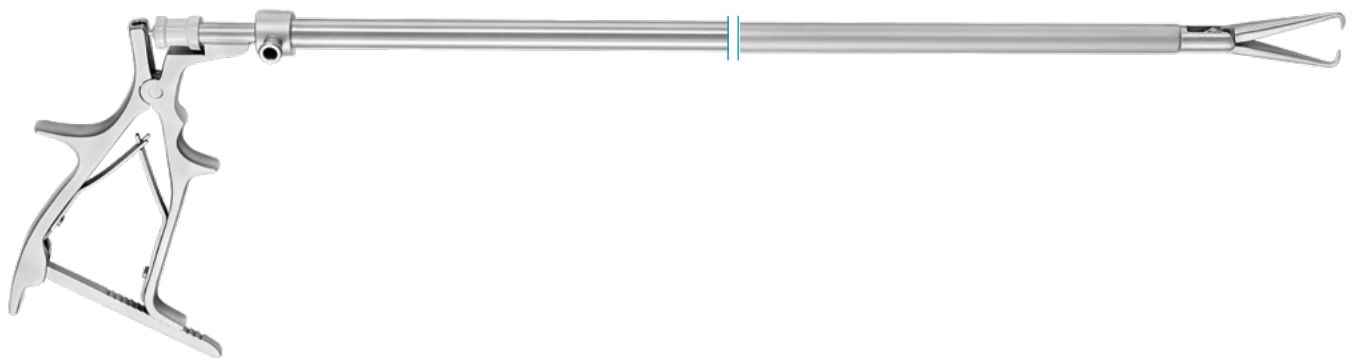

Strong Grasping Forceps for use through a Morcellator blade or trocar sleeve during endoscopic morcellation procedures. All instruments feature a strong flip-away ratchet, Luer-Lock cleaning channel and have a working length of 420mm.



300-110-714
 Tenaculum Forceps, Ø10mm



300-110-711
 Claw Forceps, Ø10mm



300-110-715
 Tenaculum Forceps, Ø5mm



300-110-712
 Claw Forceps, Ø5mm



350-158-003
IUd Grasping Forceps 1 x 2 Teeth, flexible, Ø 3mm, with spring handle



Myoma screw
 300-032-015 Ø 5mm, 330 mm working length
 300-042-005 Ø 5mm, 420 mm working length
 300-033-010 Ø 10mm, 330 mm working length
 300-042-010 Ø 10mm, 420 mm working length

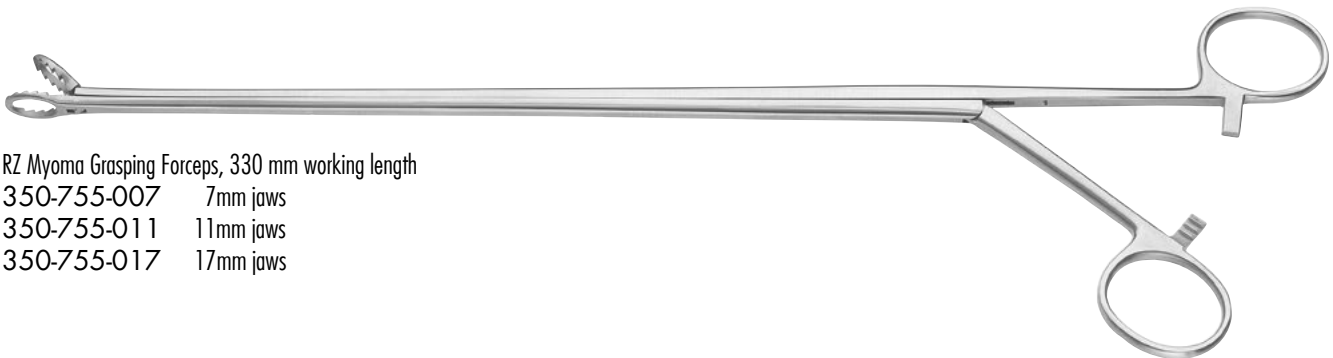

RZ Myoma Grasping Forceps, 330 mm working length
 350-755-007 7mm jaws
 350-755-011 11mm jaws
 350-755-017 17mm jaws

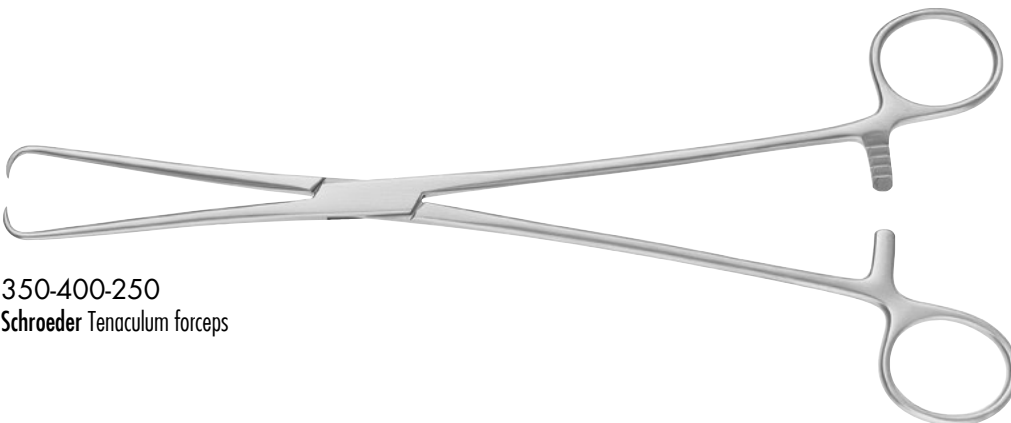

350-400-250
Schroeder Tenaculum forceps



351-815-160
Power light handle 3,6V, Xenon
incl. Storz-Adapter



Amnioscope Tubes, conical, with obturator, 200mm working length
351-815-012 12/24mm
351-815-016 16/24mm
351-815-020 20/24mm

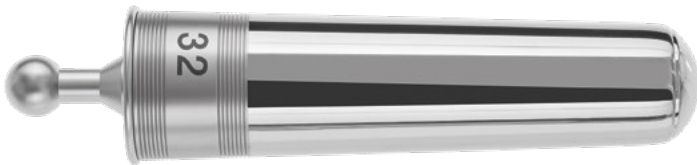

Amnioscope Tubes, conical, with obturator
351-815-118 18/40mm, 200mm working length
351-815-132 32/40mm, 140mm working length





300-011-181
LuerLock tube
connector 9mm



300-011-506
LuerLock tube
connector 6mm



300-011-184
LuerLock Tuohy
Borst Adapter

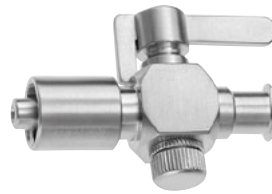

300-011-178
LuerLock one-way stop-cock
with spring screw cap



300-011-179
LuerLock tube connector with stopcock



300-400-900
Rubber Seals for LuerLock connectors

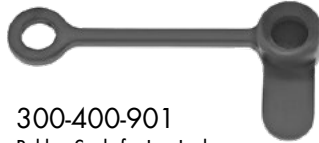

300-400-901
Rubber Seals for LuerLock
connectors



301-701-100
Grey Rubber cap for use
on all working channels



351-905-105
Disposable Silicone Valve with
LuerLock connection for use
with 3 - 10 Charr. instruments
sterile packed,
package with 10 pieces



Dittel Bougies, straight

| | | | |
|-------------|-----------|-------------|-----------|
| 253-320-225 | 8 Charr. | 253-329-225 | 22 Charr. |
| 253-321-225 | 9 Charr. | 253-330-225 | 24 Charr. |
| 253-322-225 | 10 Charr. | 253-331-225 | 25 Charr. |
| 253-323-225 | 11 Charr. | 253-332-225 | 26 Charr. |
| 253-324-225 | 12 Charr. | 253-333-225 | 27 Charr. |
| 253-325-225 | 14 Charr. | 253-334-225 | 28 Charr. |
| 253-326-225 | 16 Charr. | 253-335-225 | 30 Charr. |
| 253-327-225 | 18 Charr. | 253-336-225 | 32 Charr. |
| 253-328-225 | 20 Charr. | 253-337-225 | 34 Charr. |



Catheter for female

| | |
|-------------|-----------|
| 320-721-080 | 8 Charr. |
| 320-721-100 | 10 Charr. |
| 320-721-120 | 12 Charr. |
| 320-721-140 | 14 Charr. |
| 320-721-160 | 16 Charr. |
| 320-721-180 | 18 Charr. |
| 320-721-200 | 20 Charr. |
| 320-721-220 | 22 Charr. |
| 320-721-240 | 24 Charr. |

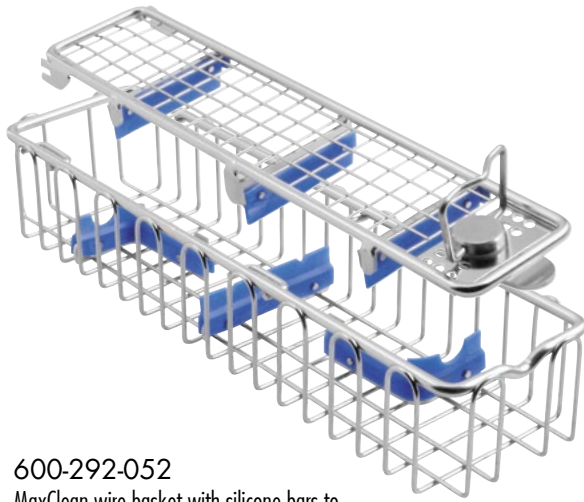

600-292-052

MaxClean wire basket with silicone bars to hold 2 short endoscopes with overall length of 230mm.
Dimensions: 290mm x 80mm x 55mm

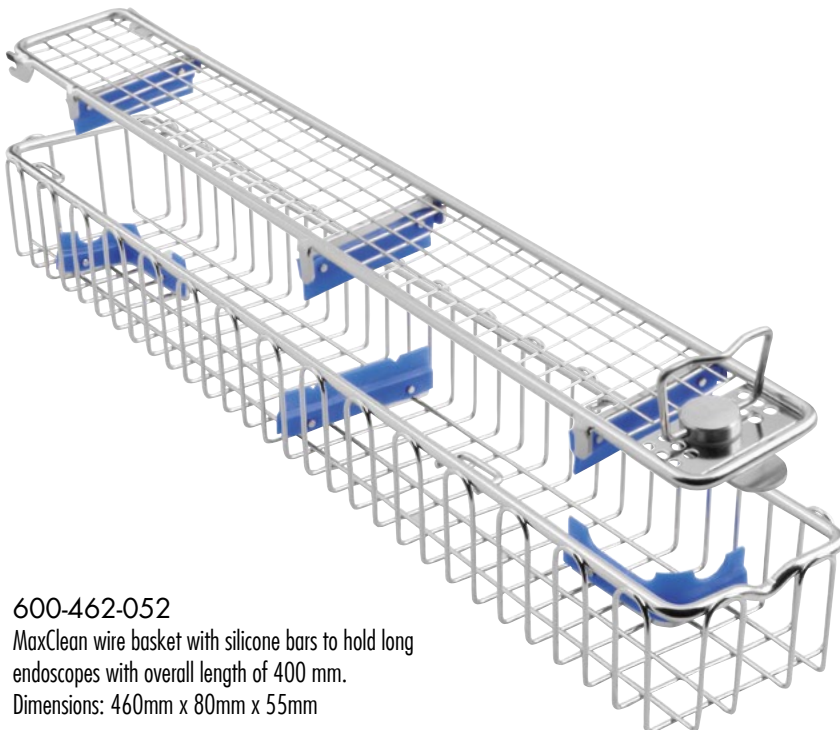

600-462-052

MaxClean wire basket with silicone bars to hold long endoscopes with overall length of 400 mm.
Dimensions: 460mm x 80mm x 55mm

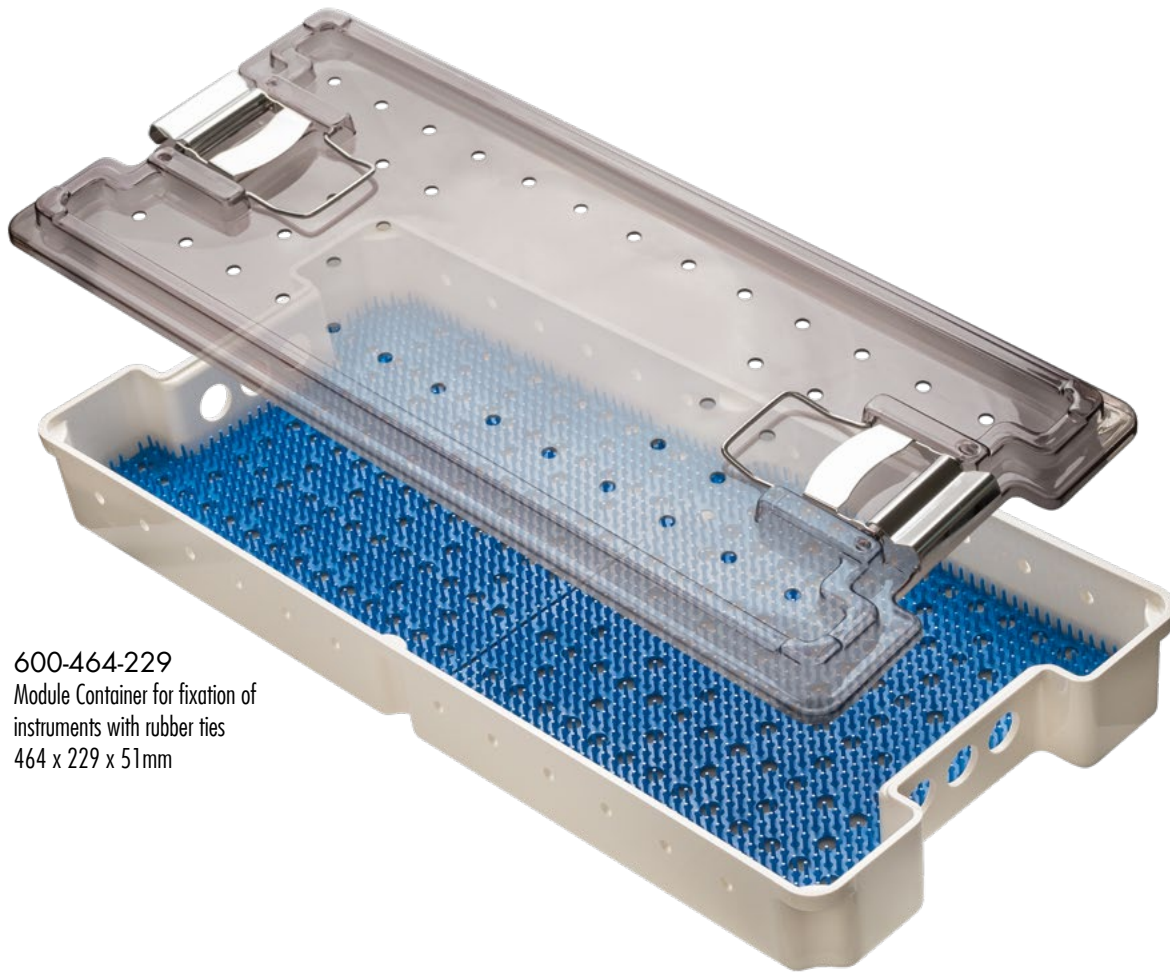

600-464-229
Module Container for fixation of
instruments with rubber ties
464 x 229 x 51mm

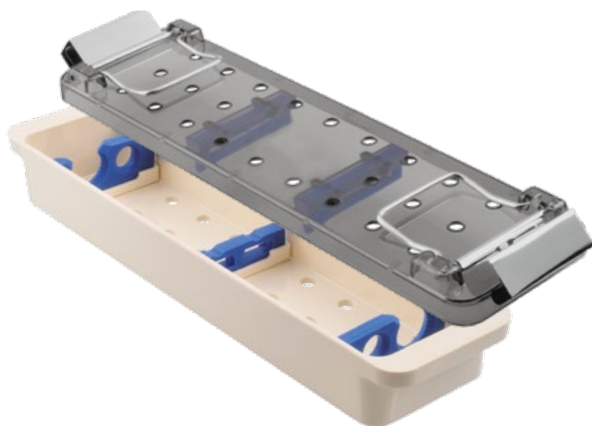

600-505-002 Safe+Clean double scope sterilization container to hold
2 short scopes with maximum length of 190 mm.
Dimensions: 271 x 70 x 35mm

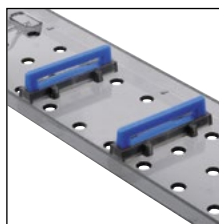

Safe and clean
with silicone bars on
base and lid

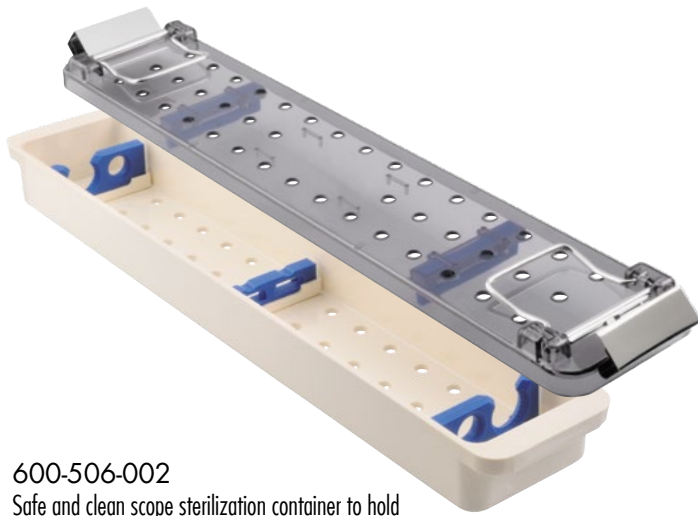

600-506-002

Safe and clean scope sterilization container to hold
2 medium scopes with maximum length of 390mm.
Dimensions: 394 x 70 x 35mm

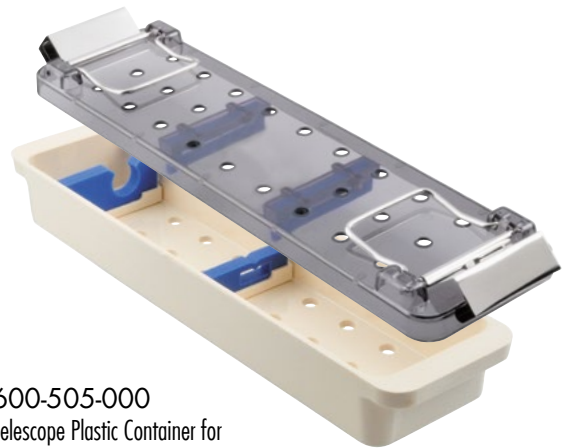

600-505-000

Telescope Plastic Container for
1 Telescope \varnothing 1-10mm max. length 270mm
271 x 70 x 35mm

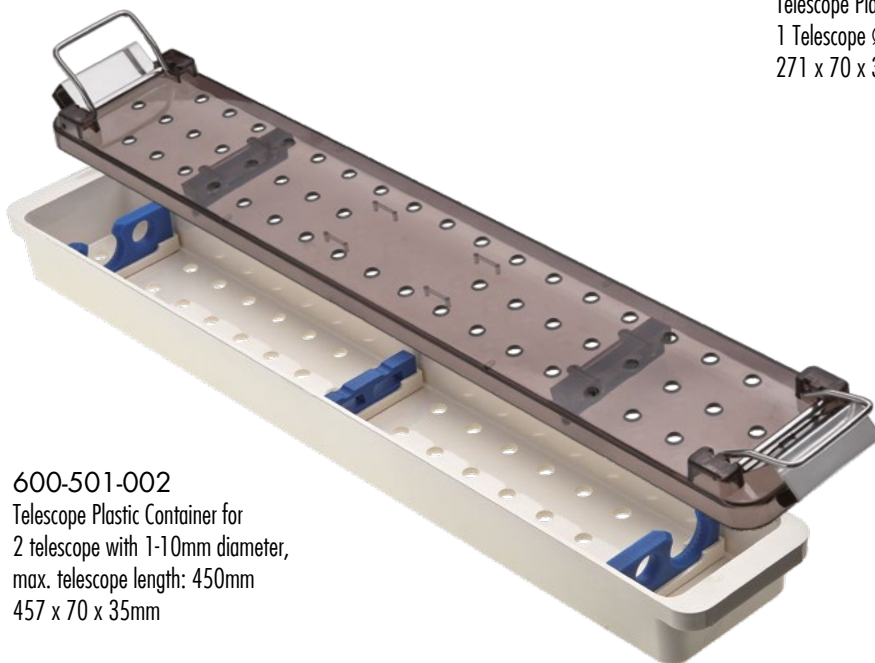

600-501-002

Telescope Plastic Container for
2 telescope with 1-10mm diameter,
max. telescope length: 450mm
457 x 70 x 35mm

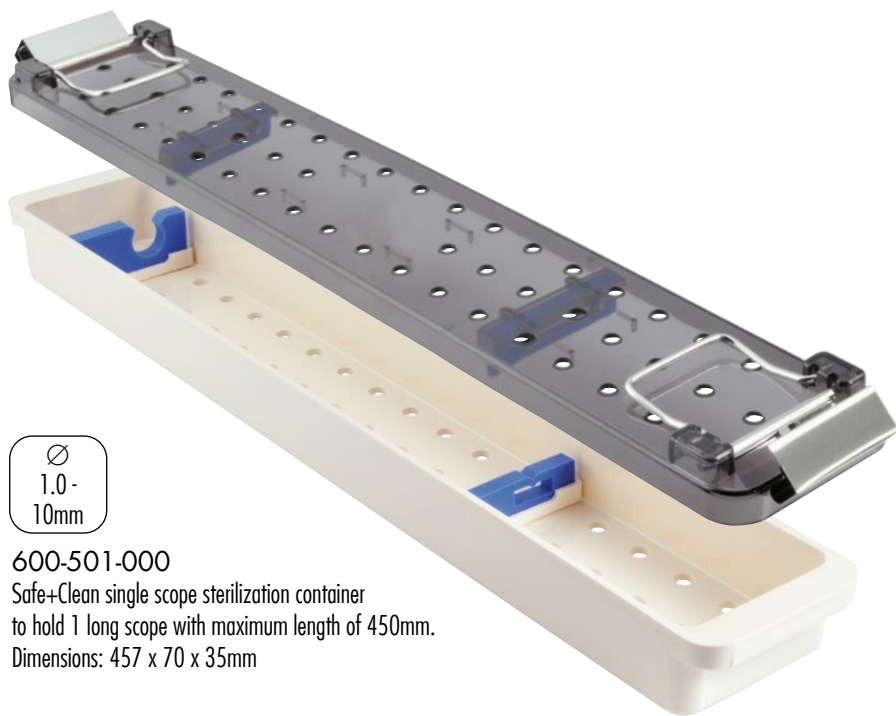

∅
1.0 -
10mm

600-501-000

Safe+Clean single scope sterilization container
to hold 1 long scope with maximum length of 450mm.
Dimensions: 457 x 70 x 35mm

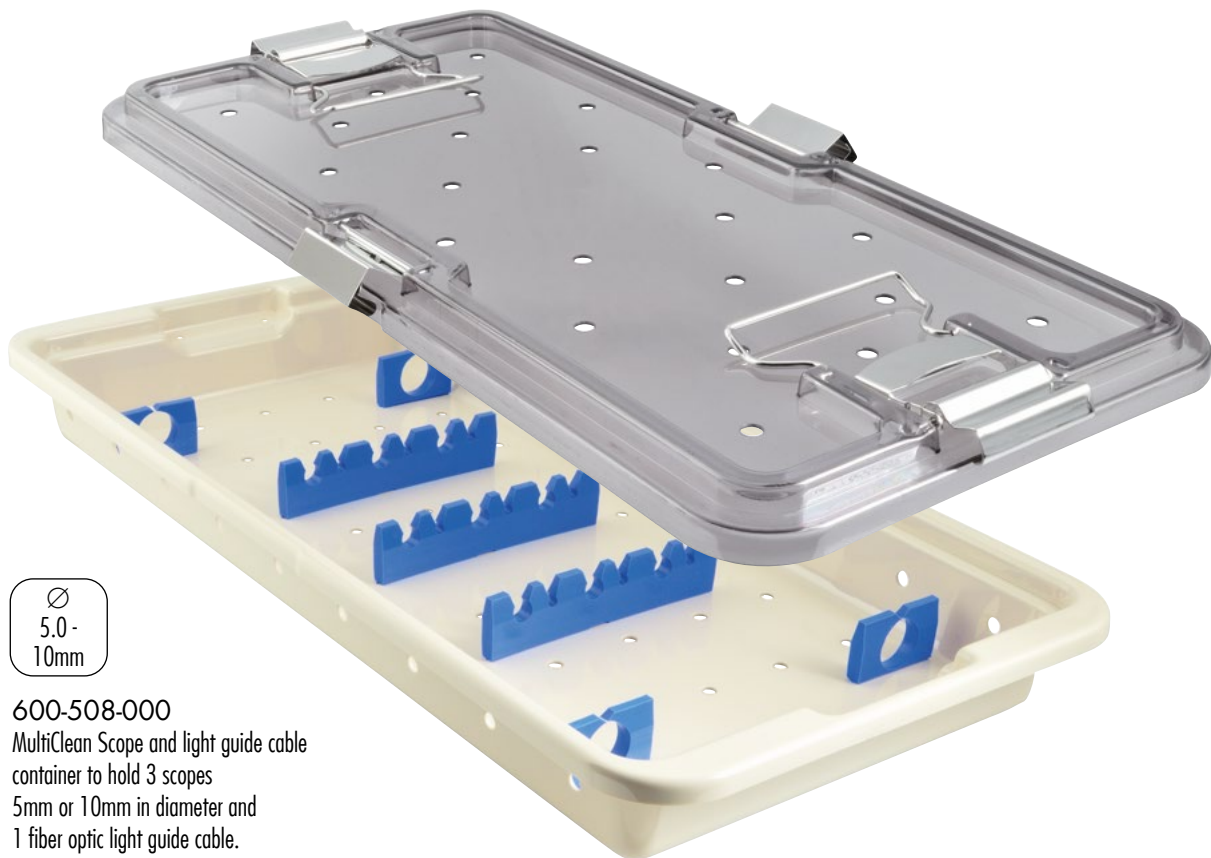

∅
5.0 -
10mm

600-508-000
MultiClean Scope and light guide cable
container to hold 3 scopes
5mm or 10mm in diameter and
1 fiber optic light guide cable.
Dimensions: 465 x 212 x 51mm

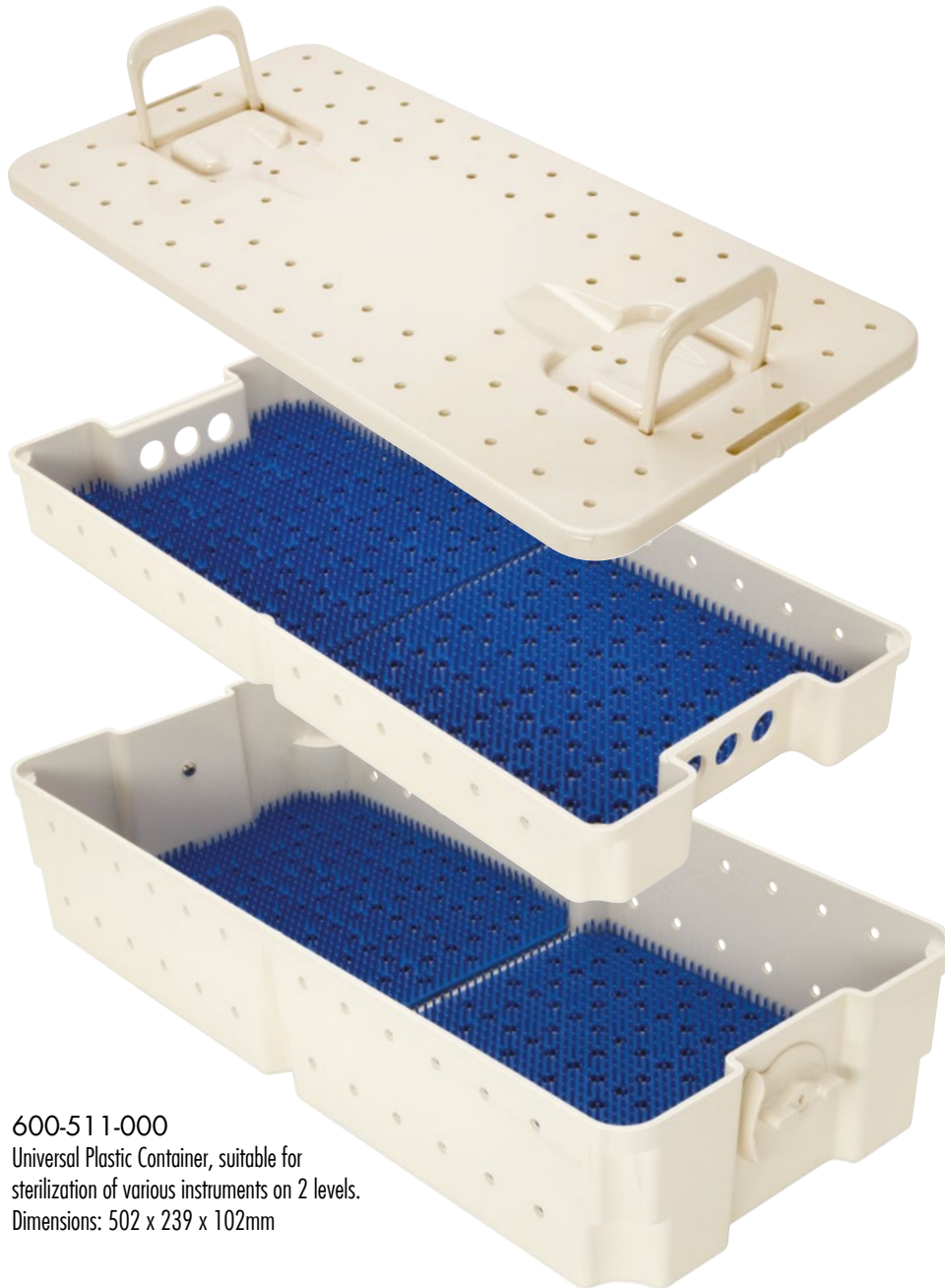

600-511-000
Universal Plastic Container, suitable for
sterilization of various instruments on 2 levels.
Dimensions: 502 x 239 x 102mm

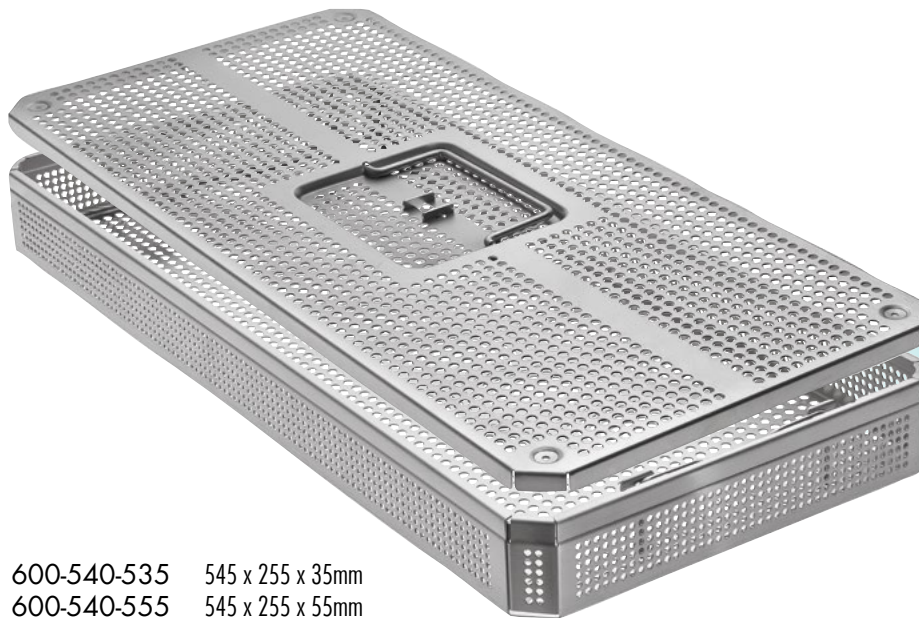

Stainless Steel Basket with
round perforation, with lid

545mm length

- 600-540-535 545 x 255 x 35mm
- 600-540-555 545 x 255 x 55mm
- 600-540-575 545 x 255 x 75mm
- 600-540-605 545 x 255 x 105mm



- Lid only
- 600-540-500 545 x 255mm



- Bottom only
- 600-540-530 545 x 255 x 30mm
- 600-540-550 545 x 255 x 50mm
- 600-540-570 545 x 255 x 70mm
- 600-540-600 545 x 255 x 100mm

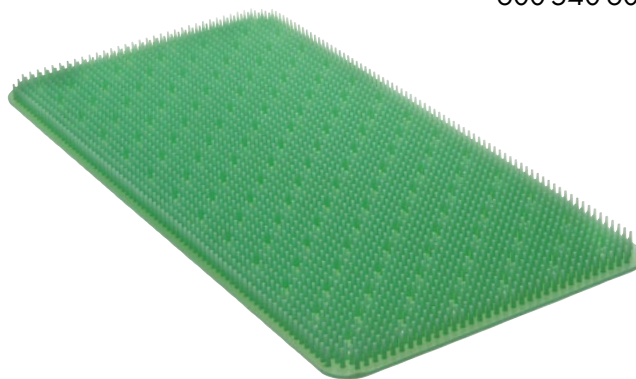

600-281-004
Silicone Mat, green, 500x230mm

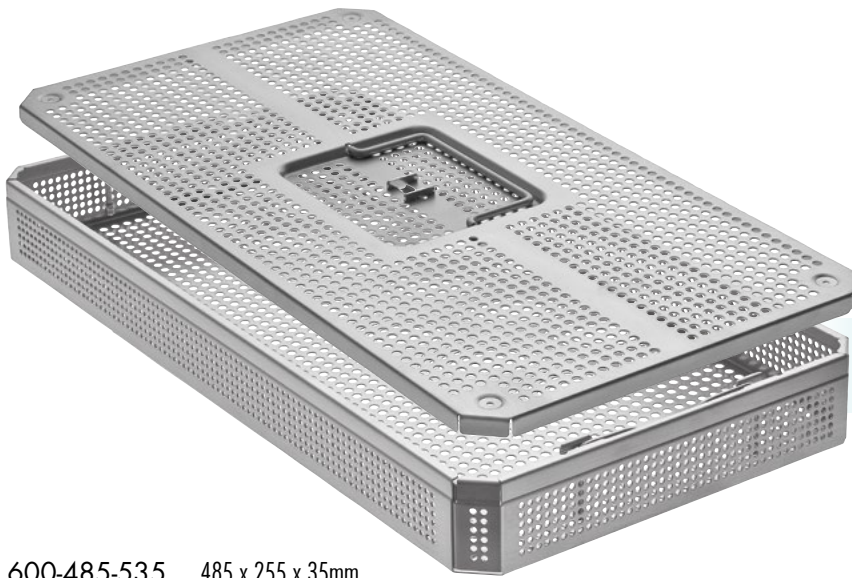

Stainless Steel Basket with round perforation, with lid

485mm length

- 600-485-535 485 x 255 x 35mm
- 600-485-555 485 x 255 x 55mm
- 600-485-575 485 x 255 x 75mm
- 600-485-605 485 x 255 x 105mm



- Lid only
- 600-485-500 485 x 255mm

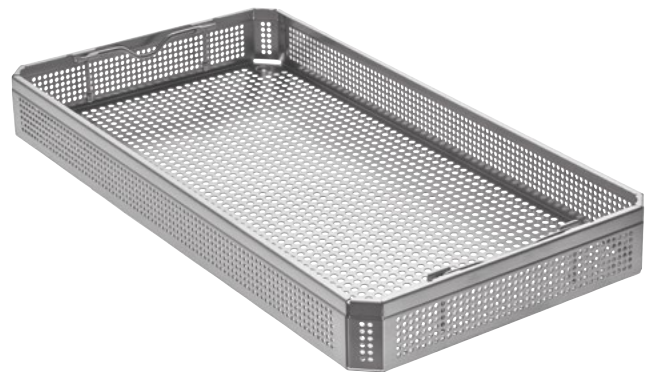

- Bottom only
- 600-485-530 485 x 255 x 30mm
- 600-485-550 485 x 255 x 50mm
- 600-485-570 485 x 255 x 70mm
- 600-485-600 485 x 255 x 100mm



- 600-281-003 Silicone Mat green, 440 x 230mm

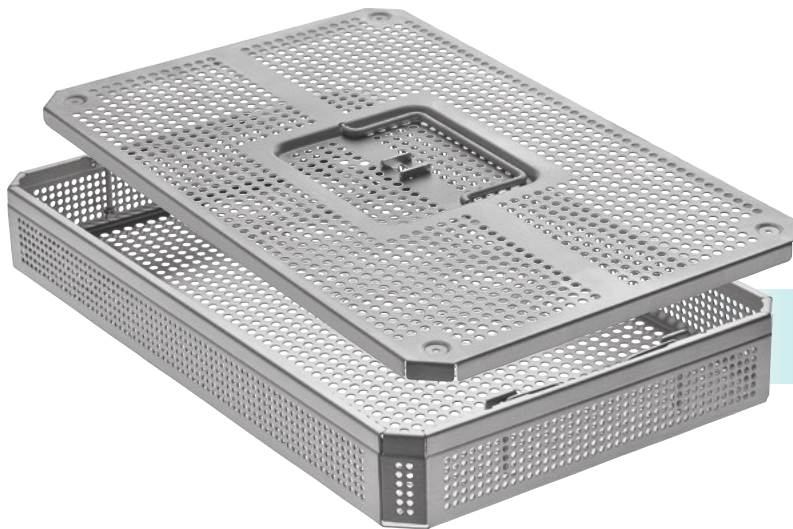

Stainless Steel Basket with round perforation, with lid

3/4
405mm length

- 600-405-535 405 x 255 x 35mm
- 600-405-555 405 x 255 x 55mm
- 600-405-575 405 x 255 x 75mm
- 600-405-605 405 x 255 x 105mm

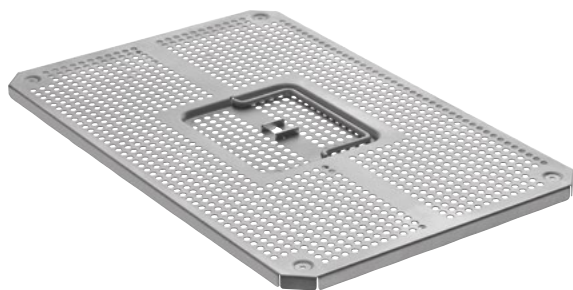

- Lid only
600-405-500 405 x 255mm

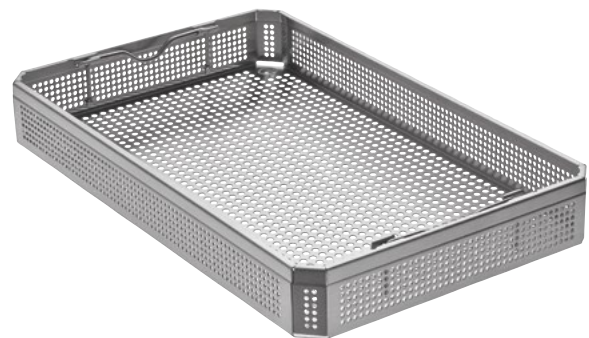

- Bottom only
- 600-405-530 405 x 255 x 30mm
 - 600-405-550 405 x 255 x 50mm
 - 600-405-570 405 x 255 x 70mm
 - 600-405-600 405 x 255 x 100mm

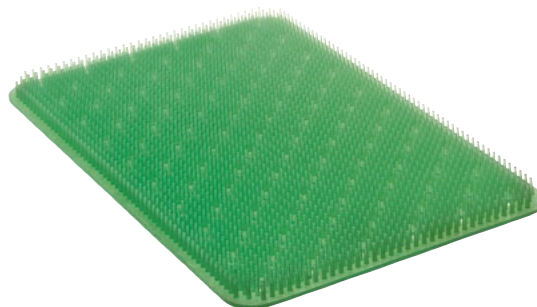

600-281-002 Silicone Mat green, 380 x 230mm

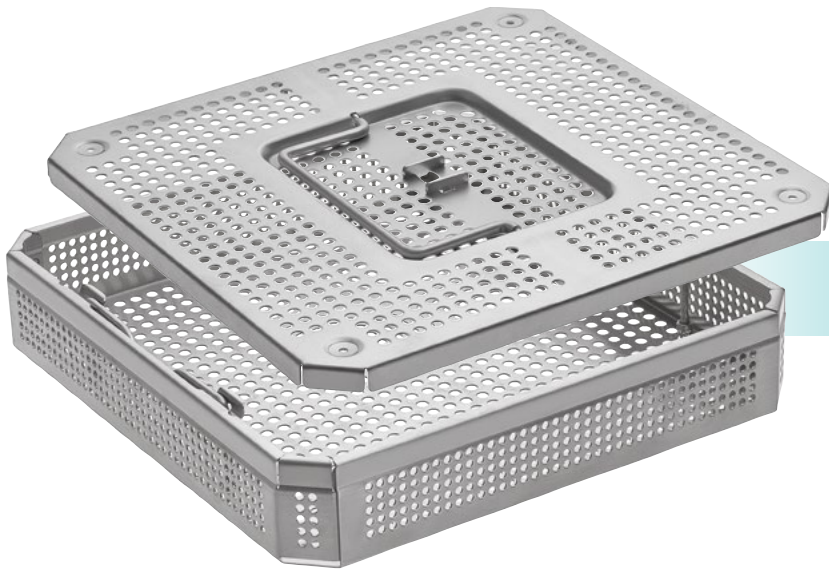

Stainless Steel Basket with round perforation, with lid

1/2
255mm length

- 600-255-535 255 x 245 x 35mm
- 600-255-555 255 x 245 x 55mm
- 600-255-575 255 x 245 x 75mm
- 600-255-605 255 x 245 x 105mm

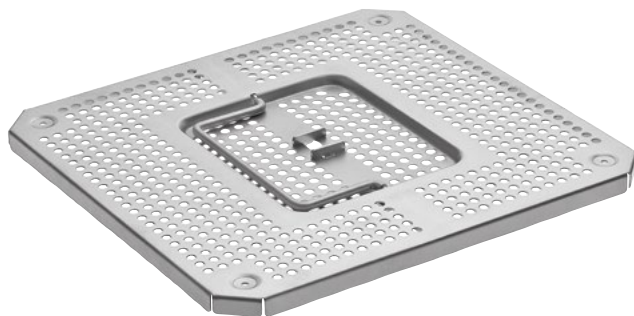

- Lid only
600-255-500 255 x 245mm



- Bottom only
600-255-530 255 x 245 x 30mm
600-255-550 255 x 245 x 50mm
600-255-565 255 x 245 x 70mm
600-255-600 255 x 245 x 100mm



600-281-001 Silicone Mat green, 220 x 230mm

- Integrated safety lid
- Ergonomic, noise-reduced handles
- Color matched lid and handles
- Increased stability due to reinforced container walls
- Safe fluctuation of air and steam thanks to integrated spring system



Folding front handle



Color-matched safety lid



Colored handles



Size (LxWxH)



| | | |
|-------------------|---------------|-------------|
| 580 x 280 x 100mm | ● 600-580-101 | 600-579-101 |
| | ● 600-580-102 | 600-579-102 |
| | ● 600-580-103 | 600-579-103 |
| | ● 600-580-104 | 600-579-104 |
| | ● 600-580-105 | 600-579-105 |
| | ● 600-580-106 | 600-579-106 |



| | | |
|-------------------|---------------|-------------|
| 580 x 280 x 135mm | ● 600-580-131 | 600-579-131 |
| | ● 600-580-132 | 600-579-132 |
| | ● 600-580-133 | 600-579-133 |
| | ● 600-580-134 | 600-579-134 |
| | ● 600-580-135 | 600-579-135 |
| | ● 600-580-136 | 600-579-136 |



| | | |
|-------------------|---------------|-------------|
| 580 x 280 x 150mm | ● 600-580-151 | 600-579-151 |
| | ● 600-580-152 | 600-579-152 |
| | ● 600-580-153 | 600-579-153 |
| | ● 600-580-154 | 600-579-154 |
| | ● 600-580-155 | 600-579-155 |
| | ● 600-580-156 | 600-579-156 |



| | | |
|-------------------|---------------|-------------|
| 580 x 280 x 200mm | ● 600-580-201 | 600-579-201 |
| | ● 600-580-202 | 600-579-202 |
| | ● 600-580-203 | 600-579-203 |
| | ● 600-580-204 | 600-579-204 |
| | ● 600-580-205 | 600-579-205 |
| | ● 600-580-206 | 600-579-206 |



| | | |
|-------------------|---------------|-------------|
| 580 x 280 x 260mm | ● 600-580-261 | 600-579-261 |
| | ● 600-580-262 | 600-579-262 |
| | ● 600-580-263 | 600-579-263 |
| | ● 600-580-264 | 600-579-264 |
| | ● 600-580-265 | 600-579-265 |
| | ● 600-580-266 | 600-579-266 |

Size (LxWxH)



| | | | |
|-------------------|---|-------------|-------------|
| 465 x 280 x 100mm | ● | 600-469-101 | 600-470-101 |
| | ● | 600-469-102 | 600-470-102 |
| | ● | 600-469-103 | 600-470-103 |
| | ● | 600-469-104 | 600-470-104 |
| | ● | 600-469-105 | 600-470-105 |
| | ● | 600-469-106 | 600-470-106 |



| | | | |
|-------------------|---|-------------|-------------|
| 465 x 280 x 135mm | ● | 600-469-131 | 600-470-131 |
| | ● | 600-469-132 | 600-470-132 |
| | ● | 600-469-133 | 600-470-133 |
| | ● | 600-469-134 | 600-470-134 |
| | ● | 600-469-135 | 600-470-135 |
| | ● | 600-469-136 | 600-470-136 |



| | | | |
|-------------------|---|-------------|-------------|
| 465 x 280 x 150mm | ● | 600-469-151 | 600-470-151 |
| | ● | 600-469-152 | 600-470-152 |
| | ● | 600-469-153 | 600-470-153 |
| | ● | 600-469-154 | 600-470-154 |
| | ● | 600-469-155 | 600-470-155 |
| | ● | 600-469-156 | 600-470-156 |

Size (LxWxH)



| | | |
|-------------------|---------------|-------------|
| 285 x 280 x 100mm | ● 600-280-101 | 600-279-101 |
| | ● 600-280-102 | 600-279-102 |
| | ● 600-280-103 | 600-279-103 |
| | ● 600-280-104 | 600-279-104 |
| | ● 600-280-105 | 600-279-105 |
| | ● 600-280-106 | 600-279-106 |



| | | |
|-------------------|---------------|-------------|
| 285 x 280 x 135mm | ● 600-280-131 | 600-279-131 |
| | ● 600-280-132 | 600-279-132 |
| | ● 600-280-133 | 600-279-133 |
| | ● 600-280-134 | 600-279-134 |
| | ● 600-280-135 | 600-279-135 |
| | ● 600-280-136 | 600-279-136 |



| | | |
|-------------------|---------------|-------------|
| 285 x 280 x 150mm | ● 600-280-151 | 600-279-151 |
| | ● 600-280-152 | 600-279-152 |
| | ● 600-280-153 | 600-279-153 |
| | ● 600-280-154 | 600-279-154 |
| | ● 600-280-155 | 600-279-155 |
| | ● 600-280-156 | 600-279-156 |



| | | |
|-------------------|---------------|-------------|
| 285 x 280 x 200mm | ● 600-280-201 | 600-279-201 |
| | ● 600-280-202 | 600-279-202 |
| | ● 600-280-203 | 600-279-203 |
| | ● 600-280-204 | 600-279-204 |
| | ● 600-280-205 | 600-279-205 |
| | ● 600-280-206 | 600-279-206 |



| | | |
|-------------------|---------------|-------------|
| 285 x 280 x 260mm | ● 600-280-261 | 600-279-261 |
| | ● 600-280-262 | 600-279-262 |
| | ● 600-280-263 | 600-279-263 |
| | ● 600-280-264 | 600-279-264 |
| | ● 600-280-265 | 600-279-265 |
| | ● 600-280-266 | 600-279-266 |



Identification label, 100 pieces per package
1 600-908-100 STANDARD
2 600-908-000 SMALL



600-909-000
 Plastic security seal,
 100 pieces per package



Identification label

with hole for snap hook
 56x17mm

with slot
 50x17mm

| | with hole for snap hook 56x17mm | with slot 50x17mm |
|----------|------------------------------------|----------------------|
| unmarked | 600-900-040 | 600-900-041 |
| | 600-900-050 | 600-900-051 |
| | 600-900-060 | 600-900-061 |
| | 600-900-070 | 600-900-071 |
| | 600-900-080 | 600-900-081 |
| | 600-900-090 | 600-900-091 |
| | 600-900-100 | 600-900-101 |
| | 600-900-108 | 600-900-109 |
| marked | 600-900-110 | 600-900-111 |
| | 600-900-120 | 600-900-121 |
| | 600-900-130 | 600-900-131 |
| | 600-900-140 | 600-900-141 |
| | 600-900-150 | 600-900-151 |
| | 600-900-160 | 600-900-161 |

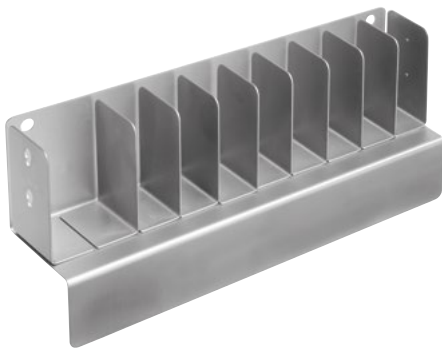

600-900-210
 Dispenser for identification labels
 (8 small compartments and 1 double compartment)
 as table or wall model



600-380-100
 PTFE (TEFLON) Filter, round, STANDARD



600-290-630
 Filter Dispenser for disposable Filter,
 round, 195x195mm



600-100-000
RZ-Aquajet
Water Jet Pistol complete
with 9 tips and 1m pressure
tubing, with strap and
suspension hook



700-900-160
Instrument Oil in 50ml bottle

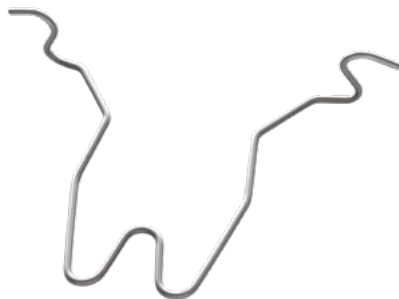

660-166-100
Holding Device for cleaning & sterilization

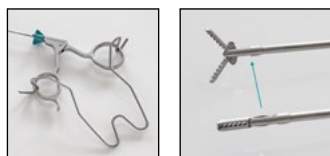

300-135-905
Cleaning brush for \varnothing 5mm, 500mm length (1 piece per box)



300-135-910
Cleaning brush for \varnothing 10mm, 500mm length (1 piece per box)



300-215-000
Cleaning brush, length 215mm, brush length 60mm, brush \varnothing 13mm



300-420-065
Cleaning brush, length 420mm, brush length 65mm, brush \varnothing 3mm



700-900-250
Oil Dispenser, 140mm



700-900-220
Special Cotton for polishing
metal sheaths and instruments

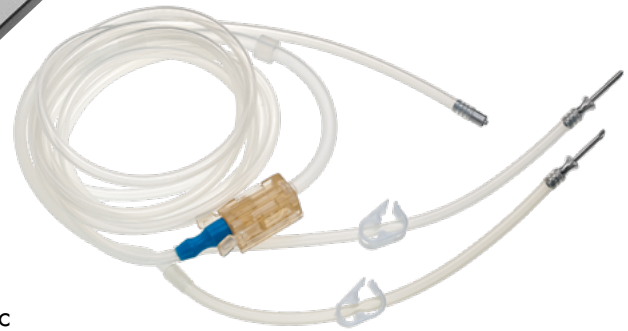

351-100-200 Basic Irrigation Pump P1

This unit offers all basic functions for irrigation in hysteroscopic surgery. Thanks to hydrostatic pressure regulation, the precise pressure in the treated body part is displayed. State-of-the-art and reliable technology features this versatile Pump.

Features:

- Irrigation Pump for Hysteroscopy
- Pump leveling adjustment
- Pressure controlled roller pump

Accessories (Hysteroscopy)

| | | | |
|-------------|---|-------------|----------|
| 253-910-001 | Irrigation Tubing Set, silicone, autoclavable | non-sterile | included |
| 253-910-002 | Irrigation Tubing Set, PVC, 20 pieces, daily tube | sterile | optional |
| 253-910-003 | Patient tube, PVC, 2.5m, 40 pieces | sterile | optional |

DELIVERY CONTAINS:

- Pump device
- Tubing set (225-910-001)
- Mains cable
- 2 Spare fuses
- Operating manual

Technical data

| | |
|------------------|--|
| Line voltage | 100-240 VAC |
| Power input | 80VA |
| Irrigation power | Arthroscopy: 0 - 1.5L/min Urology: 0 - 1.0L/min Hysteroscopy: 0 - 0.5L/min |
| Pressure range | Arthroscopy: 10 - 150mmHG Urology: 10 - 150mmHG Hysteroscopy: 10 - 200mmHG |
| Measurements | 380 x 130 x 400mm (WxHxD) |
| Weight | approx. 11kg |



351-100-300 HYS Pump Pro P5

P5 is a fluid irrigation pump to be used in endoscopic operations in the fields of hysteroscopy. It is equipped with a scale for fluid management. Hydrostatic pressure compensation procedure ensures correct pressure reading. Highest safety is ensured by air bubble detection.

351-100-201
Tubing Set included

Features:

- Advanced fluid management system for Hysteroscopy
- Compares input and output continuously to avoid fluid overload
- Liquid overflow is prevented automatically
- Scale for fluid management
- Hydrostatic pressure compensation - leveling function
- Acoustic and visual air bubbles warning system
- Safety parameters adjustable

Accessories

| | | | |
|-------------|---|-------------|----------|
| 351-100-201 | Tubing Set „Irrigation“, silicone, autoclavable | non-sterile | included |
| 351-100-202 | Irrigation Tubing Set, PVC, 20 pieces, daily tube | sterile | optional |
| 351-100-206 | Patient tube, PVC, 2.5m, 40 pieces | sterile | optional |
| 351-100-301 | Scale incl. mounting accessories | non-sterile | included |

Technical data

| | |
|----------------------------|---|
| Line voltage | 100-240 VAC |
| Power input | 80VA |
| Irrigation power | 0 - 0.500L/min |
| Pressure range | 10 - 200mmHG |
| Aspiration Bottle-Retainer | for 1 Liter = 0.34kg for 2 Liter = 0.44kg |
| Scale: | |
| Container volume | 0 - 9.9L |
| Fluid balance | 0 - 2.0L |
| Measurements | Device: 380 x 130 x 400mm (WxHxD) Scale: 270 x 270 x 400mm (WxHxD) |
| Weight | Device: approx. 11kg Scale: approx. 5kg (rated load up to 35kg) |

DELIVERY CONTAINS:

- Pump device (351-100-300)
- Irrigation Tubing Set (351-100-201)
- Scale (351-100-301)
- 2 Spare fuses • Mains Cable
- Screws • Suspension
- Operating manual

Powerful surgical suction unit for high demands. Designed for continuous operation, silent running, quick-mount mechanism for connection to system trolley without the use of tools, two vacuum attachments, easy to clean surfaces with additional protection against the penetration of liquids, integrated extra-large precision-vacuum indication, loss-free, infinitely variable ball-shaped vacuum regulator. DDS system for hose-free coupling of the pump to the DDS canister.



1 66-956-000
Mobile Suction Unit with 2 x 3 L canister
incl. Footswitch

Features

- Easy change-over from mobile to table-top unit
- Silent running
- Integrated vacuum indication
- Easy to clean

Delivery contains

- Basic Unit • Mains Cable • Operating Instructions
- 2 DDS Canisters 3L • 2 DDS Canister Lids
- 2 DDS Canister Handles • 2 DDS Splash Protections
- 10 DDS Bacterial Filters • DDS Hose Adapter Set
- DDS Holder on Canister • System Trolley
- DDS Change-Over Docking Station • Suction Hose
- Standard Rail Adapter • Footswitch

Technical data

| | |
|---------------------|--|
| Line Voltage | 230V (-50/60Hz) |
| Power consumption | max. 173W |
| Suction performance | 45L/min +3 / -5L/min max. -91kfa |
| Noise level | <48dB |
| Weight | 14.3kg |

DISTRIBUTED BY RZ MEDIZINTECHNIK



ATMOS Medizintechnik GmbH & Co. KG



300-001-902
Pressure Infusion Cuffs
with hand pump and pressure
proved manometer

- Transparent net
- Hanger fluid bag: can be replaced easily
- Pressure proved manometer: range from 0–300 mmHg
- Quick inflation thanks to large volume with release valve for pressure control



300-001-840 4K-3-Chip UHD-Camera K 4000

Features:

- 4K UHD resolution with 3-chip technology
- Image algorithm enhancement of color and structure
- 4K video recording
- 4K image saving
- Camera head with 4 programmable buttons
- Boost function
- Fog reduction
- Freeze function
- 2.5x digital zoom
- 10 USER mode configurations
- Multilingual on screen menu
- SDI 4K Output
- Text generator (optional with keyboard)

DELIVERY CONTAINS:

- Main Unit (300-001-840) • Camera head (300-001-841)
- HDMI cable • USB Pen Drive
- Mains cable • Operating manual

4K

**Ultra High Definition Quality
3840 x 2160 PIXELS**



Recording function on USB pen drive



Camera head with 4 raised push buttons



300-001-841
UHD 3-Chip Camera Head
(included in the set)



300-001-031
UHD 4K Monitor, 31", 4096 x 2160 pixels resolution



300-001-615
Title generator keyboard, waterproof IP68
US-Layout, cable 1.8m, color: grey,
305x140x15mm, 600gr.



300-001-610
Footswitch for HD Cameras
cable length: 2m

Technical data

| | |
|-------------------|-------------------------|
| Line Voltage | 100-240 VAC |
| Power consumption | 60VA |
| Image Sensor | 3 MOS |
| Resolution | 3840 x 2160 pixels (4K) |
| Index ratio | 16:9 |
| N/N ratio | 54db |

| | |
|---------------|---|
| Video outputs | 1x HDMI 4K 1x HDMI FullHD 1x SDI 4K 1x SDI FullHD |
| Dimensions | Control unit: 355 x 103 x 350mm (WxHxD) Weight control unit: 6.2kg Weight camera head: 145g |

Camera



Full HD recording function (F4 only)



USB pen drive included (F4 only)



Ergonomic high-end camera head included

| Order number | Description |
|--------------|---|
| 300-001-800 | 3 Chip HD-Camera F3 |
| 300-001-804 | 3 Chip HD-Camera F4 (with recording function) |

FULL HD

Features (F4):

- Full HD camera with 3-chip MOS technology
- Pure Natural Colors technology
- Full HD video recording
- Full HD image saving
- Camera head with 3 programmable buttons
- Boost function
- Freeze function
- 2.5x digital zoom
- 3 USER mode configurations
- Multilingual on screen menu
- Different digital video outputs
- Text generator (optional with keyboard)

DELIVERY CONTAINS:

- Main Unit (300-001-804)
- Camera head (300-001-802)
- YPbPr/RGB cable • 2x BNC cable • Jack Cable
- HDMI - DVI cable • HDMI cable • S-Video cable
- USB Pen Drive • Mains cable • Operating manual

Features (F3):

- Full HD camera with 3-chip MOS technology
- Pure Natural Color technology
- Camera head with 3 programmable buttons
- Boost function
- Freeze function
- 2.5x digital zoom
- 3 USER mode configurations
- Multilingual on screen menu
- Different digital video outputs
- Text generator (optional with keyboard)

DELIVERY CONTAINS:

- Main Unit (300-001-800)
- Camera head (300-001-802)
- YPbPr/RGB cable • 2x BNC cable • Jack Cable
- HDMI - DVI cable • HDMI cable • S-Video cable
- Mains cable • Operating manual

Camera



FULL HD



300-001-616 (optional) Title generator keyboard, waterproof IP68, US-Layout, USB Connector, cable 1.8m, Color: grey, 305x140x15mm, 600gr.



300-001-610 (optional) Footswitch for HD Cameras, cable length: 2m

300-001-802 (included) High-End 3-MOS Camera Head Full HD 1920 x 1080p

Technical data (F4)

| | |
|------------------|---|
| Line Voltage | 100-240 VAC |
| Power input | 20W |
| Image Sensor | 3 MOS |
| Resolution | 1920 x 1080 pixels (FullHD) |
| Image resolution | >1000 TV lines, horizontal |
| Index ratio | 16:9 |
| Min. sensitivity | < 3lx (1/1.4) |
| Video outputs | |
| Digital | 2 x HD SDI 1x HDMI / DVI 2x CVBS |
| Analog | 1 x YPbPr / RGB 1 x Y/C (Pal/NTSC) 1x CVBS (Pal/NTSC) |
| Shutter speed | 1/50 (1/60) to 1/100.000sec |
| Dimensions | Control unit: 380 x 120 x 360mm (WxHxD) Weight control unit: 11kg Weight camera head: 145g |

Technical data (F3)

| | |
|------------------|---|
| Line Voltage | 100-240 VAC |
| Power input | 20W |
| Image Sensor | 3 - Chip |
| Resolution | 1920 x 1080 pixels (FullHD) |
| Image resolution | >1000 TV lines, horizontal |
| Index ratio | 16:9 |
| Min. sensitivity | < 3lx (1/1.4) |
| Video outputs | 1 x HDMI / DVI 1 x YPbPr (Component) 1 x Y/C (Pal/NTSC) 1x CVBS (Pal/NTSC) |
| Shutter speed | 1/50 (1/60) to 1/100.000sec |
| Dimensions | Control unit: 380 x 120 x 360mm (WxHxD) Weight control unit: 11kg Weight camera head: 145g |

Camera



Full HD recording function
(F2 Pro only)



USB pen drive included
(F2 Pro only)



Ergonomic high-end
camera head included

| Order number | Description |
|--------------|--|
| 300-001-600 | HD-Camera F1 |
| 300-001-601 | HD-Camera F2 Pro (with recording function) |

FULL HD

Features (F2 Pro):

- Full HD camera with 1-chip MOS technology
- Natural color technology
- Full HD video recording
- Full HD image saving
- Camera head with 3 programmable buttons
- Boost function
- Freeze function
- 2.5x digital zoom
- 3 USER mode configurations
- Multilingual on screen menu
- HDMI video outputs
- Text generator (optional with keyboard)

DELIVERY CONTAINS:

- Main Unit (300-001-601)
- Camera head with 3m cable (300-001-602)
- YPbPr/RGB cable • 2x BNC cable
- HDMI - DVI cable • HDMI cable
- S-Video cable • Jack cable
- USB Pen Drive
- Operating manual
- Mains cable

Features (F1):

- Full HD camera with 1-chip MOS technology
- Natural color technology
- Camera head with 3 programmable buttons
- Boost function
- Freeze function
- 2.5x digital zoom
- 3 USER mode configurations
- Multilingual on screen menu
- HDMI video outputs
- Text generator (optional with keyboard)

DELIVERY CONTAINS:

- Main Unit (300-001-600)
- Camera head with 3m cable (300-001-602)
- YPbPr/RGB cable • 2x BNC cable
- HDMI - DVI cable • HDMI cable
- S-Video cable • Jack cable
- Operating manual
- Mains cable



300-001-602 High-End 1/3" MOS Camera
(included) Head Full HD 1920 x 1080p

FULL HD



300-001-616 Title generator keyboard, waterproof
(optional) IP68, US-Layout, USB Connector,
cable 1.8m, Color: grey,
305x140x15mm, 600gr.



300-001-610 Footswitch for HD Cameras,
(optional) cable length: 2m

Technical data (F2 Pro)

| | |
|------------------|--|
| Line Voltage | 100-240 VAC |
| Power input | 30W |
| Image Sensor | 1/3" MOS |
| Resolution | 1920 x 1080 pixels (FullHD) |
| Image resolution | >1000 TV lines, horizontal |
| Index ratio | 16:9 |
| Min. sensitivity | < 3lx (1/1.4) |
| Video outputs | 2 x HD SDI (optional) 1 x HDMI / DVI 1 x Y-Pb-Pr (Component) 1 x Video (PAL/NTSC) 1 x S-Video (PAL/NTSC) |
| Dimensions | Control unit: 380 x 120 x 360mm (WxHxD) Weight control unit: 11kg Weight camera head: 105g |

Technical data (F1)

| | |
|------------------|---|
| Line Voltage | 100-240 VAC |
| Power input | 20W |
| Image Sensor | 1/3" MOS |
| Resolution | 1920 x 1080 pixels (FullHD) |
| Image resolution | >1000 TV lines, horizontal |
| Index ratio | 16:9 |
| Min. sensitivity | < 3lx (1/1.4) |
| Video outputs | 1 x HDMI 1 x YPbPr / RGB 1 x S-Video (Y/C; Pal / NTSC) 1 x Video (CVBS; Pal / NTSC) |
| Dimensions | Control unit: 380 x 120 x 360mm (WxHxD) Weight control unit: 11kg Weight camera head: 105g |



| Order number | Description |
|--------------|-------------------------------------|
| 300-001-400 | Camera Z1 |
| 300-001-410 | Camera Z2 (with recording function) |

Features:

- Full HD camera with 1-chip technology
- Bright color technology
- Video and Picture recording (Z2 only)
- Camera head with 3 programmable buttons
- Freeze function
- 2.5x digital zoom
- 3 USER mode configurations
- Multilingual on screen menu

DELIVERY CONTAINS:

- Main Unit (300-001-410)
- Camera head (300-001-410.1)
- HDMI/DVI Cable
- HDMI cable
- 4GB USB Pen Drive (Z2 only)
- Mains cable
- Operating manual

Technical data

| | |
|--------------|---|
| Line Voltage | 100-240 VAC |
| Image Sensor | 1/3" MOS |
| Resolution | 1920 x 1080 pixels (FullHD) |
| Index ratio | 16:9 |
| Outputs | 1x HDMI |
| Connections | 1x USB (Z2 only), 1x Remote IN 2 x Remote OUT, 2x RJ45 |

| | |
|------------------------------|---|
| Safety Class (EN 60601-1) | I |
| Classification (EU 2017/745) | I |
| Application part | BF |
| Dimensions | Control Unit: 380 x 132 x 378 mm Camera Head: Ø38 x 79mm |
| Weight | Control Unit: approx. 9kg Camera Head: 180g |

TV COUPLER



4K
FULL HD

300-001-823 f=14mm
300-001-824 f=25mm
300-001-825 f=28mm
c-mount, soakable



4K
FULL HD

250-015-030
Zoom-TV-Adapter
f=15 - 30mm
c-mount, soakable



FULL HD

250-020-025 F=25mm (splitting 90/10)
250-020-030 F=30mm (splitting 90/10)
Beamsplitter, allows simultaneous video
and direct views, c-mount, soakable



FULL HD

300-001-813 f=14mm
300-001-814 f=25mm
300-001-815 f=28mm
c-mount, soakable



300-001-168
Endovue 32" HD Monitor

300-001-158
Endovue 24" HD Monitor

Technical data

| | |
|-------------------|--|
| Screen size | 32" / 24" diagonal |
| Resolution | 1920 x 1080 |
| Aspect ratio | 16:9 |
| Viewing angle | 178° |
| Numbers of colors | 16.7 Million (8-bit) |
| Video Inputs | DVI-D, RGBS/VGA/YPbPr (HD-15 or DVI-I via adapter), S-Video, Composite |
| Video Outputs | DVI-D |
| Weight | 8.8kg (300-001-168) 6.7kg (300-001-158) |



300-001-232
Radiance 32" HD Monitor

300-010-226
Radiance 27" HD Monitor

Technical data

| | |
|-------------------|---|
| Screen size | 32" / 27" diagonal |
| Resolution | 1920 x 1080 |
| Aspect ratio | 16:9 |
| Viewing angle | 178° |
| Numbers of colors | 1.07 Billion (10-bit) |
| Video Inputs | DVI-I and 3G-SDI Input/Output |
| Video Outputs | DVI-D |
| Weight | 11.0kg (300-001-232) 8.9kg (300-010-226) |



300-001-031
UHD 4K Monitor, 31"

Technical data

| | |
|------------------|--|
| Screen size | 31" diagonal |
| Resolution | 4096 x 2160 |
| Aspect ratio | 17:9 |
| Viewing angle | 178° |
| Number of colors | 1.08 Billion (10-bit) |
| Video Inputs | 1 x HDMI 2.0 1 x DP 1.2 (SST) & 1 x DP 1.2 (MST) 1 x DVI (single link), 4 x SDI (3G) |
| Video Outputs | 1 x DP 1.2 (SST) 1 x DVI (single link), 4 x SDI (3G) |
| Weight | 10.5kg |

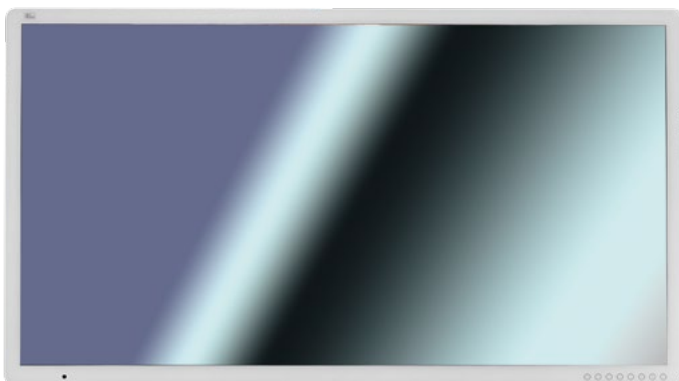

300-001-055
UHD 4K Monitor, 55"

Technical data

| | |
|-------------------|---|
| Screen size | 55" diagonal |
| Resolution | 3840 x 2160 |
| Aspect ratio | 16:9 |
| Viewing angle | 178° |
| Numbers of colors | 1.08 Billion (10-bit) |
| Video Inputs | 1 x HDMI 2.0, 2 x DP 1.2 (55T) 1 x DVI (single link), 2 x DVI (dual link) 4 x SOi (3G), 2 x SOi (12G) |
| Video Outputs | 1 x DVI (single link), 1 x DP 1.2 (SST) 4 x SDI (3G), 2x SDI (12G) |
| Weight | 37.35kg |

RZ MEDIA WORKSTATION Innovative Documentation System – the stand alone “all in one” solution

Sophisticated users get a comprehensive tool for creating, documenting and archiving of videos, pictures and findings. An extensive set of tools gives the ability for easy creation of individual and complex findings reports. Easy integration into IT-environment ensures an optimal workflow. The database provides long-term availability of picture findings with almost no capacity limitation.



300-001-199

RZ Medical Workstation PRO (with DICOM worklist)

300-001-198

RZ Medical Workstation (without DICOM worklist)

Features:

- Stand-alone device
- Recording of videos and pictures
- PACS support DICOM worklist/store
- Playing videos with abstraction of individual images
- Manual editing of comments for sessions and recordings
- Graphical marking tools
- Creation of reports incl. patient information, pictures, videos and comments
- Full-text search in data base
- User management including import, adaption and export of patients
- LIVE OR communication via e.g. Zoom, Skype or Teams
- Hospital Safety guidelines (Windows based network and firewall)





300-900-300 LUMEN LED 3 PRO Light Source, 110 - 230V

Features:

- 6500K daylight color temperature
- 375 Watt equivalent output power
- > 20.000 hours lifetime
- Turret connector for the most common light cables (Olympus, Wolf, Gyus ACMI, Storz)
- Manual or automatic light control
- Waterproof touch control panel
- Low heat conduction by improved LED technology
- Boost function: light increase of 20%



- A OLYMPUS
- B WOLF
- C GYRUS ACMI
- D STORZ

Turret, multi connector

Daylight quality

Strong light output
375W equivalent

Compatible to
different light cables

DELIVERY CONTAINS:

- Main Unit (300-900-300)
- BNC cable (optional)
- Mains cable
- Operating manual

Technical data

| | |
|------------------|--|
| Line Voltage | 100-240 VAC |
| Video input | 1x Video, BNC |
| Protection class | 1 (acc. IEC 60601-1) 1 (acc. MDD 93/42/EEC) |
| Safety class | BF |
| Standard | IEC 60601-1-2 |
| Dimensions | 380 x 120 x 360mm (WxHxD) |
| Weight | approx. 11kg |



300-900-180 LUMEN LED 1, 180W

Features:

- More than 20.000h lamp lifetime
- 180 Watt equivalent power output
- Manual or automatic light control
- Waterproof touch control panel
- Low heat conduction by improved LED technology
- Daylight color temperature 6000 – 6500° K for accurate color representation
- Boost function: light increase of 20%



Automatic or manual light intensity control



Digital light intensity display

Technical data

| | |
|-------------------|--|
| Line Voltage | 100-240 VAC |
| Power consumption | 130VA |
| Video input | 1x Video, 1x S-Video (Y/C) (automatic version only) |
| Protection class | 1 (acc. IEC 60601-1) 1 (acc. MDD 93/42/EEC) |
| Safety class | BF |
| Dimensions | 380 x 120 x 360mm (WxHxD) |
| Weight | approx. 11kg |

DELIVERY CONTAINS:

- Main Unit (300-900-180)
- BNC cable
- Mains cable
- Operating manual

Fiber optic light cable, without adapter pieces

| | |
|--------------|-------------------|
| 250-025-230 | Ø 2.5 mm, 2300 mm |
| 250-025-300 | Ø 2.5 mm, 3000 mm |
| 250-035-180 | Ø 3.5 mm, 1800 mm |
| 250-035-230 | Ø 3.5 mm, 2300 mm |
| 250-035-300 | Ø 3.5 mm, 3000 mm |
| 250-048-180 | Ø 4.8 mm, 1800 mm |
| 250-048-230* | Ø 4.8 mm, 2300 mm |
| 250-048-300 | Ø 4.8 mm, 3000 mm |



Adapter pieces for fiber light cable for use with telescope



250-042-000 RZ/Storz/Olympus



250-040-000 Wolf



250-041-000 ACMI/British Standard

Adapter pieces for fiber light cable for use with light source



250-039-000 RZ/Storz



250-037-000 Wolf



250-038-000 ACMI/British Standard /CUDA



250-044-000 Olympus



250-048-000 Luxtec



250-052-000 Heine



250-051-000 Stryker



250-059-000 Pentax



250-042-000
RZ/Storz/Olympus Telescope adapter



Ordering Example:
250-048-180 + 250-039-000
Fiber optic light cable + RZ/Storz light guide Adapter

COMPATIBILITY NOTE:

A fiber optic cable with a large diameter should not be connected to a smaller diameter scope.
For example: Ø 4.8mm fiber optic cables connected to a Ø 2.9mm may risk high temperature at the light entry of the endoscope and may risk patient safety.

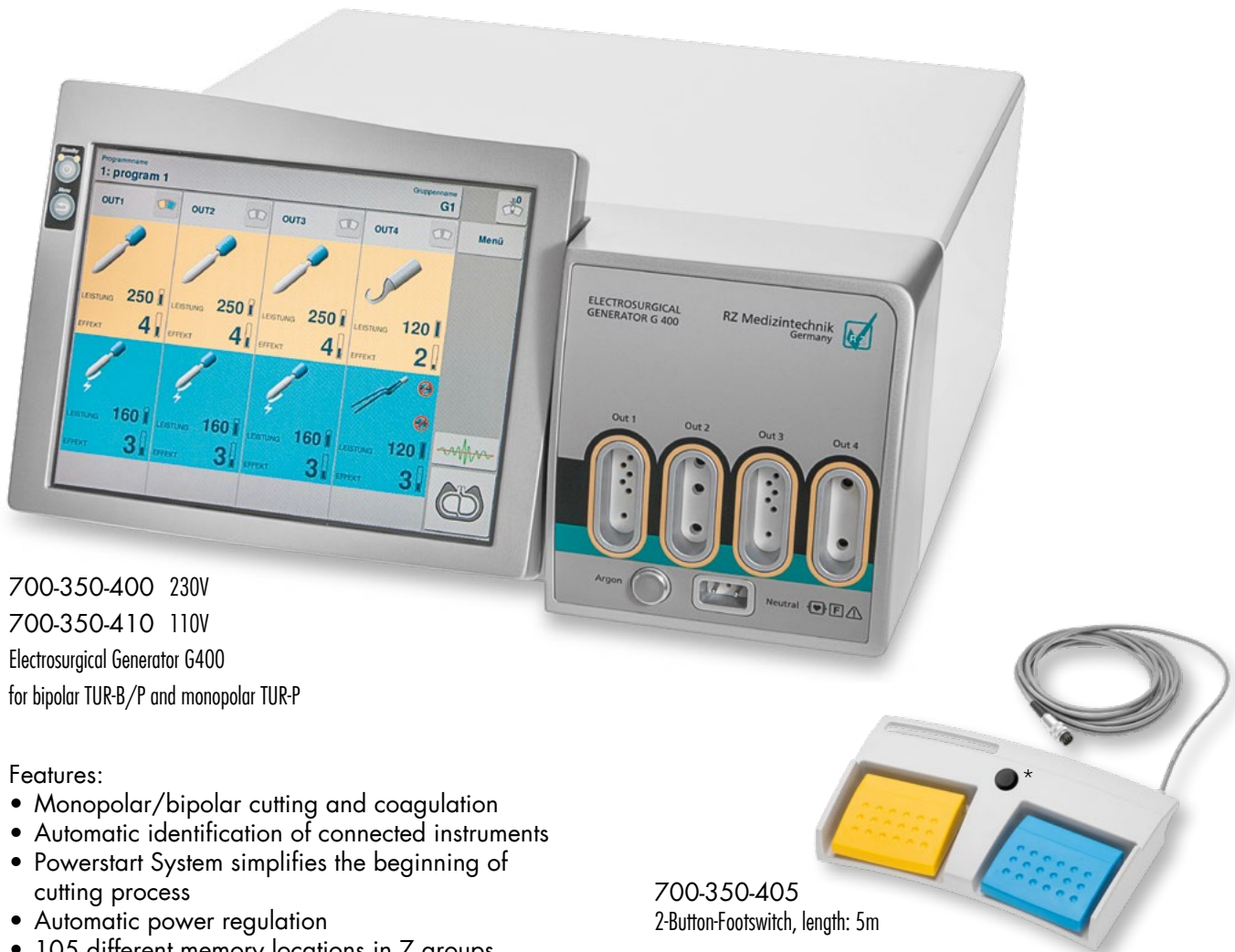

700-350-400 230V
 700-350-410 110V
 Electrosurgical Generator G400
 for bipolar TUR-B/P and monopolar TUR-P

Features:

- Monopolar/bipolar cutting and coagulation
- Automatic identification of connected instruments
- Powerstart System simplifies the beginning of cutting process
- Automatic power regulation
- 105 different memory locations in 7 groups
- Various output configuration of the sockets available
- 10" Touchscreen
- Tiltable display
- Footswitch (optional)
- Available with Argon and / or the RZeal
- Real-time output monitoring

700-350-405
 2-Button-Footswitch, length: 5m

700-350-402
 *2-Button-Footswitch and 1 Vario-Switch-Button, length: 5m

Technical data

| | |
|-----------------------------------|---|
| Line voltage | 110-230 VAC |
| Power consumption | 500W |
| Generator operation frequency | 333kHz |
| Display | TFT 10" |
| Defibrillation impulse resistance | acc. to EN 60601-1 |
| NEM system | neutral electrode control optical indication 7 levels required resistance < 240 Ω |
| Gas type | pure argon 4.8 (99,998%) or higher |
| Inlet gas pressure | 0.25-0.4 [MPa] |

| | |
|-----------------------|---|
| Gas outflow | 0.1-10 l/min, regulated 0.1 l/min in whole range |
| Pressure range | reducer (0.4 MPa) on argon cylinder |
| Vessel sealing system | 9 effects/300W |
| AutoStop | automatic stop of sealing process after achieving the optimal effect |
| Dimensions | 495 x 415 x 225mm (LxWxH) |
| Weight | 12.2kg |



HYSTEROSCOPY

HF Generator

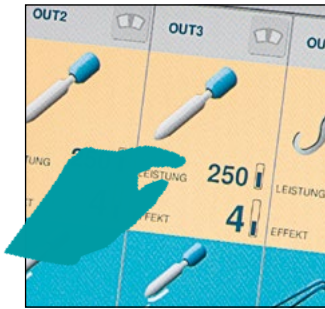

10" Touchscreen



Easy readable interface design

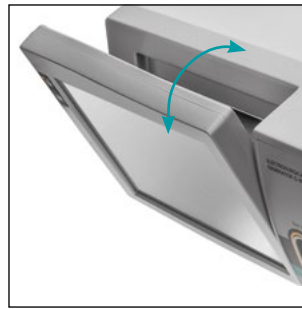

Tiltable display



Instrument detecting sockets

Cutting and Coagulation features

MONOPOLAR CUTTING

| | |
|---------------|----------------|
| Mono Cut | 9 effects/350W |
| Precise Cut | 9 effects/50W |
| Mixed Cut | 9 effects/150W |
| Polipo Cut** | 9 levels |
| Papillo Cut** | 9 levels |
| Arthro Cut** | 9 levels |
| Uro Cut** | 9 levels |
| Hystero Cut** | 9 levels |
| Argon Cut** | 9 effects/350W |

BIPOLAR CUTTING

| | |
|-----------------|----------------|
| Bi-Cut** | 9 effects/120W |
| Uro Bi-Cut** | 9 levels |
| Arthro Bi-Cut** | 9 levels |

MONOPOLAR COAGULATION

| | |
|-----------------|----------------|
| Soft Coag | 9 effects/200W |
| Forced Coag | 9 effects/200W |
| Spray Coag | 80W |
| Hybrid Coag | 9 effects/200W |
| Standard Argon* | 80W |
| Endo Argon* | 40W |
| Pulse Argon* | 40W |
| Uro Coag** | 9 levels |
| Arthro Coag** | 9 levels |
| Hystero Coag** | 9 levels |

BIPOLAR COAGULATION

| | |
|------------------|--------------------------------------|
| Soft Bi-Coag | 9 effects/120W AutoStart/AutoStop |
| Forced Bi-Coag | 9 effects/120W AutoStop |
| Uro Bi-Coag** | 9 levels |
| Arthro Bi-Coag** | 9 levels |
| Sciss Bi-Coag** | 9 levels |



700-503-003
Cable for Disposable Neutral Electrode
5m, only RZ compatible



700-503-000 Adults
700-503-001 Children
Disposable Neutral Electrode
hydrogel, split, for adults or children
10x5 pcs. per package

Modifications of technical specification or design are subject to change without prior notice.

* available only for Argon version

** special made available only for dedicated SDS cable/instrument connected



700-340-400 230V
 700-340-410 110V
 Electrosurgical Generator G44

Features:

- Monopolar/bipolar cutting and coagulation
- Automatic instrument detection system
- Intuitive Touchscreen
- Automatic power regulation
- Configurable working modes
- Real-time parameter control
- Special endoscopic modes
- Bipolar resection
- Easy software update



700-503-003
 Cable for Disposable Neutral Electrode
 5m, only RZ compatible



700-350-405
 2-Button-Footswitch, length: 5m
 700-350-402
 *2-Button-Footswitch and 1 Vario-Switch-Button, length: 5m



700-503-000 Adults
 700-503-001 Children
 Disposable Neutral Electrode
 hydrogel, split, for adults or children
 10x5 pcs. per package

| | |
|-------------------------|--|
| Display | TFT 7" WVGA |
| SpectrumResult system | automatic power regulation |
| Length / Width / Height | 385mm / 305mm / 141mm |
| Weight | 7kg |
| Power Supply Voltage | 220-240 V ± 10% 50/60 Hz or 110-120 V ± 10% 50/60 Hz |
| Rated power input | 1100 VA |

Safety features

| | |
|-----------------------------------|--|
| Protection against electric shock | I / CF |
| Low-frequency leakage currents | according to IEC 60601-1 |
| High-frequency leakage currents | according to IEC 60601-2-2 |
| Generator operation frequency | 333 kHz |
| Defibrillation impulse resistance | according to IEC 60601-1 |
| NEM System | neutral electrode control, optical indication, required resistance < 240 Ω |

Monopolar Coagulation max. 200W (200 Ω)

| | |
|--------------|------------------|
| Soft Coag | 9 effects |
| Forced Coag | 9 effects |
| Spray Coag | 80 effects / 80W |
| Hybrid Coag | 9 effects |
| Uro Coag | 9 effects |
| Hystero Coag | 9 effects |

Monopolar Cutting max. 400W (100 Ω)

| | |
|-------------|-----------|
| Mono-Cut | |
| Precise Cut | |
| Mixed Cut | 9 effects |
| Uro Cut | |
| Hystero Cut | |

Bipolar Coagulation max. 400W (25 Ω)

| | |
|----------------|--------------------------------|
| Soft Bi-Coag | 9 effects AutoStart / AutoStop |
| Forced Bi-Coag | 9 effects AutoStop |
| Uro Bi-Coag | 9 effects |
| Sciss Bi-Coag | 9 effects |

Bipolar Cutting max. 330W (150 Ω)

| | |
|------------|-----------|
| Bi-Cut | 9 effects |
| Uro Bi-Cut | 9 effects |



HYSTEROSCOPY

Numerical Index

| Order number | Page | Order number | Page | Order number | Page | Order number | Page |
|--------------|------------|--------------|--------|--------------|------------|--------------|--------|
| 166-956-000 | 60 | 253-324-225 | 40 | 300-001-602 | 67 | 300-900-300 | 73 |
| 225-910-001 | 58 | 253-325-225 | 40 | 300-001-610 | 63, 65, 67 | 301-701-100 | 13, 40 |
| 250-015-036 | 69 | 253-326-225 | 40 | 300-001-615 | 63 | 320-721-080 | 40 |
| 250-020-025 | 69 | 253-327-225 | 40 | 300-001-616 | 65, 67 | 320-721-100 | 40 |
| 250-020-030 | 69 | 253-328-225 | 40 | 300-001-800 | 64 | 320-721-120 | 40 |
| 250-022-025 | 69 | 253-329-225 | 40 | 300-001-802 | 65 | 320-721-140 | 40 |
| 250-022-030 | 69 | 253-330-225 | 40 | 300-001-804 | 3, 64 | 320-721-160 | 40 |
| 250-025-230 | 75 | 253-331-225 | 40 | 300-001-813 | 3, 69 | 320-721-180 | 40 |
| 250-025-300 | 75 | 253-332-225 | 40 | 300-001-814 | 69 | 320-721-200 | 40 |
| 250-035-180 | 75 | 253-333-225 | 40 | 300-001-815 | 69 | 320-721-220 | 40 |
| 250-035-230 | 3, 75 | 253-334-225 | 40 | 300-001-840 | 62 | 320-721-240 | 40 |
| 250-035-300 | 75 | 253-335-225 | 40 | 300-001-841 | 63 | 350-158-003 | 38 |
| 250-037-000 | 75 | 253-336-225 | 40 | 300-001-842 | 62 | 350-400-250 | 37, 38 |
| 250-038-000 | 75 | 253-337-225 | 40 | 300-001-902 | 61 | 350-660-100 | 36 |
| 250-039-000 | 3, 75 | 253-400-200 | 29 | 300-001-999 | 3 | 350-660-111 | 36 |
| 250-040-000 | 75 | 253-400-201 | 24, 29 | 300-010-226 | 3, 70 | 350-660-112 | 36 |
| 250-041-000 | 75 | 253-400-202 | 29 | 300-011-178 | 13, 40 | 350-660-113 | 36 |
| 250-042-000 | 3, 75 | 253-400-203 | 24, 29 | 300-011-179 | 13, 40 | 350-660-114 | 36 |
| 250-044-000 | 75 | 253-400-204 | 29 | 300-011-181 | 13, 40 | 350-660-115 | 36 |
| 250-048-000 | 75 | 253-400-205 | 24, 29 | 300-011-184 | 13, 40 | 350-660-116 | 36 |
| 250-048-180 | 75 | 253-400-211 | 29 | 300-011-506 | 13, 40 | 350-740-000 | 37 |
| 250-048-230 | 75 | 253-400-602 | 33 | 300-032-015 | 38 | 350-740-005 | 37 |
| 250-048-300 | 75 | 253-570-005 | 18 | 300-033-010 | 38 | 350-740-006 | 37 |
| 250-051-000 | 75 | 253-610-001 | 19, 33 | 300-042-005 | 38 | 350-740-007 | 37 |
| 250-052-000 | 75 | 253-610-002 | 19, 33 | 300-042-010 | 38 | 350-740-040 | 37 |
| 250-059-000 | 75 | 253-610-003 | 19, 33 | 300-110-711 | 37 | 350-740-050 | 37 |
| 253-000-084 | 28 | 253-610-004 | 19, 33 | 300-110-712 | 37 | 350-740-060 | 37 |
| 253-000-094 | 24, 28 | 300-001-031 | 63, 71 | 300-110-714 | 37 | 350-740-070 | 37 |
| 253-000-256 | 24, 28, 32 | 300-001-055 | 71 | 300-110-715 | 37 | 350-740-080 | 37 |
| 253-000-266 | 28 | 300-001-158 | 70 | 300-135-905 | 57 | 350-752-001 | 35 |
| 253-000-356 | 32 | 300-001-168 | 70 | 300-135-910 | 57 | 350-752-320 | 35 |
| 253-000-400 | 24, 27 | 300-001-198 | 72 | 300-215-000 | 57 | 350-752-420 | 35 |
| 253-000-401 | 24, 27 | 300-001-199 | 72 | 300-400-900 | 40 | 350-753-001 | 35 |
| 253-300-999 | 20, 24 | 300-001-232 | 70 | 300-400-901 | 40 | 350-753-320 | 35 |
| 253-320-225 | 40 | 300-001-400 | 68 | 300-420-065 | 57 | 350-753-420 | 35 |
| 253-321-225 | 40 | 300-001-410 | 68 | 300-860-100 | 19 | 350-754-000 | 34 |
| 253-322-225 | 40 | 300-001-600 | 66 | 300-860-111 | 19 | 350-754-001 | 34 |
| 253-323-225 | 40 | 300-001-601 | 66 | 300-900-180 | 3, 74 | 350-754-002 | 34 |



HYSTEROSCOPY

Numerical Index

| Order number | Page | Order number | Page | Order number | Page | Order number | Page |
|--------------|--------|--------------|--------|--------------|------------------------|--------------|---------------------------|
| 350-754-003 | 34 | 351-118-305 | 2, 15 | 351-400-605 | 33 | 351-829-012 | 22 |
| 350-755-007 | 38 | 351-118-335 | 15 | 351-400-630 | 10 | 351-829-030 | 2, 6, 7, 8, 9, 10, 20, 22 |
| 350-755-011 | 38 | 351-119-305 | 15 | 351-400-743 | 9 | 351-829-130 | 6, 7, 8, 10 |
| 350-755-017 | 38 | 351-119-335 | 15 | 351-400-750 | 9 | 351-900-902 | 2 |
| 351-000-180 | 20, 23 | 351-120-205 | 16 | 351-410-325 | 17 | 351-900-906 | 3 |
| 351-000-185 | 20, 23 | 351-120-235 | 16 | 351-410-327 | 17 | 351-900-911 | 20 |
| 351-000-201 | 20, 23 | 351-120-305 | 2, 15 | 351-410-425 | 17 | 351-900-912 | 24 |
| 351-000-202 | 23 | 351-120-335 | 15 | 351-410-427 | 17 | 351-905-105 | 2, 8, 13, 40 |
| 351-000-203 | 20, 23 | 351-124-105 | 17 | 351-500-040 | 6 | 351-905-110 | 13 |
| 351-000-205 | 20, 23 | 351-124-135 | 17 | 351-500-050 | 11 | 600-100-000 | 57 |
| 351-000-206 | 23 | 351-125-105 | 2, 17 | 351-500-054 | 11 | 600-255-500 | 50 |
| 351-000-400 | 32 | 351-125-135 | 17 | 351-500-060 | 12 | 600-255-530 | 50 |
| 351-000-401 | 32 | 351-126-305 | 2, 15 | 351-500-065 | 11 | 600-255-535 | 50 |
| 351-000-410 | 31 | 351-126-335 | 15 | 351-500-070 | 12 | 600-255-550 | 50 |
| 351-000-415 | 31 | 351-230-040 | 6 | 351-500-160 | 12 | 600-255-555 | 50 |
| 351-000-420 | 31 | 351-300-037 | 7 | 351-500-170 | 12 | 600-255-565 | 50 |
| 351-000-500 | 32 | 351-300-040 | 6 | 351-530-040 | 6 | 600-255-575 | 50 |
| 351-000-501 | 32 | 351-300-050 | 7 | 351-530-050 | 11 | 600-255-600 | 50 |
| 351-000-600 | 32 | 351-330-040 | 6 | 351-630-050 | 11 | 600-255-605 | 50 |
| 351-000-601 | 32 | 351-360-005 | 2, 18 | 351-720-000 | 4 | 600-279-101 | 55 |
| 351-100-200 | 3, 58 | 351-360-015 | 2, 18 | 351-720-030 | 4, 5 | 600-279-102 | 55 |
| 351-100-201 | 58, 59 | 351-370-105 | 2, 18 | 351-720-200 | 4 | 600-279-103 | 55 |
| 351-100-202 | 58, 59 | 351-380-360 | 18 | 351-720-300 | 4 | 600-279-104 | 55 |
| 351-100-205 | 16 | 351-385-360 | 18 | 351-720-500 | 4 | 600-279-105 | 55 |
| 351-100-206 | 58, 59 | 351-400-037 | 7 | 351-720-550 | 5 | 600-279-106 | 55 |
| 351-100-235 | 16 | 351-400-040 | 5, 10 | 351-720-600 | 4 | 600-279-131 | 55 |
| 351-100-300 | 59 | 351-400-043 | 8 | 351-720-650 | 5 | 600-279-132 | 55 |
| 351-100-301 | 59 | 351-400-050 | 8 | 351-804-000 | 11 | 600-279-133 | 55 |
| 351-100-305 | 2, 15 | 351-400-055 | 5, 10 | 351-804-012 | 26, 32 | 600-279-134 | 55 |
| 351-100-335 | 15 | 351-400-100 | 5, 10 | 351-804-030 | 11, 12, 24, 26, 27, 32 | 600-279-135 | 55 |
| 351-115-305 | 15 | 351-400-143 | 2, 8 | 351-815-012 | 39 | 600-279-136 | 55 |
| 351-115-335 | 15 | 351-400-150 | 2, 8 | 351-815-016 | 39 | 600-279-151 | 55 |
| 351-116-205 | 16 | 351-400-200 | 20, 23 | 351-815-020 | 39 | 600-279-152 | 55 |
| 351-116-235 | 16 | 351-400-201 | 20, 23 | 351-815-118 | 39 | 600-279-153 | 55 |
| 351-116-305 | 2, 15 | 351-400-410 | 30 | 351-815-132 | 39 | 600-279-154 | 55 |
| 351-116-335 | 15 | 351-400-415 | 30 | 351-815-160 | 39 | 600-279-155 | 55 |
| 351-117-305 | 2, 15 | 351-400-420 | 30 | 351-829-000 | 6 | 600-279-156 | 55 |
| 351-117-335 | 15 | 351-400-430 | 30 | | | | |



HYSTEROSCOPY

Numerical Index

| Order number | Page | Order number | Page | Order number | Page | Order number | Page |
|--------------|------|--------------|------------|--------------|------------|--------------|------|
| 600-279-201 | 55 | 600-280-263 | 55 | 600-469-155 | 54 | 600-540-535 | 47 |
| 600-279-202 | 55 | 600-280-264 | 55 | 600-469-156 | 54 | 600-540-550 | 47 |
| 600-279-203 | 55 | 600-280-265 | 55 | 600-470-101 | 54 | 600-540-555 | 47 |
| 600-279-204 | 55 | 600-280-266 | 55 | 600-470-102 | 54 | 600-540-570 | 47 |
| 600-279-205 | 55 | 600-281-001 | 50 | 600-470-103 | 54 | 600-540-575 | 47 |
| 600-279-206 | 55 | 600-281-002 | 49 | 600-470-104 | 54 | 600-540-600 | 47 |
| 600-279-261 | 55 | 600-281-003 | 20, 24, 48 | 600-470-105 | 54 | 600-540-605 | 47 |
| 600-279-262 | 55 | 600-281-004 | 47 | 600-470-106 | 54 | 600-579-101 | 53 |
| 600-279-263 | 55 | 600-290-630 | 56 | 600-470-131 | 54 | 600-579-102 | 53 |
| 600-279-264 | 55 | 600-292-052 | 41 | 600-470-132 | 54 | 600-579-103 | 53 |
| 600-279-265 | 55 | 600-380-100 | 56 | 600-470-133 | 54 | 600-579-104 | 53 |
| 600-279-266 | 55 | 600-405-500 | 49 | 600-470-134 | 54 | 600-579-105 | 53 |
| 600-280-101 | 55 | 600-405-530 | 49 | 600-470-135 | 54 | 600-579-106 | 53 |
| 600-280-102 | 55 | 600-405-535 | 49 | 600-470-136 | 54 | 600-579-131 | 53 |
| 600-280-103 | 55 | 600-405-550 | 49 | 600-470-151 | 54 | 600-579-132 | 53 |
| 600-280-104 | 55 | 600-405-555 | 49 | 600-470-152 | 54 | 600-579-133 | 53 |
| 600-280-105 | 55 | 600-405-570 | 49 | 600-470-153 | 54 | 600-579-134 | 53 |
| 600-280-106 | 55 | 600-405-575 | 49 | 600-470-154 | 54 | 600-579-135 | 53 |
| 600-280-131 | 55 | 600-405-600 | 49 | 600-470-155 | 54 | 600-579-136 | 53 |
| 600-280-132 | 55 | 600-405-605 | 49 | 600-470-156 | 54 | 600-579-151 | 53 |
| 600-280-133 | 55 | 600-462-052 | 41 | 600-485-500 | 48 | 600-579-152 | 53 |
| 600-280-134 | 55 | 600-464-229 | 42 | 600-485-530 | 48 | 600-579-153 | 53 |
| 600-280-135 | 55 | 600-469-101 | 54 | 600-485-535 | 48 | 600-579-154 | 53 |
| 600-280-136 | 55 | 600-469-102 | 54 | 600-485-550 | 48 | 600-579-155 | 53 |
| 600-280-151 | 55 | 600-469-103 | 54 | 600-485-555 | 20, 24, 48 | 600-579-156 | 53 |
| 600-280-152 | 55 | 600-469-104 | 54 | 600-485-570 | 48 | 600-579-201 | 53 |
| 600-280-153 | 55 | 600-469-105 | 54 | 600-485-575 | 48 | 600-579-202 | 53 |
| 600-280-154 | 55 | 600-469-106 | 54 | 600-485-600 | 48 | 600-579-203 | 53 |
| 600-280-155 | 55 | 600-469-131 | 54 | 600-485-605 | 48 | 600-579-204 | 53 |
| 600-280-156 | 55 | 600-469-132 | 54 | 600-501-000 | 44 | 600-579-205 | 53 |
| 600-280-201 | 55 | 600-469-133 | 54 | 600-501-002 | 43 | 600-579-206 | 53 |
| 600-280-202 | 55 | 600-469-134 | 54 | 600-505-000 | 43 | 600-579-261 | 53 |
| 600-280-203 | 55 | 600-469-135 | 54 | 600-505-002 | 42 | 600-579-262 | 53 |
| 600-280-204 | 55 | 600-469-136 | 54 | 600-506-002 | 43 | 600-579-263 | 53 |
| 600-280-205 | 55 | 600-469-151 | 54 | 600-508-000 | 45 | 600-579-264 | 53 |
| 600-280-206 | 55 | 600-469-152 | 54 | 600-511-000 | 46 | 600-579-265 | 53 |
| 600-280-261 | 55 | 600-469-153 | 54 | 600-540-500 | 47 | 600-579-266 | 53 |
| 600-280-262 | 55 | 600-469-154 | 54 | 600-540-530 | 47 | 600-580-101 | 53 |

| Order number | Page | | | | |
|--------------|------|-------------|-------|-------------|----------------|
| 600-580-102 | 53 | 600-900-081 | 56 | 700-340-410 | 78 |
| 600-580-103 | 53 | 600-900-090 | 56 | 700-350-030 | 19 |
| 600-580-104 | 53 | 600-900-091 | 56 | 700-350-050 | 19 |
| 600-580-105 | 53 | 600-900-100 | 56 | 700-350-130 | 19 |
| 600-580-106 | 53 | 600-900-101 | 56 | 700-350-150 | 19 |
| 600-580-131 | 53 | 600-900-108 | 56 | 700-350-400 | 76 |
| 600-580-132 | 53 | 600-900-109 | 56 | 700-350-402 | 78 |
| 600-580-133 | 53 | 600-900-110 | 56 | 700-350-404 | 77 |
| 600-580-134 | 53 | 600-900-111 | 56 | 700-350-405 | 77, 78 |
| 600-580-135 | 53 | 600-900-120 | 56 | 700-350-410 | 76 |
| 600-580-136 | 53 | 600-900-121 | 56 | 700-350-420 | 76 |
| 600-580-151 | 53 | 600-900-130 | 56 | 700-350-430 | 76 |
| 600-580-152 | 53 | 600-900-131 | 56 | 700-351-031 | 19 |
| 600-580-153 | 53 | 600-900-140 | 56 | 700-351-051 | 19 |
| 600-580-154 | 53 | 600-900-141 | 56 | 700-351-131 | 19 |
| 600-580-155 | 53 | 600-900-150 | 56 | 700-351-151 | 19 |
| 600-580-156 | 53 | 600-900-151 | 56 | 700-500-300 | 19, 77 |
| 600-580-201 | 53 | 600-900-160 | 56 | 700-500-453 | 20, 24 |
| 600-580-202 | 53 | 600-900-161 | 56 | 700-500-500 | 19, 77 |
| 600-580-203 | 53 | 600-900-210 | 56 | 700-501-300 | 77 |
| 600-580-204 | 53 | 600-908-000 | 56 | 700-501-453 | 19, 20, 24, 33 |
| 600-580-205 | 53 | 600-908-100 | 56 | 700-501-500 | 77 |
| 600-580-206 | 53 | 600-909-000 | 56 | 700-503-000 | 20, 24, 79 |
| 600-580-261 | 53 | 700-100-101 | 19 | 700-503-001 | 79 |
| 600-580-262 | 53 | 700-100-130 | 19 | 700-503-002 | 77 |
| 600-580-263 | 53 | 700-100-150 | 19 | 700-503-003 | 20, 24, 77 |
| 600-580-264 | 53 | 700-101-001 | 19 | 700-504-000 | 77, 79 |
| 600-580-265 | 53 | 700-101-130 | 19 | 700-801-100 | 77 |
| 600-580-266 | 53 | 700-101-150 | 19 | 700-801-900 | 77 |
| 600-900-040 | 56 | 700-200-130 | 19 | 700-900-149 | 57 |
| 600-900-041 | 56 | 700-200-150 | 19 | 700-900-160 | 57 |
| 600-900-050 | 56 | 700-287-030 | 19 | 700-900-220 | 57 |
| 600-900-051 | 56 | 700-287-050 | 19 | 700-900-250 | 57 |
| 600-900-060 | 56 | 700-287-130 | 19 | | |
| 600-900-061 | 56 | 700-287-150 | 19 | | |
| 600-900-070 | 56 | 700-300-003 | 19 | | |
| 600-900-071 | 56 | 700-300-005 | 19 | | |
| 600-900-080 | 56 | 700-340-400 | 3, 78 | | |

